

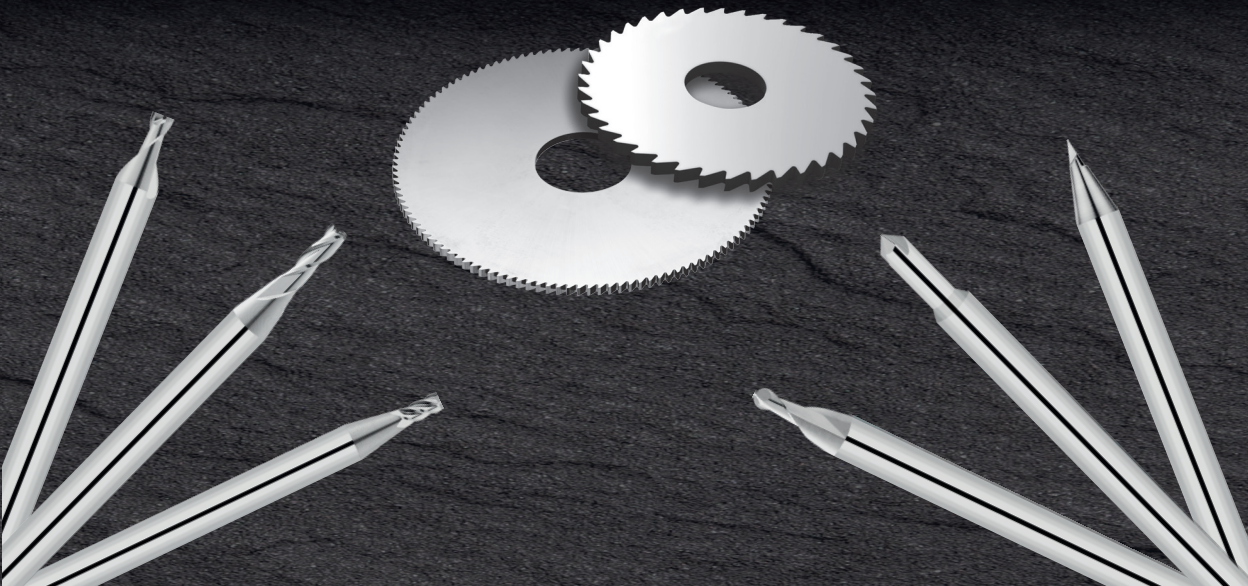

Alfa **tool**

SWISS  MADE





Alfa Tool

SWISS  MADE

LA RÉFÉRENCE POUR VOS OUTILS DE COUPE
DIE REFERENZ FÜR IHRE SCHNEIDWERKZEUGE
THE REFERENCE FOR YOUR CUTTING TOOLS

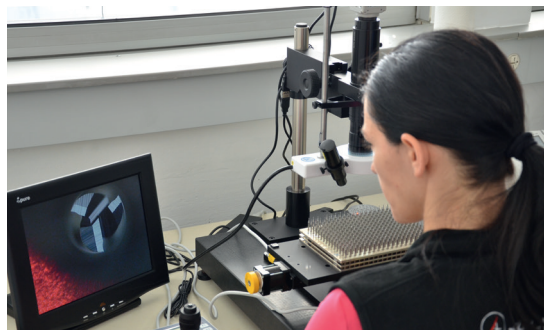

www.alfatool.ch



Fraises à graver
Gravierfräser
Engraving mills



1

Centreurs / Forets
Zentrierbohrer / Bohrer
Centering drills / Drills



2

Micro-fraises
Mikropräzisionsfräser
Micro end mills



3

Fraises en bout
Schaftfräser
End mills



4

Outils spéciaux sur demande
Sonderwerkzeuge auf Anfrage
Special tools on request

5

Fraises circulaires / Tasseaux
Kreissägeblätter / Fräsdorne
Slitting saws / Milling arbors

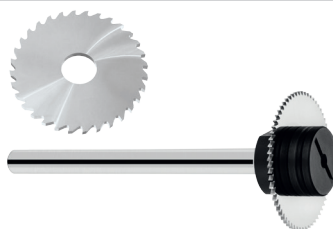

6

Informations techniques et symboles
Technische Informationen und Symbole
Technical information and symbols

7

Conditions générales de vente et de livraison / Répertoire des articles
Verkaufs- und Lieferbedingungen / Artikelverzeichnis
General terms of sale and delivery / Index of items

8

2000

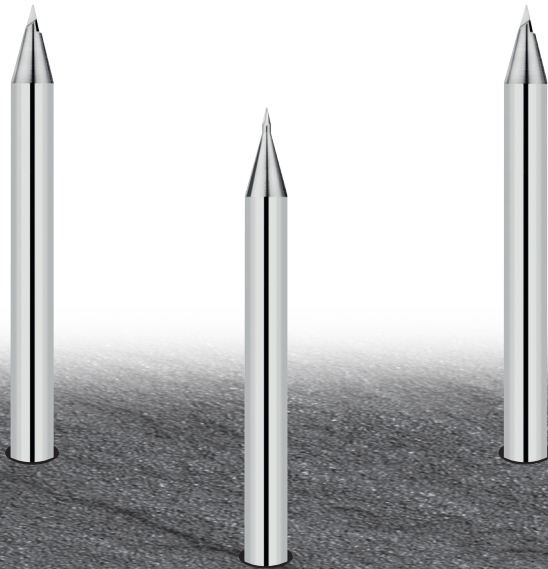

Rubrique		Corps	Angle	Plat / Rayon	Page
Rubrik		Schaft	Winkel	Fläche / Radius	Seite
Section		Shank	Angle	Flat / Radius	Page
Paramètres					
Schnittwerte					1.02
Data					
Fraises à graver avec plat	MD	Ø3h4	30° / 35° / 40° / 45° / 50° 55° / 60° / 65° / 70° / 90°	0.02-0.10 / 0.10-0.30	1.03
Gravierfräser mit Fläche	VHM				
Engraving mills with flat	HM				
Fraises à graver à rayon	MD	Ø3h4	30° / 35° / 40° / 45° / 50° 55° / 60° / 65° / 70° / 90°	0.04-0.10 / 0.10-0.30	1.04
Gravierfräser mit Radius	VHM				
Engraving mills with radius	HM				
Fraises à graver renforcées	MD	Ø3h4	30° / 35° / 40° / 45° / 50° 55° / 60° / 65° / 70° / 90°	0.04-0.10 / 0.10-0.30	1.05
Verstärkte Gravierfräser	VHM				
Reinforced engraving mills	HM				

Matière Werkstoff Material	Lubrifiant* Kühlung* Coolant*	Vf ** [mm/min]	Non revêtu Unbeschichtet Uncoated	Revêtu Beschichtet Coated
Acier inoxydable Rostfreier Stahl Stainless steel	O / E	70 - 150	-	++
Acier Stahl <700 N/mm ² Steel	O / E	80 - 180	+	++
Acier Stahl >700 N/mm ² Steel	O / E	70 - 150	-	++
Titane Titan Titanium	O / E	70 - 130	++	+
Aluminium	O / E	80 - 250	++	-
Cuivre Kupfer Copper	A / O / E	70 - 150	+	++
Laiton Messing Brass	A / O / E	80 - 200	++	-
Or - Argent Gold - Silber Gold - Silver	A / O / E	80 - 200	++	+

Avec revêtement, augmenter les valeurs de 20 %
Mit Beschichtung, Daten um 20 % erhöhen
With coating, increase data by 20 %

*O = huile de coupe / Schneidöl / cutting oil
*E = emulsion
*A = sec (air comprimé) / trocken (Druckluft) / dry (air)

** Avance conseillée pour des vitesses de rotation entre 20'000 et 30'000 tours/min
** Empfohlener Vorschub für Drehgeschwindigkeiten zwischen 20'000 und 30'000 U/Min
** Recommended feed rate for rotation speed between 20'000 and 30'000 RPM

Fraises à graver avec plat
Gravierfräser mit Fläche
Engraving mills with flat

2300-P

SWISS  MADE

MD
 VHM
 HM

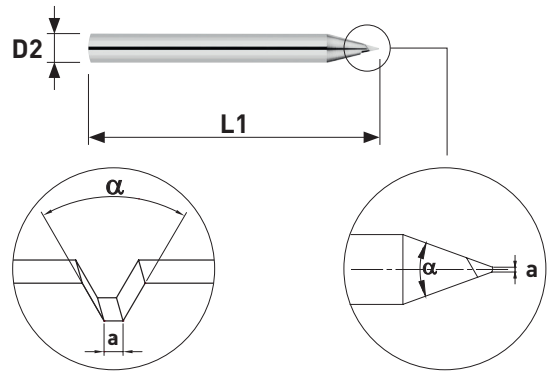

Art. N°	α	a	D2 h4	L1	N	TiAlN	TiCN	ALFA-TOP
2330-P-_a)	30°	0.02-0.10* / 0.10-0.30* ^{*1}	3.00	33	■	■	■	□
2335-P-_a)	35°	0.02-0.10* / 0.10-0.30* ^{*1}	3.00	33	■	■	■	□
2340-P-_a)	40°	0.02-0.10* / 0.10-0.30* ^{*1}	3.00	33	■	■	■	□
2345-P-_a)	45°	0.02-0.10* / 0.10-0.30* ^{*1}	3.00	33	■	■	■	□
2350-P-_a)	50°	0.02-0.10* / 0.10-0.30* ^{*1}	3.00	33	■	■	■	□
2355-P-_a)	55°	0.02-0.10* / 0.10-0.30* ^{*1}	3.00	33	■	■	■	□
2360-P-_a)	60°	0.02-0.10* / 0.10-0.30* ^{*1}	3.00	33	■	■	■	□
2365-P-_a)	65°	0.02-0.10* / 0.10-0.30* ^{*1}	3.00	33	■	■	■	□
2370-P-_a)	70°	0.02-0.10* / 0.10-0.30* ^{*1}	3.00	33	■	■	■	□
2390-P-_a)	90°	0.02-0.10* / 0.10-0.30* ^{*1}	3.00	33	■	■	■	□

* tous les 0.01 mm
 * alle 0.01 mm
 * every 0.01 mm

*1 tous les 0.05 mm
 *1 alle 0.05 mm
 *1 every 0.05 mm

Autres dimensions sur demande
 Andere Abmessungen auf Anfrage
 Other dimensions on request

■ = Disponible/Verfügbar/Available
 □ = Selon disponibilité du stock/Je nach Lagerverfügbarkeit/Depending on stock availability
 Autre revêtement sur demande/Andere Beschichtung auf Anfrage/Other coating on request

Fraises à graver à rayon
Gravierfräser mit Radius
Engraving mills with radius

2300-R

SWISS  MADE

MD
VHM
HM

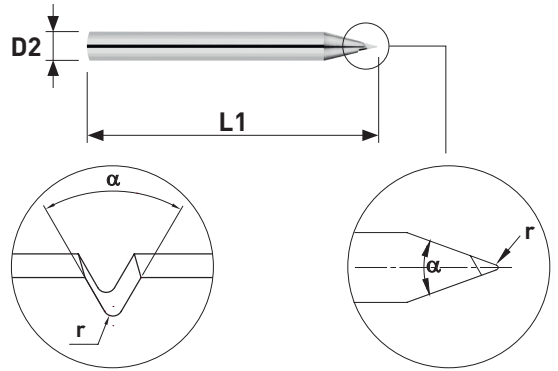

Art. N°	α	r	D2 h4	L1	N	TiAlN	TiCN	ALFA-TOP
2330-R-_(r)	30°	0.04-0.10* / 0.10-0.30* ^{*1}	3.00	33	■	■	■	□
2335-R-_(r)	35°	0.04-0.10* / 0.10-0.30* ^{*1}	3.00	33	■	■	■	□
2340-R-_(r)	40°	0.04-0.10* / 0.10-0.30* ^{*1}	3.00	33	■	■	■	□
2345-R-_(r)	45°	0.04-0.10* / 0.10-0.30* ^{*1}	3.00	33	■	■	■	□
2350-R-_(r)	50°	0.04-0.10* / 0.10-0.30* ^{*1}	3.00	33	■	■	■	□
2355-R-_(r)	55°	0.04-0.10* / 0.10-0.30* ^{*1}	3.00	33	■	■	■	□
2360-R-_(r)	60°	0.04-0.10* / 0.10-0.30* ^{*1}	3.00	33	■	■	■	□
2365-R-_(r)	65°	0.04-0.10* / 0.10-0.30* ^{*1}	3.00	33	■	■	■	□
2370-R-_(r)	70°	0.04-0.10* / 0.10-0.30* ^{*1}	3.00	33	■	■	■	□
2390-R-_(r)	90°	0.04-0.10* / 0.10-0.30* ^{*1}	3.00	33	■	■	■	□

* tous les 0.01 mm
* alle 0.01 mm
* every 0.01 mm

*1 tous les 0.05 mm
*1 alle 0.05 mm
*1 every 0.05 mm

Autres dimensions sur demande
Andere Abmessungen auf Anfrage
Other dimensions on request

Fraises à graver renforcées
Verstärkte Gravierfräser
Reinforced engraving mills

2900-P

SWISS  MADE

MD
VHM
HM

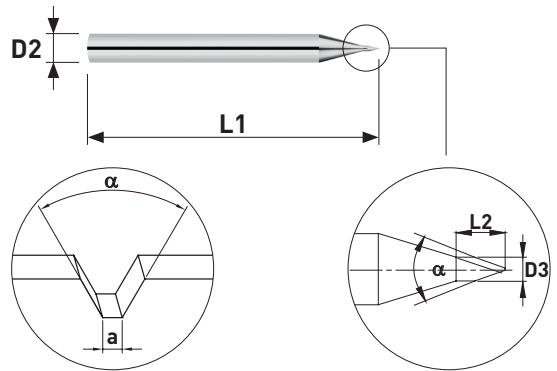

Art. N°	α	a	D3	L2	D2 h4	L1	N	TiAlN	TiCN	ALFA-TOP
2930-P-_(a)	30°	0.04-0.10* / 0.10-0.30* ^{*1}	0.60	1.80	3.00	33	■	■	■	□
2935-P-_(a)	35°	0.04-0.10* / 0.10-0.30* ^{*1}	0.60	1.80	3.00	33	■	■	■	□
2940-P-_(a)	40°	0.04-0.10* / 0.10-0.30* ^{*1}	0.60	1.80	3.00	33	■	■	■	□
2945-P-_(a)	45°	0.04-0.10* / 0.10-0.30* ^{*1}	0.60	1.80	3.00	33	■	■	■	□
2950-P-_(a)	50°	0.04-0.10* / 0.10-0.30* ^{*1}	1.00	2.00	3.00	33	■	■	■	□
2955-P-_(a)	55°	0.04-0.10* / 0.10-0.30* ^{*1}	1.00	2.00	3.00	33	■	■	■	□
2960-P-_(a)	60°	0.04-0.10* / 0.10-0.30* ^{*1}	1.20	2.00	3.00	33	■	■	■	□
2965-P-_(a)	65°	0.04-0.10* / 0.10-0.30* ^{*1}	1.20	2.00	3.00	33	■	■	■	□
2970-P-_(a)	70°	0.04-0.10* / 0.10-0.30* ^{*1}	1.20	2.00	3.00	33	■	■	■	□
2990-P-_(a)	90°	0.04-0.10* / 0.10-0.30* ^{*1}	1.20	2.00	3.00	33	■	■	■	□

* tous les 0.01 mm
 * alle 0.01 mm
 * every 0.01 mm



*1 tous les 0.05 mm
 *1 alle 0.05 mm
 *1 every 0.05 mm

Autres dimensions sur demande
 Andere Abmessungen auf Anfrage
 Other dimensions on request

■ = Disponible / Verfügbar / Available
 □ = Selon disponibilité du stock / Je nach Lagerverfügbarkeit / Depending on stock availability
 Autre revêtement sur demande / Andere Beschichtung auf Anfrage / Other coating on request

3000



Rubrique	Type	Corps	Angle	Diamètre	Page	
Rubrik	Typ	Schaft	Winkel	Durchmesser	Seite	
Section	Type	Shank	Angle	Diameter	Page	
Paramètres						
Schnittwerte					2.02-2.03	
Data						
Forets à centrer NC NC-Zentrierbohrer NC centering drills	MD 	3680-60	Ø2 - Ø6	60°	Ø2.00 - 6.00	2.04
	VHM	3680-90	Ø2 - Ø6	90°	Ø0.50 - 6.00	2.05
	HM	3680-120	Ø2 - Ø6	120°	Ø0.50 - 6.00	2.06
		3690	Ø2 - Ø3	90°	Ø0.50 - 3.00	2.07
Forets Bohrer Drills	MD VHM HM	3010	D = D	120°	Ø0.50 - 6.00	2.08
		3011	Ø2	120°	Ø0.80 - 2.00	2.09
		3012	Ø1.50 - Ø2.50	120°	Ø0.50 - 2.40	2.10
		3013	Ø1.00 - Ø2.00	120°	Ø0.40 - 1.90	2.11
		3014	Ø1.50 - Ø2.00	120°	Ø0.50 - 1.95	2.12
		3020	Ø3	130°	Ø0.10 - 2.00	2.13 - 2.15
		3023	Ø3	130°	Ø0.10 - 3.00	2.16 - 2.19
		3026	Ø3	130°	Ø0.20 - 2.00	2.20 - 2.22
3030 (Z3)	Ø3	140°	Ø0.20 - 2.99	2.23 - 2.25		

Matière Werkstoff Material	Lubrifiant* Kühlung* Coolant*	Vc [m/min]	Non revêtu Unbeschichtet Uncoated	Revêtu Beschichtet Coated
Acier inoxydable Rostfreier Stahl Stainless steel	O / E	40 - 60	+	++
Acier Stahl <700 N/mm ² Steel	O / E	60 - 100	+	++
Acier Stahl >700 N/mm ² Steel	O / E	40 - 70	+	++
Titane Titan Titanium	O / E	30 - 60	++	-
Aluminium	O / E	80 - 150	++	-
Cuivre Kupfer Copper	A / O / E	60 - 90	+	++
Laiton Messing Brass	A / O / E	70 - 100	++	-
Or - Argent Gold - Silber Gold - Silver	A / O / E	60 - 100	++	-

Avec revêtement, augmenter les valeurs de 20 %
Mit Beschichtung, Daten um 20 % erhöhen
With coating, increase data by 20 %

***O = huile de coupe / Schneidöl / cutting oil**
***E = emulsion**
***A = sec (air comprimé) / trocken (Druckluft) / dry (air)**

Paramètres de coupe indicatifs
Empfohlene Schnittwerte
Standard machining data

Forets
Bohrer
Drills

Matière Werkstoff Material	Lubrifiant* Kühlung* Coolant*	Vc [m/min]	f [mm/U] Ø 0.4 - 0.6	f [mm/U] Ø 0.6 - 1.0	f [mm/U] Ø 1.0 - 3.0	f [mm/U] Ø 3.0 - 6.0
Acier inoxydable Rostfreier Stahl Stainless steel	O / E	30 - 60	0.003 - 0.006	0.005 - 0.012	0.010 - 0.040	0.040 - 0.080
Acier Stahl <700 N/mm ² Steel	O / E	60 - 100	0.004 - 0.008	0.006 - 0.015	0.010 - 0.040	0.040 - 0.100
Acier Stahl >700 N/mm ² Steel	O / E	30 - 60	0.003 - 0.005	0.005 - 0.012	0.010 - 0.040	0.040 - 0.080
Titane Titan Titanium	O / E	25 - 50	0.002 - 0.005	0.004 - 0.010	0.008 - 0.030	0.030 - 0.070
Aluminium	O / E	60 - 150	0.004 - 0.010	0.006 - 0.030	0.020 - 0.070	0.050 - 0.150
Cuivre Kupfer Copper	A / O / E	50 - 80	0.004 - 0.012	0.007 - 0.020	0.050 - 0.060	0.050 - 0.120
Laiton Messing Brass	A / O / E	60 - 100	0.005 - 0.015	0.008 - 0.030	0.020 - 0.070	0.060 - 0.150
Or - Argent Gold - Silber Gold - Silver	A / O / E	50 - 100	0.004 - 0.010	0.006 - 0.030	0.020 - 0.070	0.060 - 0.150

Avec revêtement, augmenter les valeurs de 20 %
Mit Beschichtung, Daten um 20 % erhöhen
With coating, increase data by 20 %

***O = huile de coupe / Schneidöl / cutting oil**
***E = emulsion**
***A = sec (air comprimé) / trocken (Druckluft) / dry (air)**

Forets à centre NC
 NC-Zentrierbohrer
 NC centering drills

3680-60

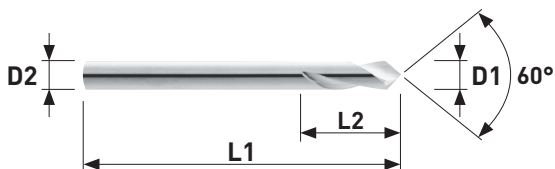

SWISS  MADE

MD	λ 25°	60°
VHM		
HM		



Art. N°	D1 h6	L2	D2 h6	L1	N	TiAlN
3680-2.00-60	2.00	8.00	2.00	39	■	■
3680-3.00-60	3.00	10.00	3.00	39	■	■
3680-4.00-60	4.00	12.00	4.00	50	■	■
3680-5.00-60	5.00	14.00	5.00	50	■	■
3680-6.00-60	6.00	16.00	6.00	50	■	■



Forets à centre NC
NC-Zentrierbohrer
NC centering drills

3680-90

SWISS  MADE

MD
VHM
HM

λ 25°

90°

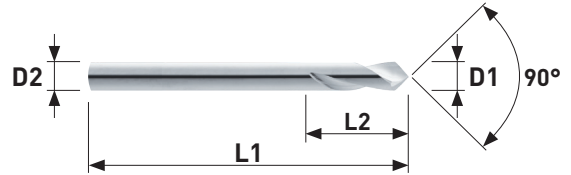

Art. N°	D1 h6	L2	D2 h6	L1	N	TiAlN
3680-0.50-90	0.50	1.50	2.00	39	■	
3680-0.60-90	0.60	1.50	2.00	39	■	
3680-0.70-90	0.70	1.50	2.00	39	■	
3680-0.80-90	0.80	1.50	2.00	39	■	
3680-0.90-90	0.90	1.50	2.00	39	■	
3680-1.00-90	1.00	3.00	2.00	39	■	
3680-1.10-90	1.10	3.00	2.00	39	■	
3680-1.20-90	1.20	3.00	2.00	39	■	
3680-1.30-90	1.30	3.00	2.00	39	■	
3680-1.40-90	1.40	3.00	2.00	39	■	
3680-1.50-90	1.50	4.00	2.00	39	■	
3680-1.60-90	1.60	4.00	2.00	39	■	
3680-1.70-90	1.70	4.00	2.00	39	■	
3680-1.80-90	1.80	4.00	2.00	39	■	
3680-1.90-90	1.90	4.00	2.00	39	■	
3680-2.00-90	2.00	8.00	2.00	39	■	■
3680-2.50-90	2.50	8.00	2.50	39	■	■
3680-3.00-90	3.00	10.00	3.00	39	■	■
3680-4.00-90	4.00	12.00	4.00	50	■	■
3680-5.00-90	5.00	15.00	5.00	50	■	■
3680-6.00-90	6.00	16.00	6.00	57	■	■

Forets à centre NC
NC-Zentrierbohrer
NC centering drills

3680-120

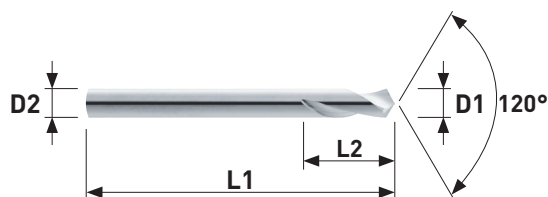

SWISS  MADE

MD	λ 25°	120°
VHM		
HM		

Art. N°	D1 h6	L2	D2 h6	L1	N	TiAlN
3680-0.50-120	0.50	1.50	2.00	39	■	
3680-0.60-120	0.60	1.50	2.00	39	■	
3680-0.70-120	0.70	1.50	2.00	39	■	
3680-0.80-120	0.80	1.50	2.00	39	■	
3680-0.90-120	0.90	1.50	2.00	39	■	
3680-1.00-120	1.00	3.00	2.00	39	■	
3680-1.10-120	1.10	3.00	2.00	39	■	
3680-1.20-120	1.20	3.00	2.00	39	■	
3680-1.30-120	1.30	3.00	2.00	39	■	
3680-1.40-120	1.40	3.00	2.00	39	■	
3680-1.50-120	1.50	4.00	2.00	39	■	
3680-1.60-120	1.60	4.00	2.00	39	■	
3680-1.70-120	1.70	4.00	2.00	39	■	
3680-1.80-120	1.80	4.00	2.00	39	■	
3680-1.90-120	1.90	4.00	2.00	39	■	
3680-2.00-120	2.00	8.00	2.00	39	■	■
3680-2.50-120	2.50	8.00	2.50	39	■	■
3680-3.00-120	3.00	10.00	3.00	39	■	■
3680-4.00-120	4.00	12.00	4.00	50	■	■
3680-5.00-120	5.00	15.00	5.00	50	■	■
3680-6.00-120	6.00	16.00	6.00	57	■	■

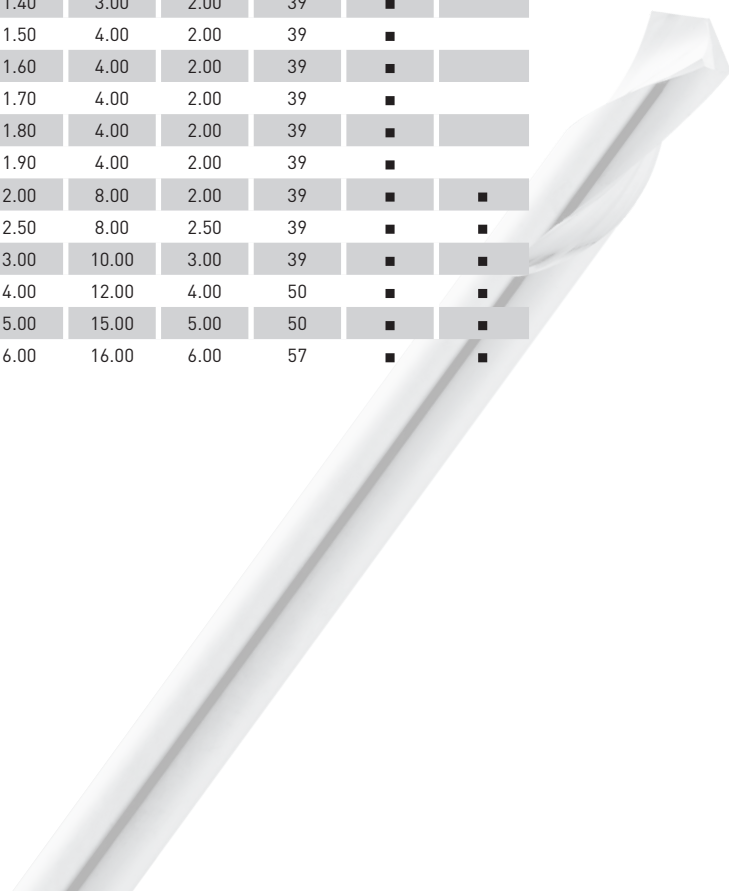

Forets à centre haute précision NC
NC-Zentrierbohrer hohe Präzision 3690
NC centering drills high precision

SWISS  MADE

MD			
VHM	λ 25°	λ 32°	90°
HM			

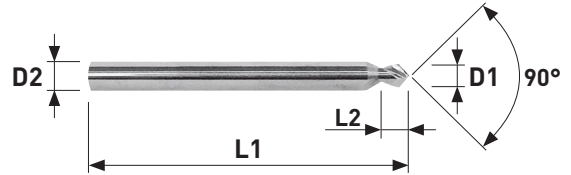

Art. N°	D1 h6	L2	D2 h6	L1	N	TiAlN
3690-0.50	0.50	2.50	2.00	39	■	
3690-0.60	0.60	2.50	2.00	39	■	
3690-0.70	0.70	2.50	2.00	39	■	
3690-0.80	0.80	2.50	2.00	39	■	
3690-0.90	0.90	2.50	2.00	39	■	
3690-1.00	1.00	3.00	2.00	39	■	
3690-1.10	1.10	3.00	2.00	39	■	
3690-1.20	1.20	3.00	2.00	39	■	
3690-1.30	1.30	3.00	2.00	39	■	
3690-1.40	1.40	3.00	2.00	39	■	
3690-1.50	1.50	3.50	2.00	39	■	
3690-1.60	1.60	3.50	2.00	39	■	
3690-1.70	1.70	3.50	2.00	39	■	
3690-1.80	1.80	3.50	2.00	39	■	
3690-1.90	1.90	3.50	2.00	39	■	
3690-2.00	2.00	-	2.00	39	■	■
3690-2.10	2.10	4.00	3.00	39	■	■
3690-2.20	2.20	4.00	3.00	39	■	■
3690-2.30	2.30	4.00	3.00	39	■	■
3690-2.40	2.40	4.00	3.00	39	■	■
3690-2.50	2.50	4.00	3.00	39	■	■
3690-2.60	2.60	4.00	3.00	39	■	■
3690-2.70	2.70	4.00	3.00	39	■	■
3690-2.80	2.80	4.00	3.00	39	■	■
3690-2.90	2.90	4.00	3.00	39	■	■
3690-3.00	3.00	-	3.00	50	■	■

Forets Bohrer Drills

3010

SWISS  MADE

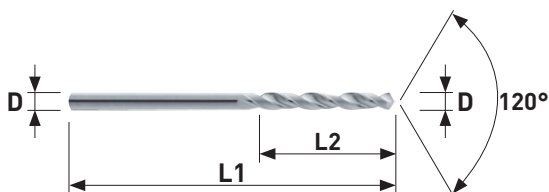
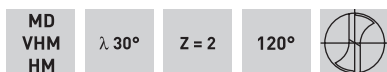

Art N°	D h6	L2	L1	N
3010-0.50	0.50	5.00	30	■
3010-0.55	0.55	5.00	30	■
3010-0.60	0.60	5.00	30	■
3010-0.65	0.65	6.00	30	■
3010-0.70	0.70	6.00	30	■
3010-0.75	0.75	8.00	30	■
3010-0.80	0.80	8.00	30	■
3010-0.85	0.85	9.00	30	■
3010-0.90	0.90	9.00	30	■
3010-0.95	0.95	10.00	30	■
3010-1.00	1.00	10.00	30	■
3010-1.05	1.05	10.00	30	■
3010-1.10	1.10	10.00	30	■
3010-1.15	1.15	12.00	30	■
3010-1.20	1.20	12.00	30	■
3010-1.25	1.25	12.00	30	■
3010-1.30	1.30	12.00	30	■
3010-1.35	1.35	12.00	30	■
3010-1.40	1.40	12.00	30	■
3010-1.45	1.45	12.00	30	■
3010-1.50	1.50	12.00	30	■
3010-1.55	1.55	16.00	40	■
3010-1.60	1.60	16.00	40	■
3010-1.65	1.65	16.00	40	■
3010-1.70	1.70	16.00	40	■
3010-1.75	1.75	16.00	40	■
3010-1.80	1.80	16.00	40	■
3010-1.85	1.85	16.00	40	■
3010-1.90	1.90	16.00	40	■
3010-1.95	1.95	16.00	40	■
3010-2.00	2.00	16.00	40	■
3010-2.05	2.05	18.00	40	■
3010-2.10	2.10	18.00	40	■
3010-2.15	2.15	18.00	40	■
3010-2.20	2.20	18.00	40	■
3010-2.25	2.25	18.00	40	■
3010-2.30	2.30	18.00	40	■
3010-2.35	2.35	18.00	40	■
3010-2.40	2.40	18.00	40	■
3010-2.45	2.45	18.00	40	■
3010-2.50	2.50	18.00	40	■

Art N°	D h6	L2	L1	N
3010-2.55	2.55	18.00	45	■
3010-2.60	2.60	18.00	45	■
3010-2.65	2.65	18.00	45	■
3010-2.70	2.70	18.00	45	■
3010-2.75	2.75	18.00	45	■
3010-2.80	2.80	18.00	45	■
3010-2.85	2.85	18.00	45	■
3010-2.90	2.90	18.00	45	■
3010-2.95	2.95	18.00	45	■
3010-3.00	3.00	18.00	45	■
3010-3.10	3.10	20.00	50	■
3010-3.20	3.20	20.00	50	■
3010-3.30	3.30	20.00	50	■
3010-3.40	3.40	20.00	50	■
3010-3.50	3.50	20.00	50	■
3010-3.60	3.60	20.00	50	■
3010-3.70	3.70	20.00	50	■
3010-3.80	3.80	20.00	50	■
3010-3.90	3.90	20.00	50	■
3010-4.00	4.00	20.00	50	■
3010-4.10	4.10	25.00	50	■
3010-4.20	4.20	25.00	50	■
3010-4.30	4.30	25.00	50	■
3010-4.40	4.40	25.00	50	■
3010-4.50	4.50	25.00	50	■
3010-4.60	4.60	25.00	50	■
3010-4.70	4.70	25.00	50	■
3010-4.80	4.80	25.00	50	■
3010-4.90	4.90	25.00	50	■
3010-5.00	5.00	25.00	50	■
3010-5.10	5.10	25.00	50	■
3010-5.20	5.20	25.00	50	■
3010-5.30	5.30	25.00	50	■
3010-5.40	5.40	25.00	50	■
3010-5.50	5.50	25.00	50	■
3010-5.60	5.60	25.00	50	■
3010-5.70	5.70	25.00	50	■
3010-5.80	5.80	25.00	50	■
3010-5.90	5.90	25.00	50	■
3010-6.00	6.00	25.00	50	■

**Forets
Bohrer
Drills**

3011

SWISS  MADE

MD VHM HM	λ 35°	Z = 2	120°	
-----------------	---------------	-------	------	---

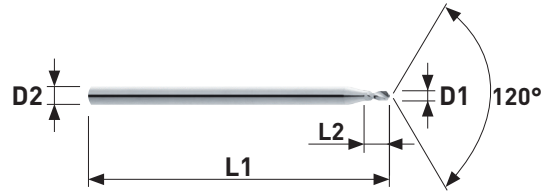

Art N°	D1 h6	L2	D2 h6	L1	N
3011-0.80	0.80	2.00	2.00	30	■
3011-0.90	0.90	2.00	2.00	30	■
3011-1.00	1.00	2.00	2.00	30	■
3011-1.10	1.10	2.00	2.00	30	■
3011-1.20	1.20	2.50	2.00	30	■
3011-1.30	1.30	2.50	2.00	30	■
3011-1.40	1.40	2.50	2.00	30	■
3011-1.50	1.50	4.00	2.00	30	■
3011-2.00	2.00	5.00	2.00	30	■



**Forets
Bohrer
Drills**

3012

SWISS  MADE

MD VHM HM	λ 24°	Z = 2	120°	
-----------------	---------------	-------	------	---

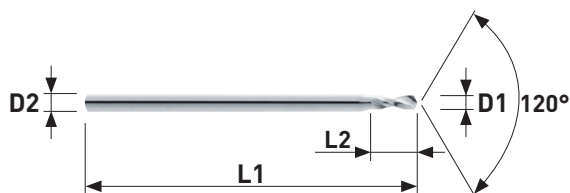

Art. N°	D1 h6	L2	D2 h6	L1	N
3012-0.50	0.50	1.70	1.50	30	■
3012-0.55	0.55	1.90	1.50	30	■
3012-0.60	0.60	1.90	1.50	30	■
3012-0.65	0.65	1.90	1.50	30	■
3012-0.70	0.70	2.40	1.50	30	■
3012-0.75	0.75	2.40	1.50	30	■
3012-0.80	0.80	2.60	1.50	30	■
3012-0.85	0.85	2.60	1.50	30	■
3012-0.90	0.90	3.00	1.50	30	■
3012-0.95	0.95	3.00	1.50	30	■
3012-1.00	1.00	3.40	1.50	30	■
3012-1.10	1.10	3.80	1.50	30	■
3012-1.20	1.20	4.20	1.50	30	■
3012-1.30	1.30	4.20	1.50	30	■
3012-1.40	1.40	4.70	1.50	30	■
3012-1.50	1.50	4.70	2.00	38	■
3012-1.60	1.60	5.40	2.00	38	■
3012-1.70	1.70	5.40	2.00	38	■
3012-1.80	1.80	6.50	2.00	38	■
3012-1.90	1.90	6.50	2.00	38	■
3012-2.00	2.00	6.50	2.50	38	■
3012-2.10	2.10	6.50	2.50	38	■
3012-2.20	2.20	6.50	2.50	38	■
3012-2.30	2.30	6.50	2.50	38	■
3012-2.40	2.40	6.50	2.50	38	■

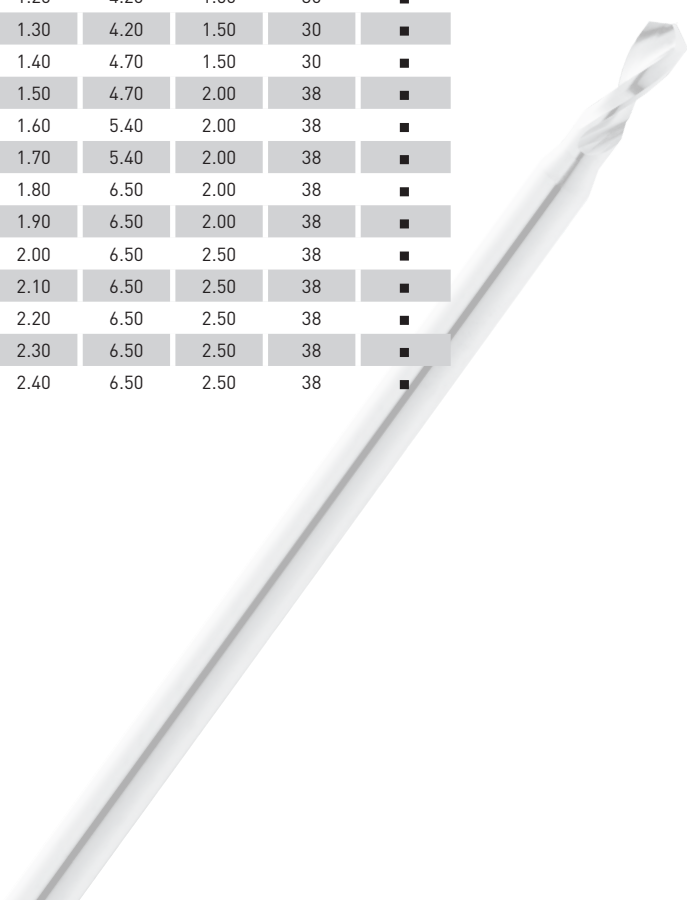

**Forets
Bohrer
Drills**

3013

SWISS  MADE

MD VHM HM	λ 35°	Z = 2	120°	
-----------------	---------------	-------	------	---

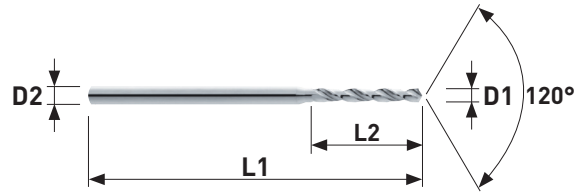

Art. N°	D1 h6	L2	D2 h6	L1	N
3013-0.40	0.40	3.60	1.00	25	■
3013-0.45	0.45	3.60	1.00	25	■
3013-0.50	0.50	4.00	1.00	25	■
3013-0.55	0.55	4.50	1.00	25	■
3013-0.60	0.60	4.50	1.00	25	■
3013-0.65	0.65	5.00	1.00	25	■
3013-0.70	0.70	5.60	1.00	25	■
3013-0.75	0.75	5.60	1.00	25	■
3013-0.80	0.80	6.30	1.50	30	■
3013-0.85	0.85	6.30	1.50	30	■
3013-0.90	0.90	7.10	1.50	30	■
3013-0.95	0.95	7.10	1.50	30	■
3013-1.00	1.00	8.00	1.50	30	■
3013-1.05	1.05	8.00	1.50	30	■
3013-1.10	1.10	9.00	1.50	30	■
3013-1.15	1.15	9.00	1.50	30	■
3013-1.20	1.20	10.00	1.50	30	■
3013-1.25	1.25	10.00	1.50	30	■
3013-1.30	1.30	10.00	1.50	30	■
3013-1.35	1.35	11.20	1.50	30	■
3013-1.40	1.40	11.20	1.50	30	■
3013-1.45	1.45	11.20	1.50	30	■
3013-1.50	1.50	12.00	2.00	38	■
3013-1.60	1.60	12.00	2.00	38	■
3013-1.70	1.70	12.00	2.00	38	■
3013-1.80	1.80	12.00	2.00	38	■
3013-1.90	1.90	12.00	2.00	38	■

Forets
Bohrer
Drills

3014

SWISS  MADE

MD VHM HM	λ 30°	Z = 2	120°	
-----------------	---------------	-------	------	---

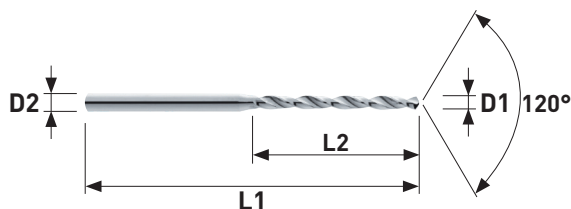

Art. N°	D1 h6	L2	D2 h6	L1	N
3014-0.50	0.50	6.00	1.50	30	■
3014-0.55	0.55	6.50	1.50	30	■
3014-0.60	0.60	6.50	1.50	30	■
3014-0.65	0.65	7.50	1.50	30	■
3014-0.70	0.70	8.50	1.50	30	■
3014-0.75	0.75	8.50	1.50	30	■
3014-0.80	0.80	9.50	1.50	30	■
3014-0.85	0.85	9.50	1.50	30	■
3014-0.90	0.90	10.50	1.50	30	■
3014-0.95	0.95	10.50	1.50	30	■
3014-1.00	1.00	12.00	1.50	38	■
3014-1.05	1.05	12.00	1.50	38	■
3014-1.10	1.10	13.50	1.50	38	■
3014-1.15	1.15	13.50	1.50	38	■
3014-1.20	1.20	15.00	1.50	38	■
3014-1.25	1.25	15.00	1.50	38	■
3014-1.30	1.30	17.00	1.50	38	■
3014-1.35	1.35	17.00	1.50	38	■
3014-1.40	1.40	17.00	1.50	38	■
3014-1.45	1.45	17.00	1.50	38	■
3014-1.50	1.50	18.00	2.00	38	■
3014-1.55	1.55	18.00	2.00	38	■
3014-1.60	1.60	18.00	2.00	38	■
3014-1.65	1.65	18.00	2.00	38	■
3014-1.70	1.70	18.00	2.00	38	■
3014-1.75	1.75	18.00	2.00	38	■
3014-1.80	1.80	18.00	2.00	38	■
3014-1.85	1.85	18.00	2.00	38	■
3014-1.90	1.90	18.00	2.00	38	■
3014-1.95	1.95	18.00	2.00	38	■

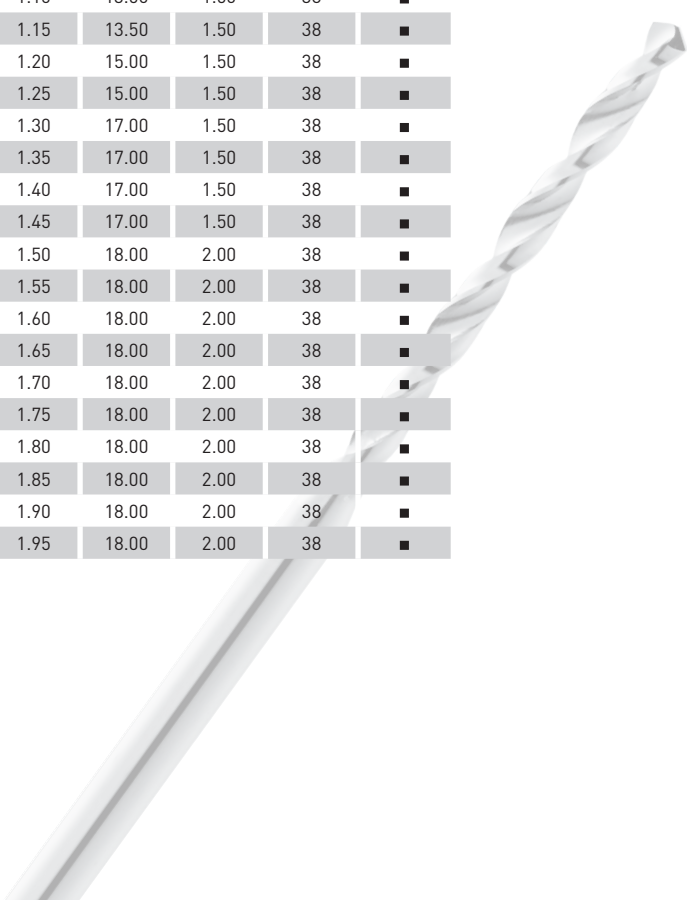

Forets Bohrer Drills

3020

SWISS  MADE

MD VHM HM	λ 30°	2xD1	130°	
-----------------	---------------	------	------	---

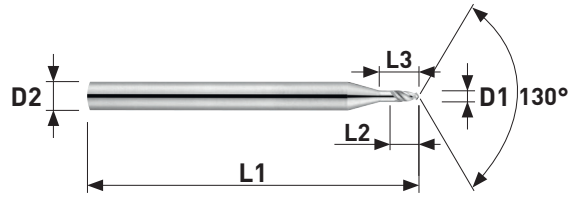

Art. N°	D1 0/+0.005	L2	L3	D2 h6	L1	N
3020-0.10	0.10	0.35	0.55	3.00	38	■
3020-0.11	0.11	0.35	0.55	3.00	38	■
3020-0.12	0.12	0.35	0.55	3.00	38	■
3020-0.13	0.13	0.40	0.60	3.00	38	■
3020-0.14	0.14	0.40	0.60	3.00	38	■
3020-0.15	0.15	0.40	0.60	3.00	38	■
3020-0.16	0.16	0.40	0.60	3.00	38	■
3020-0.17	0.17	0.50	0.70	3.00	38	■
3020-0.18	0.18	0.50	0.70	3.00	38	■
3020-0.19	0.19	0.50	0.70	3.00	38	■
3020-0.20	0.20	0.55	0.75	3.00	38	■
3020-0.21	0.21	0.55	0.75	3.00	38	■
3020-0.22	0.22	0.60	0.80	3.00	38	■
3020-0.23	0.23	0.60	0.80	3.00	38	■
3020-0.24	0.24	0.60	0.80	3.00	38	■
3020-0.25	0.25	0.70	0.90	3.00	38	■
3020-0.26	0.26	0.70	0.90	3.00	38	■
3020-0.27	0.27	0.70	0.90	3.00	38	■
3020-0.28	0.28	0.80	1.00	3.00	38	■
3020-0.29	0.29	0.80	1.00	3.00	38	■
3020-0.30	0.30	0.90	1.20	3.00	38	■
3020-0.31	0.31	0.90	1.20	3.00	38	■
3020-0.32	0.32	0.90	1.20	3.00	38	■
3020-0.33	0.33	0.90	1.20	3.00	38	■
3020-0.34	0.34	0.90	1.35	3.00	38	■
3020-0.35	0.35	0.90	1.35	3.00	38	■
3020-0.36	0.36	0.95	1.35	3.00	38	■
3020-0.37	0.37	0.95	1.35	3.00	38	■
3020-0.38	0.38	0.95	1.50	3.00	38	■
3020-0.39	0.39	0.95	1.50	3.00	38	■
3020-0.40	0.40	0.80	1.60	3.00	38	■
3020-0.41	0.41	0.82	1.60	3.00	38	■
3020-0.42	0.42	0.84	1.60	3.00	38	■
3020-0.43	0.43	0.86	1.60	3.00	38	■
3020-0.44	0.44	0.88	1.60	3.00	38	■
3020-0.45	0.45	0.90	1.60	3.00	38	■
3020-0.46	0.46	0.92	1.70	3.00	38	■
3020-0.47	0.47	0.94	1.70	3.00	38	■
3020-0.48	0.48	0.96	1.70	3.00	38	■
3020-0.49	0.49	0.98	1.70	3.00	38	■

Art. N°	D1 0/+0.005	L2	L3	D2 h6	L1	N
3020-0.50	0.50	1.00	1.70	3.00	38	■
3020-0.51	0.51	1.02	1.80	3.00	38	■
3020-0.52	0.52	1.04	1.80	3.00	38	■
3020-0.53	0.53	1.06	1.80	3.00	38	■
3020-0.54	0.54	1.08	1.80	3.00	38	■
3020-0.55	0.55	1.10	1.80	3.00	38	■
3020-0.56	0.56	1.12	1.90	3.00	38	■
3020-0.57	0.57	1.14	1.90	3.00	38	■
3020-0.58	0.58	1.16	1.90	3.00	38	■
3020-0.59	0.59	1.18	1.90	3.00	38	■
3020-0.60	0.60	1.20	1.90	3.00	38	■
3020-0.61	0.61	1.22	2.00	3.00	38	■
3020-0.62	0.62	1.24	2.00	3.00	38	■
3020-0.63	0.63	1.26	2.00	3.00	38	■
3020-0.64	0.64	1.28	2.00	3.00	38	■
3020-0.65	0.65	1.30	2.00	3.00	38	■
3020-0.66	0.66	1.32	2.10	3.00	38	■
3020-0.67	0.67	1.34	2.10	3.00	38	■
3020-0.68	0.68	1.36	2.10	3.00	38	■
3020-0.69	0.69	1.38	2.10	3.00	38	■
3020-0.70	0.70	1.40	2.10	3.00	38	■
3020-0.71	0.71	1.42	2.20	3.00	38	■
3020-0.72	0.72	1.44	2.20	3.00	38	■
3020-0.73	0.73	1.46	2.20	3.00	38	■
3020-0.74	0.74	1.48	2.20	3.00	38	■
3020-0.75	0.75	1.50	2.20	3.00	38	■
3020-0.76	0.76	1.52	2.30	3.00	38	■
3020-0.77	0.77	1.54	2.30	3.00	38	■
3020-0.78	0.78	1.56	2.30	3.00	38	■
3020-0.79	0.79	1.58	2.30	3.00	38	■
3020-0.80	0.80	1.60	2.30	3.00	38	■
3020-0.81	0.81	1.62	2.40	3.00	38	■
3020-0.82	0.82	1.64	2.40	3.00	38	■
3020-0.83	0.83	1.66	2.40	3.00	38	■
3020-0.84	0.84	1.68	2.40	3.00	38	■
3020-0.85	0.85	1.70	2.40	3.00	38	■
3020-0.86	0.86	1.72	2.50	3.00	38	■
3020-0.87	0.87	1.74	2.50	3.00	38	■
3020-0.88	0.88	1.76	2.50	3.00	38	■
3020-0.89	0.89	1.78	2.50	3.00	38	■

Forets Bohrer Drills

3020

SWISS  MADE

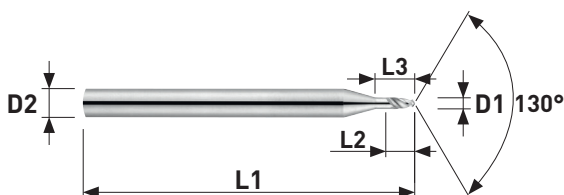

Art. N°	D1 0/+0.005	L2	L3	D2 h6	L1	N
3020-0.90	0.90	1.80	2.50	3.00	38	■
3020-0.91	0.91	1.82	2.60	3.00	38	■
3020-0.92	0.92	1.84	2.60	3.00	38	■
3020-0.93	0.93	1.86	2.60	3.00	38	■
3020-0.94	0.94	1.88	2.60	3.00	38	■
3020-0.95	0.95	1.90	2.60	3.00	38	■
3020-0.96	0.96	1.92	2.70	3.00	38	■
3020-0.97	0.97	1.94	2.70	3.00	38	■
3020-0.98	0.98	1.96	2.70	3.00	38	■
3020-0.99	0.99	1.98	2.70	3.00	38	■
3020-1.00	1.00	2.00	2.70	3.00	38	■
3020-1.01	1.01	2.02	3.50	3.00	38	■
3020-1.02	1.02	2.04	3.50	3.00	38	■
3020-1.03	1.03	2.06	3.50	3.00	38	■
3020-1.04	1.04	2.08	3.50	3.00	38	■
3020-1.05	1.05	2.10	3.50	3.00	38	■
3020-1.06	1.06	2.12	3.60	3.00	38	■
3020-1.07	1.07	2.14	3.60	3.00	38	■
3020-1.08	1.08	2.16	3.60	3.00	38	■
3020-1.09	1.09	2.18	3.60	3.00	38	■
3020-1.10	1.10	2.20	3.60	3.00	38	■
3020-1.11	1.11	2.22	3.70	3.00	38	■
3020-1.12	1.12	2.24	3.70	3.00	38	■
3020-1.13	1.13	2.26	3.70	3.00	38	■
3020-1.14	1.14	2.28	3.70	3.00	38	■
3020-1.15	1.15	2.30	3.70	3.00	38	■
3020-1.16	1.16	2.32	3.80	3.00	38	■
3020-1.17	1.17	2.34	3.80	3.00	38	■
3020-1.18	1.18	2.36	3.80	3.00	38	■
3020-1.19	1.19	2.38	3.80	3.00	38	■
3020-1.20	1.20	2.40	3.80	3.00	38	■
3020-1.21	1.21	2.42	4.20	3.00	38	■
3020-1.22	1.22	2.44	4.20	3.00	38	■
3020-1.23	1.23	2.46	4.20	3.00	38	■
3020-1.24	1.24	2.48	4.20	3.00	38	■
3020-1.25	1.25	2.50	4.20	3.00	38	■
3020-1.26	1.26	2.52	4.30	3.00	38	■
3020-1.27	1.27	2.54	4.30	3.00	38	■
3020-1.28	1.28	2.56	4.30	3.00	38	■
3020-1.29	1.29	2.58	4.30	3.00	38	■

Art. N°	D1 0/+0.005	L2	L3	D2 h6	L1	N
3020-1.30	1.30	2.60	4.30	3.00	38	■
3020-1.31	1.31	2.62	4.40	3.00	38	■
3020-1.32	1.32	2.64	4.40	3.00	38	■
3020-1.33	1.33	2.66	4.40	3.00	38	■
3020-1.34	1.34	2.68	4.40	3.00	38	■
3020-1.35	1.35	2.70	4.40	3.00	38	■
3020-1.36	1.36	2.72	4.50	3.00	38	■
3020-1.37	1.37	2.74	4.50	3.00	38	■
3020-1.38	1.38	2.76	4.50	3.00	38	■
3020-1.39	1.39	2.78	4.50	3.00	38	■
3020-1.40	1.40	2.80	4.50	3.00	38	■
3020-1.41	1.41	2.82	4.60	3.00	38	■
3020-1.42	1.42	2.84	4.60	3.00	38	■
3020-1.43	1.43	2.86	4.60	3.00	38	■
3020-1.44	1.44	2.88	4.60	3.00	38	■
3020-1.45	1.45	2.90	4.60	3.00	38	■
3020-1.46	1.46	2.92	4.70	3.00	38	■
3020-1.47	1.47	2.94	4.70	3.00	38	■
3020-1.48	1.48	2.96	4.70	3.00	38	■
3020-1.49	1.49	2.98	4.70	3.00	38	■
3020-1.50	1.50	3.00	4.70	3.00	38	■
3020-1.51	1.51	3.02	5.10	3.00	38	■
3020-1.52	1.52	3.04	5.10	3.00	38	■
3020-1.53	1.53	3.06	5.10	3.00	38	■
3020-1.54	1.54	3.08	5.10	3.00	38	■
3020-1.55	1.55	3.10	5.10	3.00	38	■
3020-1.56	1.56	3.12	5.20	3.00	38	■
3020-1.57	1.57	3.14	5.20	3.00	38	■
3020-1.58	1.58	3.16	5.20	3.00	38	■
3020-1.59	1.59	3.18	5.20	3.00	38	■
3020-1.60	1.60	3.20	5.20	3.00	38	■
3020-1.61	1.61	3.22	5.30	3.00	38	■
3020-1.62	1.62	3.24	5.30	3.00	38	■
3020-1.63	1.63	3.26	5.30	3.00	38	■
3020-1.64	1.64	3.28	5.30	3.00	38	■
3020-1.65	1.65	3.30	5.30	3.00	38	■
3020-1.66	1.66	3.32	5.40	3.00	38	■
3020-1.67	1.67	3.34	5.40	3.00	38	■
3020-1.68	1.68	3.36	5.40	3.00	38	■
3020-1.69	1.69	3.38	5.40	3.00	38	■

**Forets
Bohrer
Drills**

3020

SWISS  MADE

MD VHM HM	λ 30°	2xD1	130°	
-----------------	---------------	------	------	---

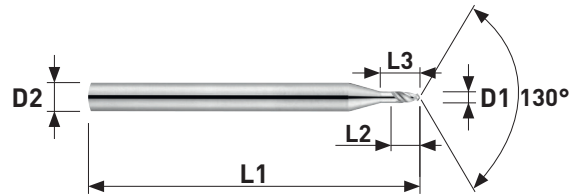

Art. N°	D1 0/+0.005	L2	L3	D2 h6	L1	N
3020-1.70	1.70	3.40	5.40	3.00	38	■
3020-1.71	1.71	3.42	5.50	3.00	38	■
3020-1.72	1.72	3.44	5.50	3.00	38	■
3020-1.73	1.73	3.46	5.50	3.00	38	■
3020-1.74	1.74	3.48	5.50	3.00	38	■
3020-1.75	1.75	3.50	5.50	3.00	38	■
3020-1.76	1.76	3.52	5.60	3.00	38	■
3020-1.77	1.77	3.54	5.60	3.00	38	■
3020-1.78	1.78	3.56	5.60	3.00	38	■
3020-1.79	1.79	3.58	5.60	3.00	38	■
3020-1.80	1.80	3.60	5.60	3.00	38	■
3020-1.81	1.81	3.62	5.70	3.00	38	■
3020-1.82	1.82	3.64	5.70	3.00	38	■
3020-1.83	1.83	3.66	5.70	3.00	38	■
3020-1.84	1.84	3.68	5.70	3.00	38	■
3020-1.85	1.85	3.70	5.70	3.00	38	■
3020-1.86	1.86	3.72	5.80	3.00	38	■
3020-1.87	1.87	3.74	5.80	3.00	38	■
3020-1.88	1.88	3.76	5.80	3.00	38	■
3020-1.89	1.89	3.78	5.80	3.00	38	■
3020-1.90	1.90	3.80	5.80	3.00	38	■
3020-1.91	1.91	3.82	5.90	3.00	38	■
3020-1.92	1.92	3.84	5.90	3.00	38	■
3020-1.93	1.93	3.86	5.90	3.00	38	■
3020-1.94	1.94	3.88	5.90	3.00	38	■
3020-1.95	1.95	3.90	5.90	3.00	38	■
3020-1.96	1.96	3.92	6.00	3.00	38	■
3020-1.97	1.97	3.94	6.00	3.00	38	■
3020-1.98	1.98	3.96	6.00	3.00	38	■
3020-1.99	1.99	3.98	6.00	3.00	38	■
3020-2.00	2.00	4.00	6.00	3.00	38	■

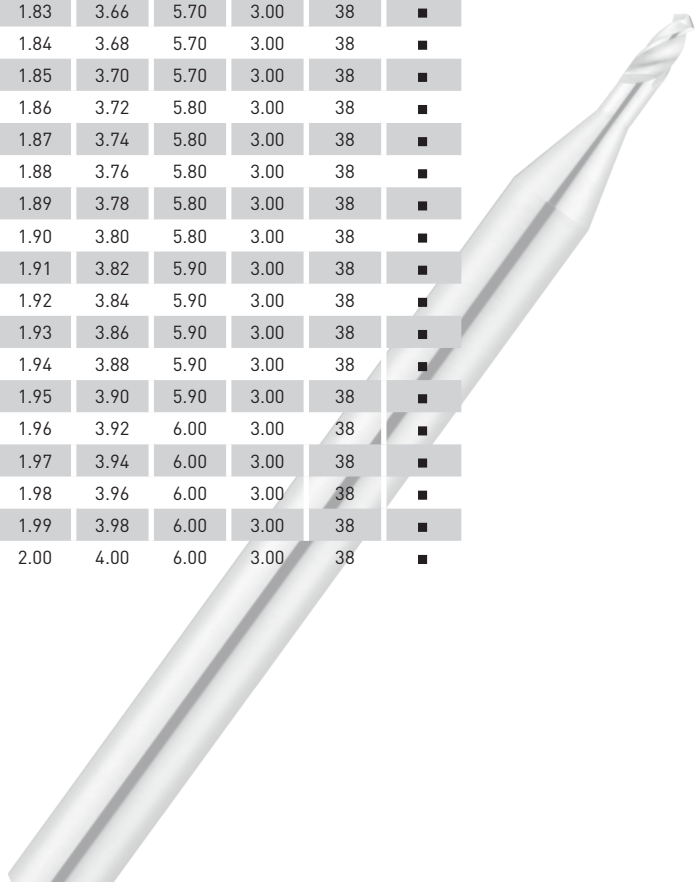

Forets Bohrer Drills

3023

SWISS  MADE

MD VHM HM	λ 35°	6xD1	Z = 2	130°	
-----------------	---------------	------	-------	------	---

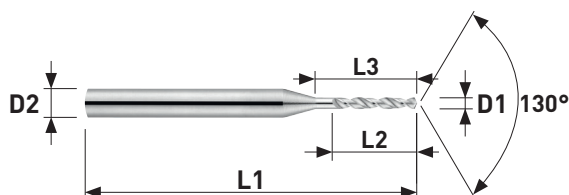

Art. N°	D1 0/-0.004	L2	L3	D2 h6	L1	N
3023-010	0.10	0.50	0.70	3.00	38	■
3023-011	0.11	0.50	0.70	3.00	38	■
3023-012	0.12	0.50	0.70	3.00	38	■
3023-013	0.13	0.80	1.00	3.00	38	■
3023-014	0.14	0.80	1.00	3.00	38	■
3023-015	0.15	0.80	1.00	3.00	38	■
3023-016	0.16	1.10	1.40	3.00	38	■
3023-017	0.17	1.10	1.40	3.00	38	■
3023-018	0.18	1.10	1.40	3.00	38	■
3023-019	0.19	1.10	1.40	3.00	38	■
3023-020	0.20	1.50	1.80	3.00	38	■
3023-021	0.21	1.50	1.80	3.00	38	■
3023-022	0.22	1.50	1.80	3.00	38	■
3023-023	0.23	1.50	1.80	3.00	38	■
3023-024	0.24	1.50	1.80	3.00	38	■
3023-025	0.25	1.90	2.20	3.00	38	■
3023-026	0.26	1.90	2.20	3.00	38	■
3023-027	0.27	1.90	2.20	3.00	38	■
3023-028	0.28	1.90	2.20	3.00	38	■
3023-029	0.29	1.90	2.20	3.00	38	■
3023-030	0.30	1.80	2.40	3.00	38	■
3023-031	0.31	1.80	2.40	3.00	38	■
3023-032	0.32	1.80	2.40	3.00	38	■
3023-033	0.33	1.80	2.40	3.00	38	■
3023-034	0.34	1.80	2.40	3.00	38	■
3023-035	0.35	2.20	2.80	3.00	38	■
3023-036	0.36	2.20	2.80	3.00	38	■
3023-037	0.37	2.20	2.80	3.00	38	■
3023-038	0.38	2.20	2.80	3.00	38	■
3023-039	0.39	2.70	3.60	3.00	38	■
3023-040	0.40	2.70	3.60	3.00	38	■
3023-041	0.41	2.70	3.60	3.00	38	■
3023-042	0.42	2.70	3.60	3.00	38	■
3023-043	0.43	2.70	3.60	3.00	38	■
3023-044	0.44	2.70	3.60	3.00	38	■
3023-045	0.45	2.70	3.60	3.00	38	■
3023-046	0.46	2.70	3.60	3.00	38	■
3023-047	0.47	2.70	3.60	3.00	38	■
3023-048	0.48	2.70	3.60	3.00	38	■
3023-049	0.49	3.20	4.00	3.00	38	■

Art. N°	D1 0/-0.004	L2	L3	D2 h6	L1	N
3023-050	0.50	3.20	4.00	3.00	38	■
3023-051	0.51	3.20	4.00	3.00	38	■
3023-052	0.52	3.20	4.00	3.00	38	■
3023-053	0.53	3.20	4.00	3.00	38	■
3023-054	0.54	3.60	4.50	3.00	38	■
3023-055	0.55	3.60	4.50	3.00	38	■
3023-056	0.56	3.60	4.50	3.00	38	■
3023-057	0.57	3.60	4.50	3.00	38	■
3023-058	0.58	3.60	4.50	3.00	38	■
3023-059	0.59	3.60	4.50	3.00	38	■
3023-060	0.60	3.60	4.50	3.00	38	■
3023-061	0.61	3.90	5.00	3.00	38	■
3023-062	0.62	3.90	5.00	3.00	38	■
3023-063	0.63	3.90	5.00	3.00	38	■
3023-064	0.64	3.90	5.00	3.00	38	■
3023-065	0.65	3.90	5.00	3.00	38	■
3023-066	0.66	3.90	5.00	3.00	38	■
3023-067	0.67	3.90	5.00	3.00	38	■
3023-068	0.68	4.50	5.60	3.00	38	■
3023-069	0.69	4.50	5.60	3.00	38	■
3023-070	0.70	4.50	5.60	3.00	38	■
3023-071	0.71	4.50	5.60	3.00	38	■
3023-072	0.72	4.50	5.60	3.00	38	■
3023-073	0.73	4.50	5.60	3.00	38	■
3023-074	0.74	4.50	5.60	3.00	38	■
3023-075	0.75	4.50	5.60	3.00	38	■
3023-076	0.76	5.00	6.30	3.00	38	■
3023-077	0.77	5.00	6.30	3.00	38	■
3023-078	0.78	5.00	6.30	3.00	38	■
3023-079	0.79	5.00	6.30	3.00	38	■
3023-080	0.80	5.00	6.30	3.00	38	■
3023-081	0.81	5.00	6.30	3.00	38	■
3023-082	0.82	5.00	6.30	3.00	38	■
3023-083	0.83	5.00	6.30	3.00	38	■
3023-084	0.84	5.00	6.30	3.00	38	■
3023-085	0.85	5.00	6.30	3.00	38	■
3023-086	0.86	5.70	7.10	3.00	38	■
3023-087	0.87	5.70	7.10	3.00	38	■
3023-088	0.88	5.70	7.10	3.00	38	■
3023-089	0.89	5.70	7.10	3.00	38	■

Forets Bohrer Drills

3023

SWISS  MADE

MD VHM HM	λ 35°	6xD1	Z = 2	130°	
-----------------	---------------	------	-------	------	---

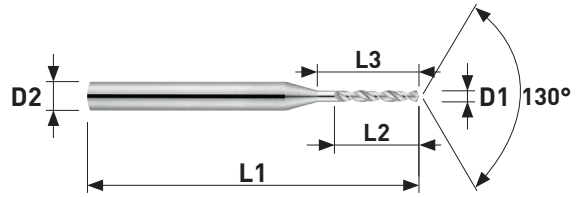

Art. N°	D1 0/-0.004	L2	L3	D2 h6	L1	N
3023-0.90	0.90	5.70	7.10	3.00	38	■
3023-0.91	0.91	5.70	7.10	3.00	38	■
3023-0.92	0.92	5.70	7.10	3.00	38	■
3023-0.93	0.93	5.70	7.10	3.00	38	■
3023-0.94	0.94	5.70	7.10	3.00	38	■
3023-0.95	0.95	5.70	7.10	3.00	38	■
3023-0.96	0.96	6.50	8.00	3.00	38	■
3023-0.97	0.97	6.50	8.00	3.00	38	■
3023-0.98	0.98	6.50	8.00	3.00	38	■
3023-0.99	0.99	6.50	8.00	3.00	38	■
3023-1.00	1.00	6.50	8.00	3.00	38	■
3023-1.01	1.01	6.50	8.00	3.00	38	■
3023-1.02	1.02	6.50	8.00	3.00	38	■
3023-1.03	1.03	6.50	8.00	3.00	38	■
3023-1.04	1.04	6.50	8.00	3.00	38	■
3023-1.05	1.05	6.50	8.00	3.00	38	■
3023-1.06	1.06	7.30	9.00	3.00	38	■
3023-1.07	1.07	7.30	9.00	3.00	38	■
3023-1.08	1.08	7.30	9.00	3.00	38	■
3023-1.09	1.09	7.30	9.00	3.00	38	■
3023-1.10	1.10	7.30	9.00	3.00	38	■
3023-1.11	1.11	7.30	9.00	3.00	38	■
3023-1.12	1.12	7.30	9.00	3.00	38	■
3023-1.13	1.13	7.30	9.00	3.00	38	■
3023-1.14	1.14	7.30	9.00	3.00	38	■
3023-1.15	1.15	7.30	9.00	3.00	38	■
3023-1.16	1.16	8.20	10.00	3.00	38	■
3023-1.17	1.17	8.20	10.00	3.00	38	■
3023-1.18	1.18	8.20	10.00	3.00	38	■
3023-1.19	1.19	8.20	10.00	3.00	38	■
3023-1.20	1.20	8.20	10.00	3.00	38	■
3023-1.21	1.21	8.20	10.00	3.00	38	■
3023-1.22	1.22	8.20	10.00	3.00	38	■
3023-1.23	1.23	8.20	10.00	3.00	38	■
3023-1.24	1.24	8.20	10.00	3.00	38	■
3023-1.25	1.25	8.20	10.00	3.00	38	■
3023-1.26	1.26	8.20	10.00	3.00	38	■
3023-1.27	1.27	8.20	10.00	3.00	38	■
3023-1.28	1.28	8.20	10.00	3.00	38	■
3023-1.29	1.29	8.20	10.00	3.00	38	■

Art. N°	D1 0/-0.004	L2	L3	D2 h6	L1	N
3023-1.30	1.30	8.20	10.00	3.00	38	■
3023-1.31	1.31	9.20	11.20	3.00	38	■
3023-1.32	1.32	9.20	11.20	3.00	38	■
3023-1.33	1.33	9.20	11.20	3.00	38	■
3023-1.34	1.34	9.20	11.20	3.00	38	■
3023-1.35	1.35	9.20	11.20	3.00	38	■
3023-1.36	1.36	9.20	11.20	3.00	38	■
3023-1.37	1.37	9.20	11.20	3.00	38	■
3023-1.38	1.38	9.20	11.20	3.00	38	■
3023-1.39	1.39	9.20	11.20	3.00	38	■
3023-1.40	1.40	9.20	11.20	3.00	38	■
3023-1.41	1.41	9.20	11.20	3.00	38	■
3023-1.42	1.42	9.20	11.20	3.00	38	■
3023-1.43	1.43	9.20	11.20	3.00	38	■
3023-1.44	1.44	9.20	11.20	3.00	38	■
3023-1.45	1.45	9.20	11.20	3.00	38	■
3023-1.46	1.46	9.20	11.20	3.00	38	■
3023-1.47	1.47	9.20	11.20	3.00	38	■
3023-1.48	1.48	9.20	11.20	3.00	38	■
3023-1.49	1.49	9.20	11.20	3.00	38	■
3023-1.50	1.50	9.20	11.20	3.00	38	■
3023-1.51	1.51	11.20	13.40	3.00	38	■
3023-1.52	1.52	11.20	13.40	3.00	38	■
3023-1.53	1.53	11.20	13.40	3.00	38	■
3023-1.54	1.54	11.20	13.40	3.00	38	■
3023-1.55	1.55	11.20	13.40	3.00	38	■
3023-1.56	1.56	11.20	13.40	3.00	38	■
3023-1.57	1.57	11.20	13.40	3.00	38	■
3023-1.58	1.58	11.20	13.40	3.00	38	■
3023-1.59	1.59	11.20	13.40	3.00	38	■
3023-1.60	1.60	11.20	13.40	3.00	38	■
3023-1.61	1.61	11.20	13.40	3.00	38	■
3023-1.62	1.62	11.20	13.40	3.00	38	■
3023-1.63	1.63	11.20	13.40	3.00	38	■
3023-1.64	1.64	11.20	13.40	3.00	38	■
3023-1.65	1.65	11.20	13.40	3.00	38	■
3023-1.66	1.66	11.20	13.40	3.00	38	■
3023-1.67	1.67	11.20	13.40	3.00	38	■
3023-1.68	1.68	11.20	13.40	3.00	38	■
3023-1.69	1.69	11.20	13.40	3.00	38	■

■ = Disponible/Verfügbar/Available
 Revêtement sur demande/Beschichtung auf Anfrage/Coating on request

Forets Bohrer Drills

3023

SWISS  MADE

MD VHM HM	λ 35°	6xD1	Z = 2	130°	
-----------------	---------------	------	-------	------	---

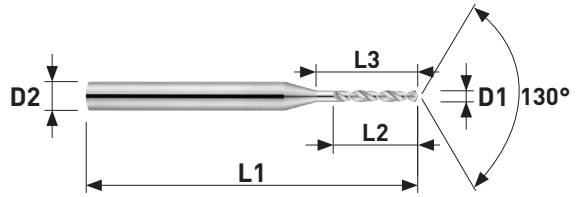

Art. N°	D1 0/-0.004	L2	L3	D2 h6	L1	N
3023-1.70	1.70	11.20	13.40	3.00	38	■
3023-1.71	1.71	11.20	13.40	3.00	38	■
3023-1.72	1.72	11.20	13.40	3.00	38	■
3023-1.73	1.73	11.20	13.40	3.00	38	■
3023-1.74	1.74	11.20	13.40	3.00	38	■
3023-1.75	1.75	11.20	13.40	3.00	38	■
3023-1.76	1.76	11.20	13.40	3.00	38	■
3023-1.77	1.77	11.20	13.40	3.00	38	■
3023-1.78	1.78	11.20	13.40	3.00	38	■
3023-1.79	1.79	11.20	13.40	3.00	38	■
3023-1.80	1.80	11.20	13.40	3.00	38	■
3023-1.81	1.81	11.20	13.40	3.00	38	■
3023-1.82	1.82	11.20	13.40	3.00	38	■
3023-1.83	1.83	11.20	13.40	3.00	38	■
3023-1.84	1.84	11.20	13.40	3.00	38	■
3023-1.85	1.85	11.20	13.40	3.00	38	■
3023-1.86	1.86	11.20	13.40	3.00	38	■
3023-1.87	1.87	11.20	13.40	3.00	38	■
3023-1.88	1.88	11.20	13.40	3.00	38	■
3023-1.89	1.89	11.20	13.40	3.00	38	■
3023-1.90	1.90	11.20	13.40	3.00	38	■
3023-1.91	1.91	11.20	13.40	3.00	38	■
3023-1.92	1.92	11.20	13.40	3.00	38	■
3023-1.93	1.93	11.20	13.40	3.00	38	■
3023-1.94	1.94	11.20	13.40	3.00	38	■
3023-1.95	1.95	11.20	13.40	3.00	38	■
3023-1.96	1.96	11.20	13.40	3.00	38	■
3023-1.97	1.97	11.20	13.40	3.00	38	■
3023-1.98	1.98	11.20	13.40	3.00	38	■
3023-1.99	1.99	11.20	13.40	3.00	38	■
3023-2.00	2.00	11.20	13.40	3.00	38	■
3023-2.01	2.01	12.50	14.00	3.00	38	■
3023-2.02	2.02	12.50	14.00	3.00	38	■
3023-2.03	2.03	12.50	14.00	3.00	38	■
3023-2.04	2.04	12.50	14.00	3.00	38	■
3023-2.05	2.05	12.50	14.00	3.00	38	■
3023-2.06	2.06	12.50	14.00	3.00	38	■
3023-2.07	2.07	12.50	14.00	3.00	38	■
3023-2.08	2.08	12.50	14.00	3.00	38	■
3023-2.09	2.09	12.50	14.00	3.00	38	■

Art. N°	D1 0/-0.004	L2	L3	D2 h6	L1	N
3023-2.10	2.10	12.50	14.00	3.00	38	■
3023-2.11	2.11	12.50	14.00	3.00	38	■
3023-2.12	2.12	12.50	14.00	3.00	38	■
3023-2.13	2.13	12.50	14.00	3.00	38	■
3023-2.14	2.14	12.50	14.00	3.00	38	■
3023-2.15	2.15	12.50	14.00	3.00	38	■
3023-2.16	2.16	12.50	14.00	3.00	38	■
3023-2.17	2.17	12.50	14.00	3.00	38	■
3023-2.18	2.18	12.50	14.00	3.00	38	■
3023-2.19	2.19	12.50	14.00	3.00	38	■
3023-2.20	2.20	12.50	14.00	3.00	38	■
3023-2.21	2.21	12.50	14.00	3.00	38	■
3023-2.22	2.22	12.50	14.00	3.00	38	■
3023-2.23	2.23	12.50	14.00	3.00	38	■
3023-2.24	2.24	12.50	14.00	3.00	38	■
3023-2.25	2.25	12.50	14.00	3.00	38	■
3023-2.26	2.26	12.50	14.00	3.00	38	■
3023-2.27	2.27	12.50	14.00	3.00	38	■
3023-2.28	2.28	12.50	14.00	3.00	38	■
3023-2.29	2.29	12.50	14.00	3.00	38	■
3023-2.30	2.30	12.50	14.00	3.00	38	■
3023-2.31	2.31	12.50	14.00	3.00	38	■
3023-2.32	2.32	12.50	14.00	3.00	38	■
3023-2.33	2.33	12.50	14.00	3.00	38	■
3023-2.34	2.34	12.50	14.00	3.00	38	■
3023-2.35	2.35	12.50	14.00	3.00	38	■
3023-2.36	2.36	12.50	14.00	3.00	38	■
3023-2.37	2.37	12.50	14.00	3.00	38	■
3023-2.38	2.38	12.50	14.00	3.00	38	■
3023-2.39	2.39	12.50	14.00	3.00	38	■
3023-2.40	2.40	12.50	14.00	3.00	38	■
3023-2.41	2.41	12.50	14.00	3.00	38	■
3023-2.42	2.42	12.50	14.00	3.00	38	■
3023-2.43	2.43	12.50	14.00	3.00	38	■
3023-2.44	2.44	12.50	14.00	3.00	38	■
3023-2.45	2.45	12.50	14.00	3.00	38	■
3023-2.46	2.46	12.50	14.00	3.00	38	■
3023-2.47	2.47	12.50	14.00	3.00	38	■
3023-2.48	2.48	12.50	14.00	3.00	38	■
3023-2.49	2.49	12.50	14.00	3.00	38	■

**Forets
Bohrer
Drills**

3023

SWISS  MADE

MD VHM HM	λ 35°	6xD1	Z = 2	130°	
-----------------	---------------	------	-------	------	---

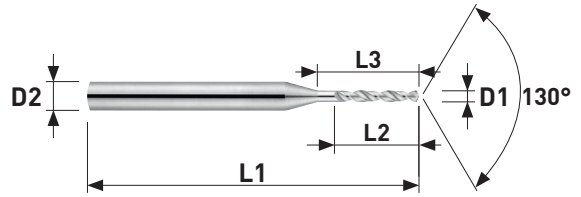

Art. N°	D1 0/-0.004	L2	L3	D2 h6	L1	N
3023-2.50	2.50	14.00	17.00	3.00	38	■
3023-2.51	2.51	14.00	17.00	3.00	38	■
3023-2.52	2.52	14.00	17.00	3.00	38	■
3023-2.53	2.53	14.00	17.00	3.00	38	■
3023-2.54	2.54	14.00	17.00	3.00	38	■
3023-2.55	2.55	14.00	17.00	3.00	38	■
3023-2.56	2.56	14.00	17.00	3.00	38	■
3023-2.57	2.57	14.00	17.00	3.00	38	■
3023-2.58	2.58	14.00	17.00	3.00	38	■
3023-2.59	2.59	14.00	17.00	3.00	38	■
3023-2.60	2.60	14.00	17.00	3.00	38	■
3023-2.61	2.61	14.00	17.00	3.00	38	■
3023-2.62	2.62	14.00	17.00	3.00	38	■
3023-2.63	2.63	14.00	17.00	3.00	38	■
3023-2.64	2.64	14.00	17.00	3.00	38	■
3023-2.65	2.65	14.00	17.00	3.00	38	■
3023-2.66	2.66	14.00	17.00	3.00	38	■
3023-2.67	2.67	14.00	17.00	3.00	38	■
3023-2.68	2.68	14.00	17.00	3.00	38	■
3023-2.69	2.69	14.00	17.00	3.00	38	■
3023-2.70	2.70	14.00	17.00	3.00	38	■
3023-2.71	2.71	14.00	17.00	3.00	38	■
3023-2.72	2.72	14.00	17.00	3.00	38	■
3023-2.73	2.73	14.00	17.00	3.00	38	■
3023-2.74	2.74	14.00	17.00	3.00	38	■
3023-2.75	2.75	14.00	17.00	3.00	38	■
3023-2.76	2.76	14.00	17.00	3.00	38	■
3023-2.77	2.77	14.00	17.00	3.00	38	■
3023-2.78	2.78	14.00	17.00	3.00	38	■
3023-2.79	2.79	14.00	17.00	3.00	38	■
3023-2.80	2.80	14.00	17.00	3.00	38	■
3023-2.81	2.81	14.00	17.00	3.00	38	■
3023-2.82	2.82	14.00	17.00	3.00	38	■
3023-2.83	2.83	14.00	17.00	3.00	38	■
3023-2.84	2.84	14.00	17.00	3.00	38	■
3023-2.85	2.85	14.00	17.00	3.00	38	■
3023-2.86	2.86	14.00	17.00	3.00	38	■
3023-2.87	2.87	14.00	17.00	3.00	38	■
3023-2.88	2.88	14.00	17.00	3.00	38	■
3023-2.89	2.89	14.00	17.00	3.00	38	■

Art. N°	D1 0/-0.004	L2	L3	D2 h6	L1	N
3023-2.90	2.90	14.00	17.00	3.00	38	■
3023-2.91	2.91	14.00	17.00	3.00	38	■
3023-2.92	2.92	14.00	17.00	3.00	38	■
3023-2.93	2.93	14.00	17.00	3.00	38	■
3023-2.94	2.94	14.00	17.00	3.00	38	■
3023-2.95	2.95	14.00	17.00	3.00	38	■
3023-2.96	2.96	14.00	17.00	3.00	38	■
3023-2.97	2.97	14.00	17.00	3.00	38	■
3023-2.98	2.98	14.00	17.00	3.00	38	■
3023-2.99	2.99	14.00	17.00	3.00	38	■
3023-3.00	3.00	14.00	17.00	3.00	38	■



Forets Bohrer Drills

3026

SWISS  MADE

MD VHM HM	λ 25°	12xD1	Z = 2	130°	
-----------------	---------------	-------	-------	------	---

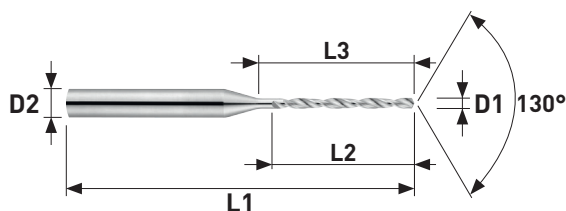

Art. N°	D1 h6	L2	L3	D2 h6	L1	N
3026-0.20	0.20	2.40	3.50	3.00	38	■
3026-0.21	0.21	2.50	3.50	3.00	38	■
3026-0.22	0.22	2.70	3.50	3.00	38	■
3026-0.23	0.23	2.80	3.50	3.00	38	■
3026-0.24	0.24	2.90	4.00	3.00	38	■
3026-0.25	0.25	3.00	4.00	3.00	38	■
3026-0.26	0.26	3.10	4.00	3.00	38	■
3026-0.27	0.27	3.30	4.00	3.00	38	■
3026-0.28	0.28	3.40	4.50	3.00	38	■
3026-0.29	0.29	3.50	4.50	3.00	38	■
3026-0.30	0.30	3.60	4.50	3.00	38	■
3026-0.31	0.31	3.70	4.50	3.00	38	■
3026-0.32	0.32	3.90	5.00	3.00	38	■
3026-0.33	0.33	4.00	5.00	3.00	38	■
3026-0.34	0.34	4.10	5.00	3.00	38	■
3026-0.35	0.35	4.20	5.00	3.00	38	■
3026-0.36	0.36	4.30	5.50	3.00	38	■
3026-0.37	0.37	4.50	5.50	3.00	38	■
3026-0.38	0.38	4.60	5.50	3.00	38	■
3026-0.39	0.39	4.70	5.50	3.00	38	■
3026-0.40	0.40	4.80	6.00	3.00	38	■
3026-0.41	0.41	4.90	6.00	3.00	38	■
3026-0.42	0.42	5.10	6.00	3.00	38	■
3026-0.43	0.43	5.20	6.00	3.00	38	■
3026-0.44	0.44	5.30	6.50	3.00	38	■
3026-0.45	0.45	5.40	6.50	3.00	38	■
3026-0.46	0.46	5.50	6.50	3.00	38	■
3026-0.47	0.47	5.70	6.50	3.00	38	■
3026-0.48	0.48	5.80	7.00	3.00	38	■
3026-0.49	0.49	5.90	7.00	3.00	38	■
3026-0.50	0.50	6.00	7.00	3.00	38	■
3026-0.51	0.51	6.10	7.00	3.00	38	■
3026-0.52	0.52	6.30	7.50	3.00	38	■
3026-0.53	0.53	6.40	7.50	3.00	38	■
3026-0.54	0.54	6.50	7.50	3.00	38	■
3026-0.55	0.55	6.60	7.50	3.00	38	■
3026-0.56	0.56	6.70	8.00	3.00	38	■
3026-0.57	0.57	6.90	8.00	3.00	38	■
3026-0.58	0.58	7.00	8.00	3.00	38	■
3026-0.59	0.59	7.10	8.00	3.00	38	■
3026-0.60	0.60	7.20	9.00	3.00	38	■

Art. N°	D1 h6	L2	L3	D2 h6	L1	N
3026-0.61	0.61	7.30	9.00	3.00	38	■
3026-0.62	0.62	7.50	9.00	3.00	38	■
3026-0.63	0.63	7.60	9.00	3.00	38	■
3026-0.64	0.64	7.70	9.50	3.00	38	■
3026-0.65	0.65	7.80	9.50	3.00	38	■
3026-0.66	0.66	7.90	9.50	3.00	38	■
3026-0.67	0.67	8.10	9.50	3.00	38	■
3026-0.68	0.68	8.20	10.00	3.00	38	■
3026-0.69	0.69	8.30	10.00	3.00	38	■
3026-0.70	0.70	8.40	10.00	3.00	38	■
3026-0.71	0.71	8.50	10.00	3.00	38	■
3026-0.72	0.72	8.70	10.50	3.00	38	■
3026-0.73	0.73	8.80	10.50	3.00	38	■
3026-0.74	0.74	8.90	10.50	3.00	38	■
3026-0.75	0.75	9.00	10.50	3.00	38	■
3026-0.76	0.76	9.10	11.00	3.00	38	■
3026-0.77	0.77	9.30	11.00	3.00	38	■
3026-0.78	0.78	9.40	11.00	3.00	38	■
3026-0.79	0.79	9.50	11.00	3.00	38	■
3026-0.80	0.80	9.60	11.50	3.00	38	■
3026-0.81	0.81	9.70	11.50	3.00	38	■
3026-0.82	0.82	9.90	11.50	3.00	38	■
3026-0.83	0.83	10.00	11.50	3.00	38	■
3026-0.84	0.84	10.10	12.00	3.00	38	■
3026-0.85	0.85	10.20	12.00	3.00	38	■
3026-0.86	0.86	10.30	12.00	3.00	38	■
3026-0.87	0.87	10.50	12.00	3.00	38	■
3026-0.88	0.88	10.60	12.50	3.00	38	■
3026-0.89	0.89	10.70	12.50	3.00	38	■
3026-0.90	0.90	10.80	12.50	3.00	38	■
3026-0.91	0.91	10.90	12.50	3.00	38	■
3026-0.92	0.92	11.10	13.00	3.00	38	■
3026-0.93	0.93	11.20	13.00	3.00	38	■
3026-0.94	0.94	11.30	13.00	3.00	38	■
3026-0.95	0.95	11.40	13.00	3.00	38	■
3026-0.96	0.96	11.50	13.50	3.00	38	■
3026-0.97	0.97	11.70	13.50	3.00	38	■
3026-0.98	0.98	11.80	13.50	3.00	38	■
3026-0.99	0.99	11.90	13.50	3.00	38	■
3026-1.00	1.00	12.00	14.50	3.00	38	■
3026-1.01	1.01	12.10	14.50	3.00	38	■

Forets Bohrer Drills

3026

SWISS  MADE

MD VHM HM	λ 25°	12xD1	Z = 2	130°	
-----------------	---------------	-------	-------	------	---

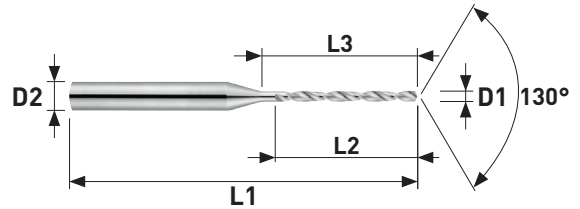

Art. N°	D1 h6	L2	L3	D2 h6	L1	N
3026-1.02	1.02	12.30	14.50	3.00	38	■
3026-1.03	1.03	12.40	14.50	3.00	38	■
3026-1.04	1.04	12.50	15.00	3.00	38	■
3026-1.05	1.05	12.60	15.00	3.00	38	■
3026-1.06	1.06	12.70	15.00	3.00	38	■
3026-1.07	1.07	12.90	15.00	3.00	38	■
3026-1.08	1.08	13.00	15.50	3.00	38	■
3026-1.09	1.09	13.10	15.50	3.00	38	■
3026-1.10	1.10	13.20	15.50	3.00	38	■
3026-1.11	1.11	13.30	15.50	3.00	38	■
3026-1.12	1.12	13.50	16.00	3.00	38	■
3026-1.13	1.13	13.60	16.00	3.00	38	■
3026-1.14	1.14	13.70	16.00	3.00	38	■
3026-1.15	1.15	13.80	16.00	3.00	38	■
3026-1.16	1.16	13.90	16.50	3.00	38	■
3026-1.17	1.17	14.10	16.50	3.00	38	■
3026-1.18	1.18	14.20	16.50	3.00	38	■
3026-1.19	1.19	14.30	16.50	3.00	38	■
3026-1.20	1.20	14.40	17.00	3.00	38	■
3026-1.21	1.21	14.50	17.00	3.00	38	■
3026-1.22	1.22	14.70	17.00	3.00	38	■
3026-1.23	1.23	14.80	17.00	3.00	38	■
3026-1.24	1.24	14.90	17.50	3.00	38	■
3026-1.25	1.25	15.00	17.50	3.00	38	■
3026-1.26	1.26	15.10	17.50	3.00	50	■
3026-1.27	1.27	15.30	17.50	3.00	50	■
3026-1.28	1.28	15.40	18.00	3.00	50	■
3026-1.29	1.29	15.50	18.00	3.00	50	■
3026-1.30	1.30	15.60	18.00	3.00	50	■
3026-1.31	1.31	15.70	18.00	3.00	50	■
3026-1.32	1.32	15.90	18.50	3.00	50	■
3026-1.33	1.33	16.00	18.50	3.00	50	■
3026-1.34	1.34	16.10	18.50	3.00	50	■
3026-1.35	1.35	16.20	18.50	3.00	50	■
3026-1.36	1.36	16.30	19.00	3.00	50	■
3026-1.37	1.37	16.50	19.00	3.00	50	■
3026-1.38	1.38	16.60	19.00	3.00	50	■
3026-1.39	1.39	16.70	19.00	3.00	50	■
3026-1.40	1.40	16.80	19.50	3.00	50	■
3026-1.41	1.41	16.90	19.50	3.00	50	■
3026-1.42	1.42	17.10	19.50	3.00	50	■

Art. N°	D1 h6	L2	L3	D2 h6	L1	N
3026-1.43	1.43	17.20	19.50	3.00	50	■
3026-1.44	1.44	17.30	20.00	3.00	50	■
3026-1.45	1.45	17.40	20.00	3.00	50	■
3026-1.46	1.46	17.50	20.00	3.00	50	■
3026-1.47	1.47	17.70	20.00	3.00	50	■
3026-1.48	1.48	17.80	20.50	3.00	50	■
3026-1.49	1.49	17.90	20.50	3.00	50	■
3026-1.50	1.50	18.00	21.00	3.00	50	■
3026-1.51	1.51	18.10	21.00	3.00	50	■
3026-1.52	1.52	18.30	21.00	3.00	50	■
3026-1.53	1.53	18.40	21.00	3.00	50	■
3026-1.54	1.54	18.50	21.50	3.00	50	■
3026-1.55	1.55	18.60	21.50	3.00	50	■
3026-1.56	1.56	18.70	21.50	3.00	50	■
3026-1.57	1.57	18.90	21.50	3.00	50	■
3026-1.58	1.58	19.00	22.00	3.00	50	■
3026-1.59	1.59	19.10	22.00	3.00	50	■
3026-1.60	1.60	19.20	22.00	3.00	50	■
3026-1.61	1.61	19.30	22.00	3.00	50	■
3026-1.62	1.62	19.40	22.50	3.00	50	■
3026-1.63	1.63	19.60	22.50	3.00	50	■
3026-1.64	1.64	19.70	22.50	3.00	50	■
3026-1.65	1.65	19.80	22.50	3.00	50	■
3026-1.66	1.66	19.90	23.00	3.00	50	■
3026-1.67	1.67	20.10	23.00	3.00	50	■
3026-1.68	1.68	20.20	23.00	3.00	50	■
3026-1.69	1.69	20.30	23.00	3.00	50	■
3026-1.70	1.70	20.40	23.50	3.00	50	■
3026-1.71	1.71	20.50	23.50	3.00	50	■
3026-1.72	1.72	20.70	23.50	3.00	50	■
3026-1.73	1.73	20.80	23.50	3.00	50	■
3026-1.74	1.74	20.90	24.00	3.00	50	■
3026-1.75	1.75	21.00	24.00	3.00	50	■
3026-1.76	1.76	21.10	24.00	3.00	50	■
3026-1.77	1.77	21.30	24.00	3.00	50	■
3026-1.78	1.78	21.40	24.50	3.00	50	■
3026-1.79	1.79	21.50	24.50	3.00	50	■
3026-1.80	1.80	21.60	25.00	3.00	50	■
3026-1.81	1.81	21.70	25.00	3.00	50	■
3026-1.82	1.82	21.90	25.00	3.00	50	■
3026-1.83	1.83	22.00	25.00	3.00	50	■

■ = Disponible/Verfügbar/Available
 Revêtement sur demande/Beschichtung auf Anfrage/Coating on request

**Forets
Bohrer
Drills**

3026

SWISS  MADE

MD VHM HM	λ 25°	12xD1	Z = 2	130°	
-----------------	---------------	-------	-------	------	---

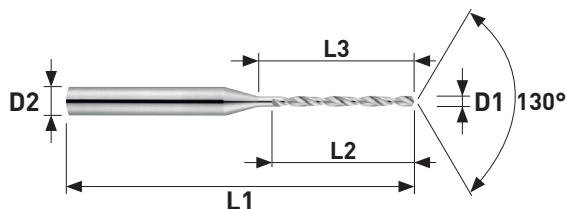

Art. N°	D1 h6	L2	L3	D2 h6	L1	N
3026-1.84	1.84	22.10	25.50	3.00	50	■
3026-1.85	1.85	22.20	25.50	3.00	50	■
3026-1.86	1.86	22.30	25.50	3.00	50	■
3026-1.87	1.87	22.50	25.50	3.00	50	■
3026-1.88	1.88	22.60	26.00	3.00	50	■
3026-1.89	1.89	22.70	26.00	3.00	50	■
3026-1.90	1.90	22.80	26.00	3.00	50	■
3026-1.91	1.91	22.90	26.00	3.00	50	■
3026-1.92	1.92	23.10	26.50	3.00	50	■
3026-1.93	1.93	23.20	26.50	3.00	50	■
3026-1.94	1.94	23.30	26.50	3.00	50	■
3026-1.95	1.95	23.40	26.50	3.00	50	■
3026-1.96	1.96	23.50	27.00	3.00	50	■
3026-1.97	1.97	23.70	27.00	3.00	50	■
3026-1.98	1.98	23.80	27.00	3.00	50	■
3026-1.99	1.99	23.90	27.00	3.00	50	■
3026-2.00	2.00	24.00	27.00	3.00	50	■

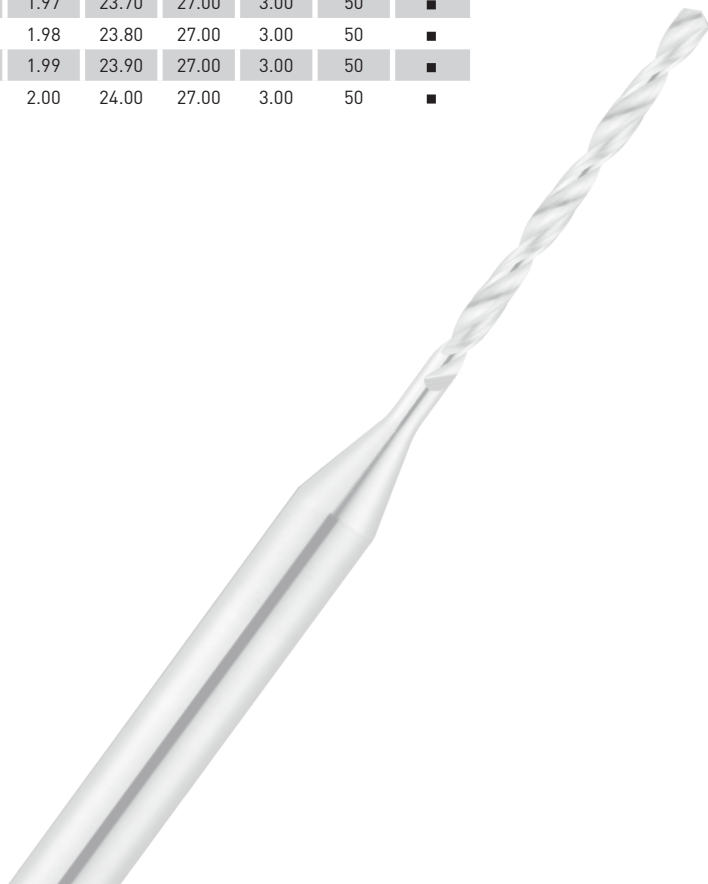

Forets Bohrer Drills

3030

SWISS  MADE

MD VHM HM	λ 35°	5xD1	Z = 3	140°	
-----------------	---------------	------	-------	------	---

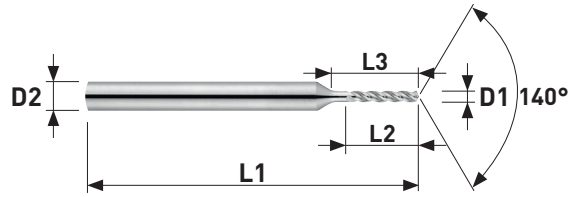

Art. N°	D1 h6	L2	L3	D2 h6	L1	N
3030-0.20	0.20	1.00	1.50	3.00	38	■
3030-0.21	0.21	1.05	1.50	3.00	38	■
3030-0.22	0.22	1.10	1.60	3.00	38	■
3030-0.23	0.23	1.15	1.60	3.00	38	■
3030-0.24	0.24	1.20	1.70	3.00	38	■
3030-0.25	0.25	1.25	1.70	3.00	38	■
3030-0.26	0.26	1.30	1.80	3.00	38	■
3030-0.27	0.27	1.35	1.80	3.00	38	■
3030-0.28	0.28	1.40	1.90	3.00	38	■
3030-0.29	0.29	1.45	1.90	3.00	38	■
3030-0.30	0.30	1.50	2.00	3.00	38	■
3030-0.31	0.31	1.55	2.00	3.00	38	■
3030-0.32	0.32	1.60	2.10	3.00	38	■
3030-0.33	0.33	1.65	2.10	3.00	38	■
3030-0.34	0.34	1.70	2.20	3.00	38	■
3030-0.35	0.35	1.75	2.20	3.00	38	■
3030-0.36	0.36	1.80	2.30	3.00	38	■
3030-0.37	0.37	1.85	2.30	3.00	38	■
3030-0.38	0.38	1.90	2.40	3.00	38	■
3030-0.39	0.39	1.95	2.40	3.00	38	■
3030-0.40	0.40	2.00	2.50	3.00	38	■
3030-0.41	0.41	2.05	2.50	3.00	38	■
3030-0.42	0.42	2.10	2.60	3.00	38	■
3030-0.43	0.43	2.15	2.60	3.00	38	■
3030-0.44	0.44	2.20	2.70	3.00	38	■
3030-0.45	0.45	2.25	2.70	3.00	38	■
3030-0.46	0.46	2.30	2.80	3.00	38	■
3030-0.47	0.47	2.35	2.80	3.00	38	■
3030-0.48	0.48	2.40	2.90	3.00	38	■
3030-0.49	0.49	2.45	2.90	3.00	38	■
3030-0.50	0.50	2.50	3.00	3.00	38	■
3030-0.51	0.51	2.55	3.00	3.00	38	■
3030-0.52	0.52	2.60	3.10	3.00	38	■
3030-0.53	0.53	2.65	3.10	3.00	38	■
3030-0.54	0.54	2.70	3.20	3.00	38	■
3030-0.55	0.55	2.75	3.20	3.00	38	■
3030-0.56	0.56	2.80	3.30	3.00	38	■
3030-0.57	0.57	2.85	3.30	3.00	38	■
3030-0.58	0.58	2.90	3.40	3.00	38	■
3030-0.59	0.59	2.95	3.40	3.00	38	■
3030-0.60	0.60	3.00	3.50	3.00	38	■
3030-0.61	0.61	3.05	3.50	3.00	38	■
3030-0.62	0.62	3.10	3.60	3.00	38	■
3030-0.63	0.63	3.15	3.60	3.00	38	■
3030-0.64	0.64	3.20	3.70	3.00	38	■
3030-0.65	0.65	3.25	3.70	3.00	38	■
3030-0.66	0.66	3.30	3.80	3.00	38	■

Art. N°	D1 h6	L2	L3	D2 h6	L1	N
3030-0.67	0.67	3.35	3.80	3.00	38	■
3030-0.68	0.68	3.40	3.90	3.00	38	■
3030-0.69	0.69	3.45	3.90	3.00	38	■
3030-0.70	0.70	3.50	4.00	3.00	38	■
3030-0.71	0.71	3.55	4.00	3.00	38	■
3030-0.72	0.72	3.60	4.10	3.00	38	■
3030-0.73	0.73	3.65	4.10	3.00	38	■
3030-0.74	0.74	3.70	4.20	3.00	38	■
3030-0.75	0.75	3.75	4.20	3.00	38	■
3030-0.76	0.76	3.80	4.30	3.00	38	■
3030-0.77	0.77	3.85	4.30	3.00	38	■
3030-0.78	0.78	3.90	4.40	3.00	38	■
3030-0.79	0.79	3.95	4.40	3.00	38	■
3030-0.80	0.80	4.00	4.50	3.00	38	■
3030-0.81	0.81	4.05	4.50	3.00	38	■
3030-0.82	0.82	4.10	4.60	3.00	38	■
3030-0.83	0.83	4.15	4.60	3.00	38	■
3030-0.84	0.84	4.20	4.70	3.00	38	■
3030-0.85	0.85	4.25	4.70	3.00	38	■
3030-0.86	0.86	4.30	4.80	3.00	38	■
3030-0.87	0.87	4.35	4.80	3.00	38	■
3030-0.88	0.88	4.40	4.90	3.00	38	■
3030-0.89	0.89	4.45	4.90	3.00	38	■
3030-0.90	0.90	4.50	5.00	3.00	38	■
3030-0.91	0.91	4.55	5.00	3.00	38	■
3030-0.92	0.92	4.60	5.10	3.00	38	■
3030-0.93	0.93	4.65	5.10	3.00	38	■
3030-0.94	0.94	4.70	5.20	3.00	38	■
3030-0.95	0.95	4.75	5.20	3.00	38	■
3030-0.96	0.96	4.80	5.30	3.00	38	■
3030-0.97	0.97	4.85	5.30	3.00	38	■
3030-0.98	0.98	4.90	5.40	3.00	38	■
3030-0.99	0.99	4.95	5.40	3.00	38	■
3030-1.00	1.00	5.00	6.50	3.00	38	■
3030-1.01	1.01	5.05	6.50	3.00	38	■
3030-1.02	1.02	5.10	6.50	3.00	38	■
3030-1.03	1.03	5.15	6.50	3.00	38	■
3030-1.04	1.04	5.20	6.50	3.00	38	■
3030-1.05	1.05	5.25	6.50	3.00	38	■
3030-1.06	1.06	5.30	6.50	3.00	38	■
3030-1.07	1.07	5.35	7.50	3.00	38	■
3030-1.08	1.08	5.40	7.50	3.00	38	■
3030-1.09	1.09	5.45	7.50	3.00	38	■
3030-1.10	1.10	5.50	7.50	3.00	38	■
3030-1.11	1.11	5.55	7.50	3.00	38	■
3030-1.12	1.12	5.60	7.50	3.00	38	■
3030-1.13	1.13	5.65	7.50	3.00	38	■

■ = Disponible/Verfügbar/Available
 Revêtement sur demande/Beschichtung auf Anfrage/Coating on request

Forets Bohrer Drills

3030

SWISS  MADE

MD VHM HM	λ 35°	5xD1	Z = 3	140°	
-----------------	---------------	------	-------	------	---

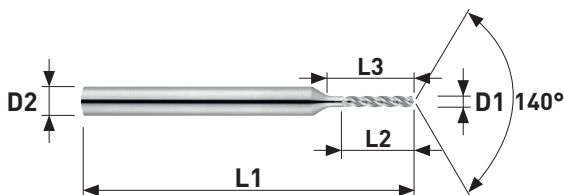

Art. N°	D1 h6	L2	L3	D2 h6	L1	N
3030-1.14	1.14	5.70	7.50	3.00	38	■
3030-1.15	1.15	5.75	7.50	3.00	38	■
3030-1.16	1.16	5.80	7.50	3.00	38	■
3030-1.17	1.17	5.85	7.50	3.00	38	■
3030-1.18	1.18	5.90	8.50	3.00	38	■
3030-1.19	1.19	5.95	8.50	3.00	38	■
3030-1.20	1.20	6.00	8.50	3.00	38	■
3030-1.21	1.21	6.05	8.50	3.00	38	■
3030-1.22	1.22	6.10	8.50	3.00	38	■
3030-1.23	1.23	6.15	8.50	3.00	38	■
3030-1.24	1.24	6.20	8.50	3.00	38	■
3030-1.25	1.25	6.25	8.50	3.00	38	■
3030-1.26	1.26	6.30	8.50	3.00	38	■
3030-1.27	1.27	6.35	8.50	3.00	38	■
3030-1.28	1.28	6.40	8.50	3.00	38	■
3030-1.29	1.29	6.45	8.50	3.00	38	■
3030-1.30	1.30	6.50	8.50	3.00	38	■
3030-1.31	1.31	6.55	8.50	3.00	38	■
3030-1.32	1.32	6.60	8.50	3.00	38	■
3030-1.33	1.33	6.65	9.50	3.00	38	■
3030-1.34	1.34	6.70	9.50	3.00	38	■
3030-1.35	1.35	6.75	9.50	3.00	38	■
3030-1.36	1.36	6.80	9.50	3.00	38	■
3030-1.37	1.37	6.85	9.50	3.00	38	■
3030-1.38	1.38	6.90	9.50	3.00	38	■
3030-1.39	1.39	6.95	9.50	3.00	38	■
3030-1.40	1.40	7.00	9.50	3.00	38	■
3030-1.41	1.41	7.05	9.50	3.00	38	■
3030-1.42	1.42	7.10	9.50	3.00	38	■
3030-1.43	1.43	7.15	9.50	3.00	38	■
3030-1.44	1.44	7.20	9.50	3.00	38	■
3030-1.45	1.45	7.25	9.50	3.00	38	■
3030-1.46	1.46	7.30	9.50	3.00	38	■
3030-1.47	1.47	7.35	9.50	3.00	38	■
3030-1.48	1.48	7.40	9.50	3.00	38	■
3030-1.49	1.49	7.45	9.50	3.00	38	■
3030-1.50	1.50	7.50	9.50	3.00	38	■
3030-1.51	1.51	7.55	10.50	3.00	38	■
3030-1.52	1.52	7.60	10.50	3.00	38	■
3030-1.53	1.53	7.65	10.50	3.00	38	■
3030-1.54	1.54	7.70	10.50	3.00	38	■
3030-1.55	1.55	7.75	10.50	3.00	38	■
3030-1.56	1.56	7.80	10.50	3.00	38	■
3030-1.57	1.57	7.85	10.50	3.00	38	■
3030-1.58	1.58	7.90	10.50	3.00	38	■
3030-1.59	1.59	7.95	10.50	3.00	38	■
3030-1.60	1.60	8.00	10.50	3.00	38	■

Art. N°	D1 h6	L2	L3	D2 h6	L1	N
3030-1.61	1.61	8.05	10.50	3.00	38	■
3030-1.62	1.62	8.10	10.50	3.00	38	■
3030-1.63	1.63	8.15	10.50	3.00	38	■
3030-1.64	1.64	8.20	10.50	3.00	38	■
3030-1.65	1.65	8.25	10.50	3.00	38	■
3030-1.66	1.66	8.30	10.50	3.00	38	■
3030-1.67	1.67	8.35	10.50	3.00	38	■
3030-1.68	1.68	8.40	10.50	3.00	38	■
3030-1.69	1.69	8.45	10.50	3.00	38	■
3030-1.70	1.70	8.50	10.50	3.00	38	■
3030-1.71	1.71	8.55	11.50	3.00	38	■
3030-1.72	1.72	8.60	11.50	3.00	38	■
3030-1.73	1.73	8.65	11.50	3.00	38	■
3030-1.74	1.74	8.70	11.50	3.00	38	■
3030-1.75	1.75	8.75	11.50	3.00	38	■
3030-1.76	1.76	8.80	11.50	3.00	38	■
3030-1.77	1.77	8.85	11.50	3.00	38	■
3030-1.78	1.78	8.90	11.50	3.00	38	■
3030-1.79	1.79	8.95	11.50	3.00	38	■
3030-1.80	1.80	9.00	11.50	3.00	38	■
3030-1.81	1.81	9.05	11.50	3.00	38	■
3030-1.82	1.82	9.10	11.50	3.00	38	■
3030-1.83	1.83	9.15	11.50	3.00	38	■
3030-1.84	1.84	9.20	11.50	3.00	38	■
3030-1.85	1.85	9.25	11.50	3.00	38	■
3030-1.86	1.86	9.30	11.50	3.00	38	■
3030-1.87	1.87	9.35	11.50	3.00	38	■
3030-1.88	1.88	9.40	11.50	3.00	38	■
3030-1.89	1.89	9.45	11.50	3.00	38	■
3030-1.90	1.90	9.50	11.50	3.00	38	■
3030-1.91	1.91	9.55	12.50	3.00	38	■
3030-1.92	1.92	9.60	12.50	3.00	38	■
3030-1.93	1.93	9.65	12.50	3.00	38	■
3030-1.94	1.94	9.70	12.50	3.00	38	■
3030-1.95	1.95	9.75	12.50	3.00	38	■
3030-1.96	1.96	9.80	12.50	3.00	38	■
3030-1.97	1.97	9.85	12.50	3.00	38	■
3030-1.98	1.98	9.90	12.50	3.00	38	■
3030-1.99	1.99	9.95	12.50	3.00	38	■
3030-2.00	2.00	10.00	12.50	3.00	38	■
3030-2.01	2.01	10.05	12.50	3.00	38	■
3030-2.02	2.02	10.10	12.50	3.00	38	■
3030-2.03	2.03	10.15	12.50	3.00	38	■
3030-2.04	2.04	10.20	12.50	3.00	38	■
3030-2.05	2.05	10.25	12.50	3.00	38	■
3030-2.06	2.06	10.30	12.50	3.00	38	■
3030-2.07	2.07	10.35	12.50	3.00	38	■

Forets Bohrer Drills

3030

SWISS  MADE

MD VHM HM	λ 35°	5xD1	Z = 3	140°	
-----------------	---------------	------	-------	------	---

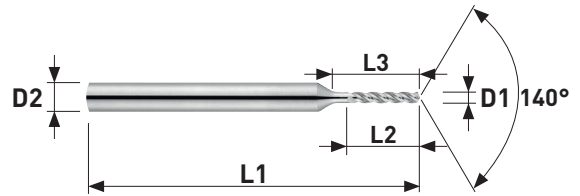







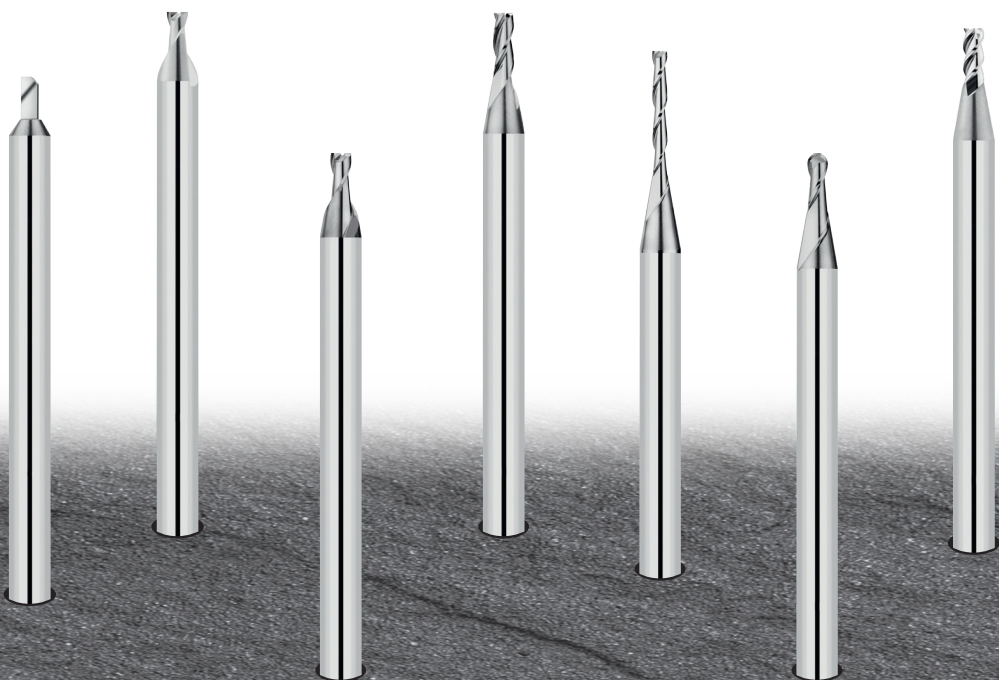

Art. N°	D1 h6	L2	L3	D2 h6	L1	N
3030-2.08	2.08	10.40	12.50	3.00	38	■
3030-2.09	2.09	10.45	12.50	3.00	38	■
3030-2.10	2.10	10.50	12.50	3.00	38	■
3030-2.11	2.11	10.55	12.50	3.00	38	■
3030-2.12	2.12	10.60	12.50	3.00	38	■
3030-2.13	2.13	10.65	13.50	3.00	38	■
3030-2.14	2.14	10.70	13.50	3.00	38	■
3030-2.15	2.15	10.75	13.50	3.00	38	■
3030-2.16	2.16	10.80	13.50	3.00	38	■
3030-2.17	2.17	10.85	13.50	3.00	38	■
3030-2.18	2.18	10.90	13.50	3.00	38	■
3030-2.19	2.19	10.95	13.50	3.00	38	■
3030-2.20	2.20	11.00	13.50	3.00	38	■
3030-2.21	2.21	11.05	13.50	3.00	38	■
3030-2.22	2.22	11.10	13.50	3.00	38	■
3030-2.23	2.23	11.15	13.50	3.00	38	■
3030-2.24	2.24	11.20	13.50	3.00	38	■
3030-2.25	2.25	11.25	13.50	3.00	38	■
3030-2.26	2.26	11.30	13.50	3.00	38	■
3030-2.27	2.27	11.35	13.50	3.00	38	■
3030-2.28	2.28	11.40	13.50	3.00	38	■
3030-2.29	2.29	11.45	13.50	3.00	38	■
3030-2.30	2.30	11.50	13.50	3.00	38	■
3030-2.31	2.31	11.55	13.50	3.00	38	■
3030-2.32	2.32	11.60	13.50	3.00	38	■
3030-2.33	2.33	11.65	13.50	3.00	38	■
3030-2.34	2.34	11.70	13.50	3.00	38	■
3030-2.35	2.35	11.75	13.50	3.00	38	■
3030-2.36	2.36	11.80	13.50	3.00	38	■
3030-2.37	2.37	11.85	14.50	3.00	38	■
3030-2.38	2.38	11.90	14.50	3.00	38	■
3030-2.39	2.39	11.95	14.50	3.00	38	■
3030-2.40	2.40	12.00	14.50	3.00	38	■
3030-2.41	2.41	12.05	14.50	3.00	38	■
3030-2.42	2.42	12.10	14.50	3.00	38	■
3030-2.43	2.43	12.15	14.50	3.00	38	■
3030-2.44	2.44	12.20	14.50	3.00	38	■
3030-2.45	2.45	12.25	14.50	3.00	38	■
3030-2.46	2.46	12.30	14.50	3.00	38	■
3030-2.47	2.47	12.35	14.50	3.00	38	■
3030-2.48	2.48	12.40	14.50	3.00	38	■
3030-2.49	2.49	12.45	14.50	3.00	38	■
3030-2.50	2.50	12.50	14.50	3.00	38	■
3030-2.51	2.51	12.55	14.50	3.00	38	■
3030-2.52	2.52	12.60	14.50	3.00	38	■
3030-2.53	2.53	12.65	14.50	3.00	38	■

Art. N°	D1 h6	L2	L3	D2 h6	L1	N
3030-2.54	2.54	12.70	14.50	3.00	38	■
3030-2.55	2.55	12.75	14.50	3.00	38	■
3030-2.56	2.56	12.80	14.50	3.00	38	■
3030-2.57	2.57	12.85	14.50	3.00	38	■
3030-2.58	2.58	12.90	14.50	3.00	38	■
3030-2.59	2.59	12.95	14.50	3.00	38	■
3030-2.60	2.60	13.00	14.50	3.00	38	■
3030-2.61	2.61	13.05	14.50	3.00	38	■
3030-2.62	2.62	13.10	14.50	3.00	38	■
3030-2.63	2.63	13.15	14.50	3.00	38	■
3030-2.64	2.64	13.20	14.50	3.00	38	■
3030-2.65	2.65	13.25	14.50	3.00	38	■
3030-2.66	2.66	13.30	16.50	3.00	38	■
3030-2.67	2.67	13.35	16.50	3.00	38	■
3030-2.68	2.68	13.40	16.50	3.00	38	■
3030-2.69	2.69	13.45	16.50	3.00	38	■
3030-2.70	2.70	13.50	16.50	3.00	38	■
3030-2.71	2.71	13.55	16.55	3.00	38	■
3030-2.72	2.72	13.60	16.50	3.00	38	■
3030-2.73	2.73	13.65	16.50	3.00	38	■
3030-2.74	2.74	13.70	16.50	3.00	38	■
3030-2.75	2.75	13.75	16.50	3.00	38	■
3030-2.76	2.76	13.80	16.50	3.00	38	■
3030-2.77	2.77	13.85	16.50	3.00	38	■
3030-2.78	2.78	13.90	16.50	3.00	38	■
3030-2.79	2.79	13.95	16.50	3.00	38	■
3030-2.80	2.80	14.00	16.50	3.00	38	■
3030-2.81	2.81	14.05	16.50	3.00	38	■
3030-2.82	2.82	14.10	16.50	3.00	38	■
3030-2.83	2.83	14.15	16.50	3.00	38	■
3030-2.84	2.84	14.20	16.50	3.00	38	■
3030-2.85	2.85	14.25	16.50	3.00	38	■
3030-2.86	2.86	14.30	16.50	3.00	38	■
3030-2.87	2.87	14.35	16.50	3.00	38	■
3030-2.88	2.88	14.40	16.50	3.00	38	■
3030-2.89	2.89	14.45	16.50	3.00	38	■
3030-2.90	2.90	14.50	16.50	3.00	38	■
3030-2.91	2.91	14.55	16.50	3.00	38	■
3030-2.92	2.92	14.60	16.50	3.00	38	■
3030-2.93	2.93	14.65	16.50	3.00	38	■
3030-2.94	2.94	14.70	16.50	3.00	38	■
3030-2.95	2.95	14.75	16.50	3.00	38	■
3030-2.96	2.96	14.80	16.50	3.00	38	■
3030-2.97	2.97	14.85	16.50	3.00	38	■
3030-2.98	2.98	14.90	16.50	3.00	38	■
3030-2.99	2.99	14.95	16.50	3.00	38	■

4000



Rubrique	Type	Dents	Corps	Longueur de coupe	Angle d'hélice	Diamètre	Page	
Rubrik	Typ	Zähne	Schaft	Schnittlänge	Spiralwinkel	Durchmesser	Seite	
Section	Type	Teeth	Shank	Cutting length	Angle	Diameter	Page	
Paramètres								
Schnittwerte							3.02	
Data								
Micro-fraises Mikropräzisionsfräser Micro end mills	MD VHM HM	4170-2	Z1	Ø3h4	2x D1	0°	Ø0.20 - 3.00	3.03
		4170R-2	Z1	Ø3h4	2x D1	0°	Ø0.20 - 3.00	3.04
		 4170R-3	Z1	Ø3h4	3x D1	0°	Ø0.30 - 3.00	3.05
		 4170R-4	Z1	Ø3h4	4x D1	0°	Ø0.30 - 3.00	3.06
		4270-0.75	Z2	Ø3h4	0.75x D1	30°	Ø0.20 - 2.00	3.07
		4270-1.5	Z2	Ø3h4	1.5x D1	30°	Ø0.10 - 2.00	3.08
		 4270-2	Z2	Ø3h4	2x D1	30°	Ø0.10 - 2.00	3.09
		4270-3	Z2	Ø3h4	3x D1	30°	Ø0.10 - 2.90	3.10
		4270-5	Z2	Ø3h4	5x D1	30°	Ø0.30 - 2.50	3.11
		4270-8	Z2	Ø3h4	8x D1	30°	Ø0.40 - 2.50	3.12
		4370-1.3	Z3	Ø3h4	1.3x D1	30°	Ø0.30 - 2.90	3.13
		4370-2	Z3	Ø3h4	2x D1	30°	Ø0.30 - 2.90	3.14
		4370-3	Z3	Ø3h4	3x D1	30°	Ø0.30 - 2.90	3.15
		4370-4	Z3	Ø3h4	4x D1	30°	Ø0.30 - 2.90	3.16
		4370-5	Z3	Ø3h4	5x D1	30°	Ø0.50 - 2.50	3.17
		4370-8	Z3	Ø3h4	8x D1	30°	Ø0.50 - 2.50	3.18
		4375-2.5	Z3	Ø3h4	2.5x D1	45°	Ø0.30 - 2.90	3.19
		 DHD4370-1.5	Z3	Ø3h4	1.5x D1	36° - 38° - 40°	Ø0.30 - 2.50	3.20
		 DHD4370-3	Z3	Ø3h4	3x D1	36° - 38° - 40°	Ø0.30 - 2.50	3.21
		 4470-1.5	Z4	Ø3h4	1.5x D1	30°	Ø0.30 - 2.90	3.22
 4470-3	Z4	Ø3h4	3x D1	30°	Ø0.30 - 2.90	3.23		
4472-2	Z4	Ø3h4	2x D1	40°	Ø0.30 - 2.90	3.24		
4472-4	Z4	Ø3h4	4x D1	40°	Ø0.40 - 2.90	3.25		
 DHP4470-3	Z4	Ø3h4	3x D1	35°/38°	Ø0.50 - 2.50	3.26		
Micro-fraises hémisphériques	MD	4278-0.75	Z2	Ø3h4	0.75x D1	30°	Ø0.20 - 1.00	3.27
Mikropräzisionsfräser mit Radius	VHM	4278-1.5	Z2	Ø3h4	1.5x D1	30°	Ø0.20 - 2.50	3.28
Micro end mills with radius	HM	4278-3	Z2	Ø3h4	3x D1	30°	Ø0.20 - 2.90	3.29

Paramètres de coupe indicatifs
Empfohlene Schnittwerte
Standard machining data

Micro-fraises
Mikropräzisionsfräser
Micro end mills

Matière Werkstoff Material	Lubrifiant* Kühlung* Coolant*	Vc [m/min]	fz [mm] Ø 0.2 - 1.2	fz [mm] Ø 1.3 - 2.9
Acier inoxydable Rostfreier Stahl Stainless steel	O / E	30 - 70	0.001 - 0.008	0.004 - 0.020
Acier Stahl <700 N/mm ² Steel	O / E	30 - 90	0.002 - 0.010	0.005 - 0.018
Acier Stahl >700 N/mm ² Steel	O / E	25 - 60	0.001 - 0.007	0.002 - 0.012
Titane Titan Titanium	O / E	25 - 40	0.001 - 0.008	0.003 - 0.010
Aluminium	O / E	80 - 250	0.002 - 0.010	0.005 - 0.020
Cuivre Kupfer Copper	A / O / E	60 - 120	0.001 - 0.080	0.004 - 0.020
Laiton Messing Brass	A / O / E	80 - 180	0.002 - 0.012	0.006 - 0.025
Or Gold Gold	A / O / E	80 - 160	0.002 - 0.012	0.006 - 0.025

Avec revêtement, augmenter les valeurs de 20 %
Mit Beschichtung, Daten um 20 % erhöhen
With coating, increase data by 20 %

***O = huile de coupe / Schneidöl / cutting oil**
***E = emulsion**
***A = sec (air comprimé) / trocken (Druckluft) / dry (air)**

Micro-fraises
Mikropräzisionsfräser
Micro end mills

4170-2

SWISS  MADE

MD VHM HM	λ 0°	 Sharp Corner	 2xD1	Z = 1	
-----------------	--------------	---	--	-------	---

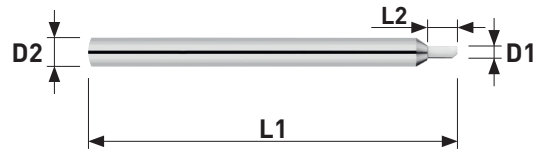

Art. N°	D1 +0.005 -0.010	L2	D2 h4	L1	N	TiAlN	TiCN	ALFA- TOP
4170-2-0.20	0.20	0.40	3.00	39	■			
4170-2-0.30	0.30	0.60	3.00	39	■	□	□	■
4170-2-0.40	0.40	0.80	3.00	39	■	□	□	■
4170-2-0.50	0.50	1.00	3.00	39	■	□	□	■
4170-2-0.60	0.60	1.20	3.00	39	■	□	□	■
4170-2-0.70	0.70	1.40	3.00	39	■	□	□	■
4170-2-0.80	0.80	1.60	3.00	39	■	□	□	■
4170-2-0.90	0.90	1.80	3.00	39	■	□	□	■
4170-2-1.00	1.00	2.00	3.00	39	■	□	□	■
4170-2-1.10	1.10	2.20	3.00	39	■	□	□	■
4170-2-1.20	1.20	2.40	3.00	39	■	□	□	■
4170-2-1.30	1.30	2.60	3.00	39	■	□	□	■
4170-2-1.40	1.40	2.80	3.00	39	■	□	□	■
4170-2-1.50	1.50	3.00	3.00	39	■	□	□	■
4170-2-1.60	1.60	3.20	3.00	39	■	□	□	■
4170-2-1.70	1.70	3.40	3.00	39	■	□	□	■
4170-2-1.80	1.80	3.60	3.00	39	■	□	□	■
4170-2-1.90	1.90	3.80	3.00	39	■	□	□	■
4170-2-2.00	2.00	4.00	3.00	39	■	□	□	■
4170-2-2.50	2.50	5.00	3.00	39	■	□	□	■
4170-2-3.00	3.00	6.00	4.00	40	■	□	□	■

Micro-fraises
Mikropräzisionsfräser
Micro end mills

4170R-2

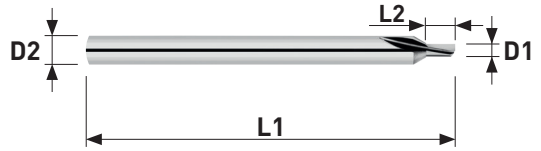

SWISS  MADE

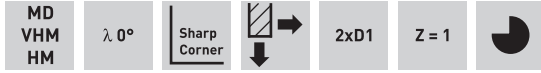

Art. N°	D1 +0.005 -0.010	L2	D2 ^{h4}	L1	N	TiAlN	TiCN	ALFA- TOP
4170R-2-0.20	0.20	0.40	3.00	39	■			■
4170R-2-0.30	0.30	0.60	3.00	39	■	□	□	■
4170R-2-0.40	0.40	0.80	3.00	39	■	□	□	■
4170R-2-0.50	0.50	1.00	3.00	39	■	□	□	■
4170R-2-0.60	0.60	1.20	3.00	39	■	□	□	■
4170R-2-0.70	0.70	1.40	3.00	39	■	□	□	■
4170R-2-0.80	0.80	1.60	3.00	39	■	□	□	■
4170R-2-0.90	0.90	1.80	3.00	39	■	□	□	■
4170R-2-1.00	1.00	2.00	3.00	39	■	□	□	■
4170R-2-1.10	1.10	2.20	3.00	39	■	□	□	■
4170R-2-1.20	1.20	2.40	3.00	39	■	□	□	■
4170R-2-1.30	1.30	2.60	3.00	39	■	□	□	■
4170R-2-1.40	1.40	2.80	3.00	39	■	□	□	■
4170R-2-1.50	1.50	3.00	3.00	39	■	□	□	■
4170R-2-1.60	1.60	3.20	3.00	39	■	□	□	■
4170R-2-1.70	1.70	3.40	3.00	39	■	□	□	■
4170R-2-1.80	1.80	3.60	3.00	39	■	□	□	■
4170R-2-1.90	1.90	3.80	3.00	39	■	□	□	■
4170R-2-2.00	2.00	4.00	3.00	39	■	□	□	■
4170R-2-2.10	2.10	4.10	3.00	39	■	□	□	■
4170R-2-2.20	2.20	4.40	3.00	39	■	□	□	■
4170R-2-2.30	2.30	4.60	3.00	39	■	□	□	■
4170R-2-2.40	2.40	4.80	3.00	39	■	□	□	■
4170R-2-2.50	2.50	5.00	3.00	39	■	□	□	■
4170R-2-2.60	2.60	5.20	3.00	39	■	□	□	■
4170R-2-2.70	2.70	5.40	3.00	39	■	□	□	■
4170R-2-2.80	2.80	5.60	3.00	39	■	□	□	■
4170R-2-2.90	2.90	5.80	3.00	39	■	□	□	■
4170R-2-3.00	3.00	6.00	4.00	40	■	□	□	■

Micro-fraises
Mikropräzisionsfräser
Micro end mills

4170R-3

SWISS  MADE



Art. N°	D1 +0.005 -0.010	L2	D2 h4	L1	N	TiAlN	TiCN	ALFA- TOP
4170R-3-0.30	0.30	0.90	3.00	39	■	□	□	■
4170R-3-0.40	0.40	1.20	3.00	39	■	□	□	■
4170R-3-0.50	0.50	1.50	3.00	39	■	□	□	■
4170R-3-0.60	0.60	1.80	3.00	39	■	□	□	■
4170R-3-0.70	0.70	2.10	3.00	39	■	□	□	■
4170R-3-0.80	0.80	2.40	3.00	39	■	□	□	■
4170R-3-0.90	0.90	2.70	3.00	39	■	□	□	■
4170R-3-1.00	1.00	3.00	3.00	39	■	□	□	■
4170R-3-1.10	1.10	3.30	3.00	39	■	□	□	■
4170R-3-1.20	1.20	3.60	3.00	39	■	□	□	■
4170R-3-1.30	1.30	3.90	3.00	39	■	□	□	■
4170R-3-1.40	1.40	4.20	3.00	39	■	□	□	■
4170R-3-1.50	1.50	4.50	3.00	39	■	□	□	■
4170R-3-2.00	2.00	6.00	3.00	39	■	□	□	■
4170R-3-2.50	2.50	7.50	3.00	39	■	□	□	■
4170R-3-3.00	3.00	9.00	4.00	40	■	□	□	■

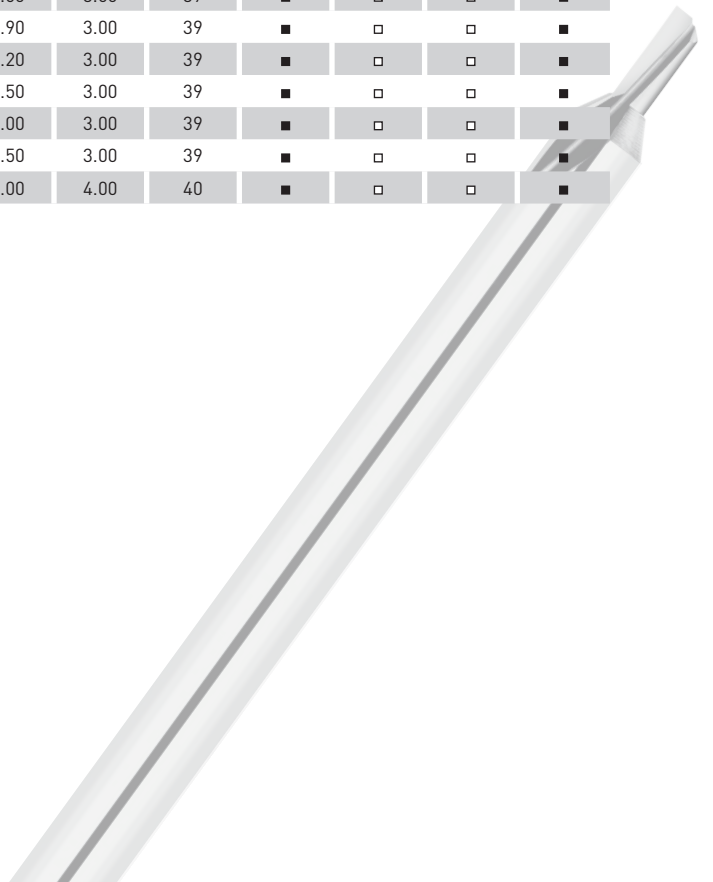

Micro-fraises
Mikropräzisionsfräser
Micro end mills

4170R-4



SWISS  MADE



Art. N°	D1 +0.005 -0.010	L2	D2 h4	L1	N	TiAlN	TiCN	ALFA- TOP
4170R-4-0.30	0.30	1.20	3.00	39	■	□	□	■
4170R-4-0.40	0.40	1.60	3.00	39	■	□	□	■
4170R-4-0.50	0.50	2.00	3.00	39	■	□	□	■
4170R-4-0.60	0.60	2.40	3.00	39	■	□	□	■
4170R-4-0.70	0.70	2.80	3.00	39	■	□	□	■
4170R-4-0.80	0.80	3.20	3.00	39	■	□	□	■
4170R-4-0.90	0.90	3.60	3.00	39	■	□	□	■
4170R-4-1.00	1.00	4.00	3.00	39	■	□	□	■
4170R-4-1.10	1.10	4.40	3.00	39	■	□	□	■
4170R-4-1.20	1.20	4.80	3.00	39	■	□	□	■
4170R-4-1.30	1.30	5.20	3.00	39	■	□	□	■
4170R-4-1.40	1.40	5.60	3.00	39	■	□	□	■
4170R-4-1.50	1.50	6.00	3.00	39	■	□	□	■
4170R-4-2.00	2.00	8.00	3.00	39	■	□	□	■
4170R-4-2.50	2.50	10.00	3.00	39	■	□	□	■
4170R-4-3.00	3.00	12.00	4.00	40	■	□	□	■

Micro-fraises
Mikropräzisionsfräser
Micro end mills

4270-0.75

SWISS  MADE

MD VHM HM	λ 30°	 Sharp Corner	 0.75xD1	Z = 2	
-----------------	---------------	---	---	-------	---

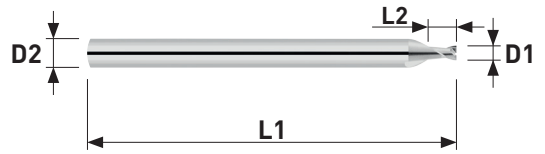

Art. N°	D1 +0.005 -0.010	L2	D2 h4	L1	N	TiAlN	TiCN	ALFA- TOP
4270-0.75-0.20	0.20	0.15	3.00	39	■			
4270-0.75-0.30	0.30	0.25	3.00	39	■	■	■	■
4270-0.75-0.40	0.40	0.30	3.00	39	■	■	■	■
4270-0.75-0.50	0.50	0.37	3.00	39	■	■	■	■
4270-0.75-0.60	0.60	0.45	3.00	39	■	■	■	■
4270-0.75-0.70	0.70	0.53	3.00	39	■	■	■	■
4270-0.75-0.80	0.80	0.60	3.00	39	■	■	■	■
4270-0.75-0.90	0.90	0.70	3.00	39	■	■	■	■
4270-0.75-1.00	1.00	0.75	3.00	39	■	■	■	■
4270-0.75-1.10	1.10	0.90	3.00	39	■	■	■	■
4270-0.75-1.20	1.20	0.90	3.00	39	■	■	■	■
4270-0.75-1.30	1.30	1.00	3.00	39	■	■	■	■
4270-0.75-1.40	1.40	1.10	3.00	39	■	■	■	■
4270-0.75-1.50	1.50	1.15	3.00	39	■	■	■	■
4270-0.75-1.60	1.60	1.20	3.00	39	■	■	■	■
4270-0.75-1.70	1.70	1.30	3.00	39	■	■	■	■
4270-0.75-1.80	1.80	1.40	3.00	39	■	■	■	■
4270-0.75-1.90	1.90	1.45	3.00	39	■	■	■	■
4270-0.75-2.00	2.00	1.50	3.00	39	■	■	■	■

Micro-fraises
Mikropräzisionsfräser
Micro end mills

4270-1.5



SWISS  MADE



Art. N°	D1 +0.005 -0.010	L2	D2 h4	L1	N	TiAlN	TiCN	ALFA- TOP
4270-1.5-0.10	0.10	0.15	3.00	39	■			
4270-1.5-0.15	0.15	0.20	3.00	39	■			
4270-1.5-0.20	0.20	0.30	3.00	39	■			
4270-1.5-0.25	0.25	0.35	3.00	39	■			
4270-1.5-0.30	0.30	0.45	3.00	39	■	■	■	■
4270-1.5-0.40	0.40	0.60	3.00	39	■	■	■	■
4270-1.5-0.50	0.50	0.75	3.00	39	■	■	■	■
4270-1.5-0.60	0.60	0.90	3.00	39	■	■	■	■
4270-1.5-0.70	0.70	1.05	3.00	39	■	■	■	■
4270-1.5-0.80	0.80	1.20	3.00	39	■	■	■	■
4270-1.5-0.90	0.90	1.35	3.00	39	■	■	■	■
4270-1.5-1.00	1.00	1.50	3.00	39	■	■	■	■
4270-1.5-1.10	1.10	1.65	3.00	39	■	■	■	■
4270-1.5-1.20	1.20	1.80	3.00	39	■	■	■	■
4270-1.5-1.30	1.30	1.95	3.00	39	■	■	■	■
4270-1.5-1.40	1.40	2.10	3.00	39	■	■	■	■
4270-1.5-1.50	1.50	2.25	3.00	39	■	■	■	■
4270-1.5-1.60	1.60	2.40	3.00	39	■	■	■	■
4270-1.5-1.70	1.70	2.55	3.00	39	■	■	■	■
4270-1.5-1.80	1.80	2.70	3.00	39	■	■	■	■
4270-1.5-1.90	1.90	2.85	3.00	39	■	■	■	■
4270-1.5-2.00	2.00	3.00	3.00	39	■	■	■	■

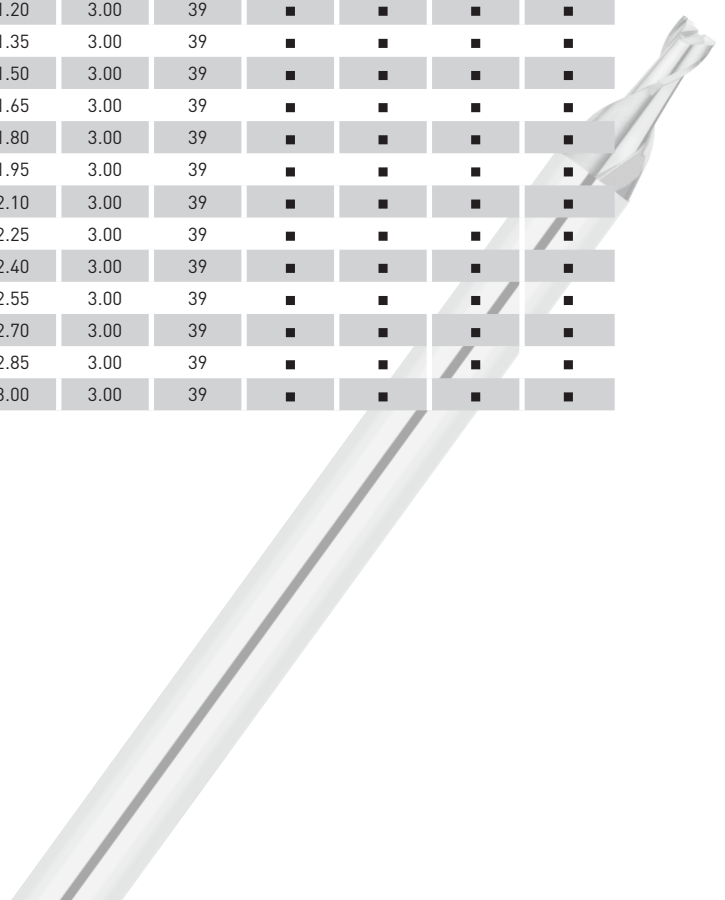

Micro-fraises
Mikropräzisionsfräser
Micro end mills

4270-2

SWISS  MADE

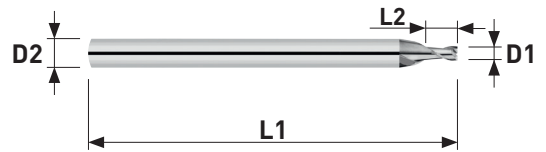

Art. N°	D1 +0.005 -0.010	L2	D2 h4	L1	N	TiAlN	TiCN	ALFA- TOP
4270-2-0.10	0.10	0.20	3.00	39	■			
4270-2-0.15	0.15	0.30	3.00	39	■			
4270-2-0.20	0.20	0.40	3.00	39	■			
4270-2-0.25	0.25	0.50	3.00	39	■			
4270-2-0.30	0.30	0.60	3.00	39	■	■	■	■
4270-2-0.40	0.40	0.80	3.00	39	■	■	■	■
4270-2-0.50	0.50	1.00	3.00	39	■	■	■	■
4270-2-0.60	0.60	1.20	3.00	39	■	■	■	■
4270-2-0.70	0.70	1.40	3.00	39	■	■	■	■
4270-2-0.80	0.80	1.60	3.00	39	■	■	■	■
4270-2-0.90	0.90	1.80	3.00	39	■	■	■	■
4270-2-1.00	1.00	2.00	3.00	39	■	■	■	■
4270-2-1.10	1.10	2.20	3.00	39	■	■	■	■
4270-2-1.20	1.20	2.40	3.00	39	■	■	■	■
4270-2-1.30	1.30	2.60	3.00	39	■	■	■	■
4270-2-1.40	1.40	2.80	3.00	39	■	■	■	■
4270-2-1.50	1.50	3.00	3.00	39	■	■	■	■
4270-2-1.60	1.60	3.20	3.00	39	■	■	■	■
4270-2-1.70	1.70	3.40	3.00	39	■	■	■	■
4270-2-1.80	1.80	3.60	3.00	39	■	■	■	■
4270-2-1.90	1.90	3.80	3.00	39	■	■	■	■
4270-2-2.00	2.00	4.00	3.00	39	■	■	■	■

Micro-fraises
Mikropräzisionsfräser
Micro end mills

4270-3

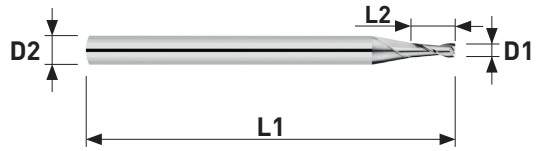

SWISS  MADE

MD VHM HM	λ 30°	Sharp Corner		3xD1	Z = 2	
-----------------	---------------	-----------------	---	------	-------	---

Art. N°	D1 +0.005 -0.010	L2	D2 h4	L1	N	TiAlN	TiCN	ALFA- TOP
4270-3-0.10	0.10	0.25	3.00	39	■			
4270-3-0.15	0.15	0.30	3.00	39	■			
4270-3-0.20	0.20	0.50	3.00	39	■			
4270-3-0.25	0.25	0.50	3.00	39	■			
4270-3-0.30	0.30	1.00	3.00	39	■	■	■	■
4270-3-0.40	0.40	1.20	3.00	39	■	■	■	■
4270-3-0.50	0.50	1.50	3.00	39	■	■	■	■
4270-3-0.60	0.60	2.00	3.00	39	■	■	■	■
4270-3-0.70	0.70	2.00	3.00	39	■	■	■	■
4270-3-0.75	0.75	2.00	3.00	39	■	■	■	■
4270-3-0.80	0.80	2.50	3.00	39	■	■	■	■
4270-3-0.90	0.90	2.50	3.00	39	■	■	■	■
4270-3-1.00	1.00	3.00	3.00	39	■	■	■	■
4270-3-1.10	1.10	3.00	3.00	39	■	■	■	■
4270-3-1.20	1.20	4.00	3.00	39	■	■	■	■
4270-3-1.30	1.30	4.00	3.00	39	■	■	■	■
4270-3-1.40	1.40	4.00	3.00	39	■	■	■	■
4270-3-1.50	1.50	4.50	3.00	39	■	■	■	■
4270-3-1.60	1.60	4.50	3.00	39	■	■	■	■
4270-3-1.70	1.70	5.00	3.00	39	■	■	■	■
4270-3-1.80	1.80	6.00	3.00	39	■	■	■	■
4270-3-1.90	1.90	6.00	3.00	39	■	■	■	■
4270-3-2.00	2.00	6.00	3.00	39	■	■	■	■
4270-3-2.10	2.10	6.00	3.00	39	■	■	■	■
4270-3-2.20	2.20	6.50	3.00	39	■	■	■	■
4270-3-2.30	2.30	7.00	3.00	39	■	■	■	■
4270-3-2.40	2.40	7.00	3.00	39	■	■	■	■
4270-3-2.50	2.50	7.50	3.00	39	■	■	■	■
4270-3-2.60	2.60	7.50	3.00	39	■	■	■	■
4270-3-2.70	2.70	8.00	3.00	39	■	■	■	■
4270-3-2.80	2.80	8.00	3.00	39	■	■	■	■
4270-3-2.90	2.90	8.00	3.00	39	■	■	■	■

Micro-fraises
Mikropräzisionsfräser
Micro end mills

4270-5

SWISS  MADE

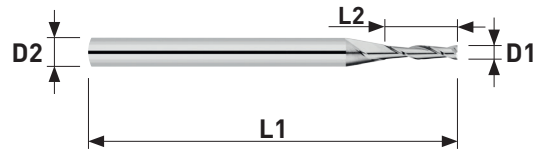

Art. N°	D1 +0.005 -0.010	L2	D2 h4	L1	N	TiAlN	TiCN	ALFA- TOP
4270-5-0.30	0.30	1.50	3.00	39	■	■	■	■
4270-5-0.40	0.40	2.00	3.00	39	■	■	■	■
4270-5-0.50	0.50	2.50	3.00	39	■	■	■	■
4270-5-0.60	0.60	3.00	3.00	39	■	■	■	■
4270-5-0.70	0.70	3.50	3.00	39	■	■	■	■
4270-5-0.80	0.80	4.00	3.00	39	■	■	■	■
4270-5-0.90	0.90	4.50	3.00	39	■	■	■	■
4270-5-1.00	1.00	5.00	3.00	39	■	■	■	■
4270-5-1.10	1.10	5.50	3.00	39	■	■	■	■
4270-5-1.20	1.20	6.00	3.00	39	■	■	■	■
4270-5-1.50	1.50	7.50	3.00	39	■	■	■	■
4270-5-2.00	2.00	10.00	3.00	39	■	■	■	■
4270-5-2.50	2.50	12.50	3.00	39	■	■	■	■

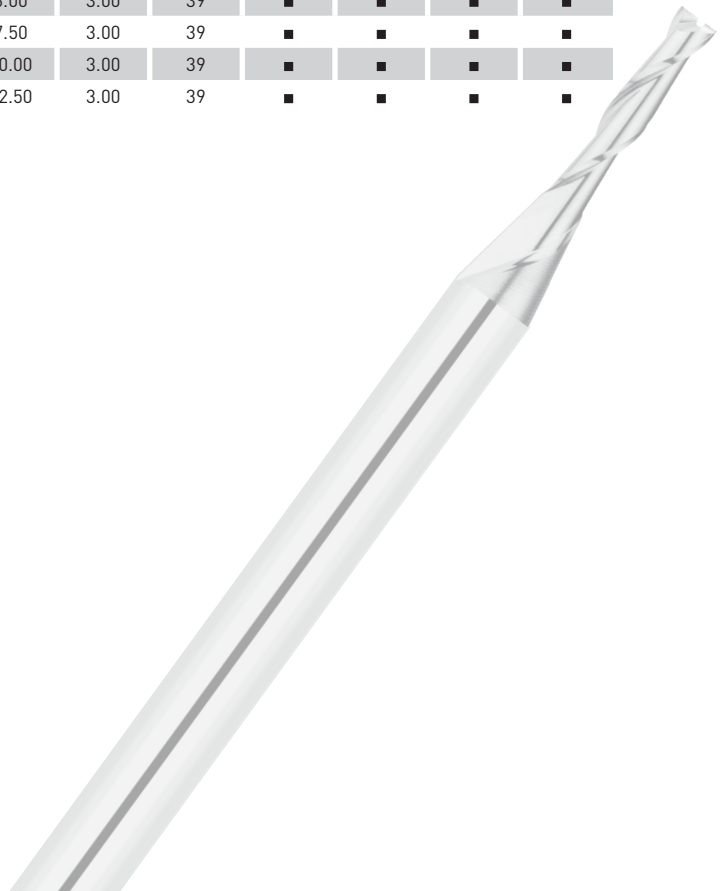

Micro-fraises
Mikropräzisionsfräser
Micro end mills

4270-8

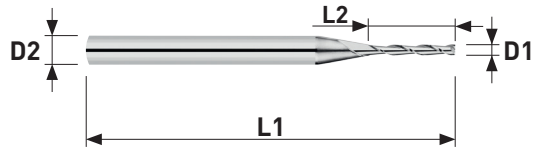

SWISS  MADE



Art. N°	D1 +0.005 -0.010	L2	D2 _{h4}	L1	N	TiAlN	TiCN	ALFA- TOP
4270-8-0.40	0.40	3.20	3.00	39	■	■	■	■
4270-8-0.50	0.50	4.00	3.00	39	■	■	■	■
4270-8-0.60	0.60	5.00	3.00	39	■	■	■	■
4270-8-0.70	0.70	5.60	3.00	39	■	■	■	■
4270-8-0.80	0.80	6.00	3.00	39	■	■	■	■
4270-8-0.90	0.90	7.20	3.00	39	■	■	■	■
4270-8-1.00	1.00	8.00	3.00	39	■	■	■	■
4270-8-1.20	1.20	9.00	3.00	39	■	■	■	■
4270-8-1.50	1.50	12.00	4.00	50	■	■	■	■
4270-8-2.00	2.00	16.00	4.00	50	■	■	■	■
4270-8-2.50	2.50	20.00	4.00	50	■	■	■	■



Micro-fraises
Mikropräzisionsfräser
Micro end mills

4370-1.3

SWISS  MADE

MD VHM HM	λ 30°	Sharp Corner		1.3xD1	Z = 3	
-----------------	---------------	-----------------	---	--------	-------	---

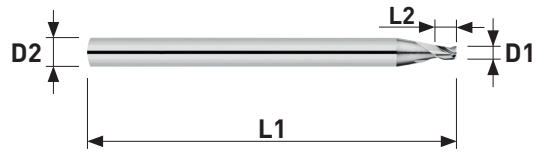

Art. N°	D1 +0.005 -0.010	L2	D2 h4	L1	N	TiAlN	TiCN	ALFA- TOP
4370-1.3-0.30	0.30	0.40	3.00	39	■	■	■	■
4370-1.3-0.40	0.40	0.50	3.00	39	■	■	■	■
4370-1.3-0.45	0.45	0.60	3.00	39	■	■	■	■
4370-1.3-0.50	0.50	0.70	3.00	39	■	■	■	■
4370-1.3-0.60	0.60	0.80	3.00	39	■	■	■	■
4370-1.3-0.70	0.70	0.90	3.00	39	■	■	■	■
4370-1.3-0.80	0.80	1.00	3.00	39	■	■	■	■
4370-1.3-0.90	0.90	1.30	3.00	39	■	■	■	■
4370-1.3-1.00	1.00	1.30	3.00	39	■	■	■	■
4370-1.3-1.10	1.10	1.50	3.00	39	■	■	■	■
4370-1.3-1.20	1.20	1.60	3.00	39	■	■	■	■
4370-1.3-1.30	1.30	1.80	3.00	39	■	■	■	■
4370-1.3-1.40	1.40	1.80	3.00	39	■	■	■	■
4370-1.3-1.50	1.50	2.00	3.00	39	■	■	■	■
4370-1.3-1.60	1.60	2.00	3.00	39	■	■	■	■
4370-1.3-1.70	1.70	2.00	3.00	39	■	■	■	■
4370-1.3-1.80	1.80	2.40	3.00	39	■	■	■	■
4370-1.3-1.90	1.90	2.40	3.00	39	■	■	■	■
4370-1.3-2.00	2.00	2.60	3.00	39	■	■	■	■
4370-1.3-2.20	2.20	3.00	3.00	39	■	■	■	■
4370-1.3-2.50	2.50	3.30	3.00	39	■	■	■	■
4370-1.3-2.80	2.80	3.50	3.00	39	■	■	■	■
4370-1.3-2.90	2.90	3.50	3.00	39	■	■	■	■

Micro-fraises
Mikropräzisionsfräser
Micro end mills

4370-2

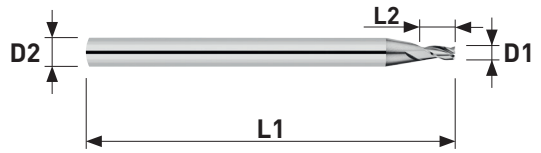

SWISS  MADE



Art. N°	D1 +0.005 -0.010	L2	D2 h4	L1	N	TiAlN	TiCN	ALFA- TOP
4370-2-0.30	0.30	0.60	3.00	39	■	■	■	■
4370-2-0.40	0.40	0.80	3.00	39	■	■	■	■
4370-2-0.50	0.50	1.00	3.00	39	■	■	■	■
4370-2-0.60	0.60	1.20	3.00	39	■	■	■	■
4370-2-0.70	0.70	1.40	3.00	39	■	■	■	■
4370-2-0.75	0.75	1.50	3.00	39	■	■	■	■
4370-2-0.80	0.80	1.60	3.00	39	■	■	■	■
4370-2-0.90	0.90	1.80	3.00	39	■	■	■	■
4370-2-1.00	1.00	2.00	3.00	39	■	■	■	■
4370-2-1.10	1.10	2.20	3.00	39	■	■	■	■
4370-2-1.20	1.20	2.40	3.00	39	■	■	■	■
4370-2-1.30	1.30	2.60	3.00	39	■	■	■	■
4370-2-1.40	1.40	2.80	3.00	39	■	■	■	■
4370-2-1.50	1.50	3.00	3.00	39	■	■	■	■
4370-2-1.60	1.60	3.20	3.00	39	■	■	■	■
4370-2-1.70	1.70	3.40	3.00	39	■	■	■	■
4370-2-1.80	1.80	3.60	3.00	39	■	■	■	■
4370-2-1.90	1.90	3.80	3.00	39	■	■	■	■
4370-2-2.00	2.00	4.00	3.00	39	■	■	■	■
4370-2-2.10	2.10	4.20	3.00	39	■	■	■	■
4370-2-2.20	2.20	4.40	3.00	39	■	■	■	■
4370-2-2.30	2.30	4.60	3.00	39	■	■	■	■
4370-2-2.40	2.40	4.80	3.00	39	■	■	■	■
4370-2-2.50	2.50	5.00	3.00	39	■	■	■	■
4370-2-2.60	2.60	5.20	3.00	39	■	■	■	■
4370-2-2.70	2.70	5.40	3.00	39	■	■	■	■
4370-2-2.80	2.80	5.60	3.00	39	■	■	■	■
4370-2-2.90	2.90	5.80	3.00	39	■	■	■	■

Micro-fraises
Mikropräzisionsfräser
Micro end mills

4370-3

SWISS  MADE

MD VHM HM	λ 30°	 Sharp Corner	 3xD1	Z = 3	
-----------------	---------------	---	--	-------	---

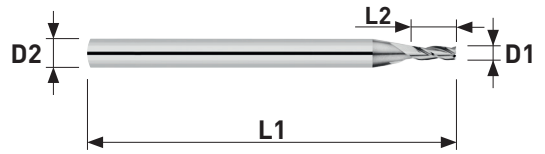

Art. N°	D1 +0.005 -0.010	L2	D2 h4	L1	N	TiAlN	TiCN	ALFA- TOP
4370-3-0.30	0.30	0.90	3.00	39	■	■	■	■
4370-3-0.40	0.40	1.20	3.00	39	■	■	■	■
4370-3-0.50	0.50	1.50	3.00	39	■	■	■	■
4370-3-0.60	0.60	2.00	3.00	39	■	■	■	■
4370-3-0.70	0.70	2.00	3.00	39	■	■	■	■
4370-3-0.75	0.75	2.00	3.00	39	■	■	■	■
4370-3-0.80	0.80	2.50	3.00	39	■	■	■	■
4370-3-0.90	0.90	2.50	3.00	39	■	■	■	■
4370-3-1.00	1.00	3.00	3.00	39	■	■	■	■
4370-3-1.10	1.10	3.30	3.00	39	■	■	■	■
4370-3-1.20	1.20	4.00	3.00	39	■	■	■	■
4370-3-1.30	1.30	4.00	3.00	39	■	■	■	■
4370-3-1.40	1.40	4.00	3.00	39	■	■	■	■
4370-3-1.50	1.50	4.50	3.00	39	■	■	■	■
4370-3-1.60	1.60	4.50	3.00	39	■	■	■	■
4370-3-1.70	1.70	5.00	3.00	39	■	■	■	■
4370-3-1.80	1.80	6.00	3.00	39	■	■	■	■
4370-3-1.90	1.90	6.00	3.00	39	■	■	■	■
4370-3-2.00	2.00	6.00	3.00	39	■	■	■	■
4370-3-2.10	2.10	6.00	3.00	39	■	■	■	■
4370-3-2.20	2.20	6.50	3.00	39	■	■	■	■
4370-3-2.30	2.30	7.00	3.00	39	■	■	■	■
4370-3-2.40	2.40	7.00	3.00	39	■	■	■	■
4370-3-2.50	2.50	7.50	3.00	39	■	■	■	■
4370-3-2.60	2.60	7.50	3.00	39	■	■	■	■
4370-3-2.70	2.70	8.00	3.00	39	■	■	■	■
4370-3-2.80	2.80	8.00	3.00	39	■	■	■	■
4370-3-2.90	2.90	8.50	3.00	39	■	■	■	■

Micro-fraises
Mikropräzisionsfräser
Micro end mills

4370-4

SWISS  MADE

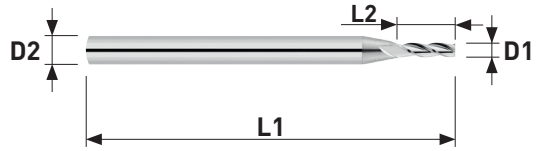

Art. N°	D1 +0.005 -0.010	L2	D2 h4	L1	N	TiAlN	TiCN	ALFA-TOP
4370-4-0.30	0.30	1.20	3.00	39	■	■	■	■
4370-4-0.40	0.40	1.60	3.00	39	■	■	■	■
4370-4-0.50	0.50	2.00	3.00	39	■	■	■	■
4370-4-0.60	0.60	2.40	3.00	39	■	■	■	■
4370-4-0.70	0.70	2.80	3.00	39	■	■	■	■
4370-4-0.80	0.80	3.20	3.00	39	■	■	■	■
4370-4-0.90	0.90	3.60	3.00	39	■	■	■	■
4370-4-1.00	1.00	4.00	3.00	39	■	■	■	■
4370-4-1.10	1.10	4.40	3.00	39	■	■	■	■
4370-4-1.20	1.20	4.80	3.00	39	■	■	■	■
4370-4-1.30	1.30	5.20	3.00	39	■	■	■	■
4370-4-1.40	1.40	5.60	3.00	39	■	■	■	■
4370-4-1.50	1.50	6.00	3.00	39	■	■	■	■
4370-4-1.60	1.60	6.40	3.00	39	■	■	■	■
4370-4-1.70	1.70	6.80	3.00	39	■	■	■	■
4370-4-1.80	1.80	7.20	3.00	39	■	■	■	■
4370-4-1.90	1.90	7.60	3.00	39	■	■	■	■
4370-4-2.00	2.00	8.00	3.00	39	■	■	■	■
4370-4-2.10	2.10	8.40	3.00	39	■	■	■	■
4370-4-2.20	2.20	8.80	3.00	39	■	■	■	■
4370-4-2.30	2.30	9.20	3.00	39	■	■	■	■
4370-4-2.40	2.40	9.60	3.00	39	■	■	■	■
4370-4-2.50	2.50	10.00	3.00	39	■	■	■	■
4370-4-2.60	2.60	10.40	3.00	39	■	■	■	■
4370-4-2.70	2.70	10.80	3.00	39	■	■	■	■
4370-4-2.80	2.80	11.20	3.00	39	■	■	■	■
4370-4-2.90	2.90	11.60	3.00	39	■	■	■	■

Micro-fraises
Mikropräzisionsfräser
Micro end mills

4370-5

SWISS  MADE

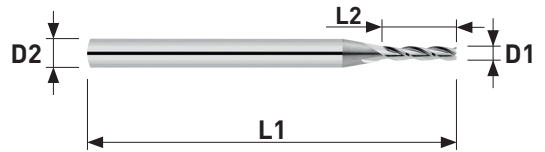

Art. N°	D1 +0.005 -0.010	L2	D2 h4	L1	N	TiAlN	TiCN	ALFA- TOP
4370-5-0.50	0.50	2.50	3.00	39	■	■	■	■
4370-5-0.60	0.60	3.00	3.00	39	■	■	■	■
4370-5-0.70	0.70	3.50	3.00	39	■	■	■	■
4370-5-0.80	0.80	4.00	3.00	39	■	■	■	■
4370-5-0.90	0.90	4.50	3.00	39	■	■	■	■
4370-5-1.00	1.00	5.00	3.00	39	■	■	■	■
4370-5-1.10	1.10	5.50	3.00	39	■	■	■	■
4370-5-1.20	1.20	6.00	3.00	39	■	■	■	■
4370-5-1.50	1.50	7.50	3.00	39	■	■	■	■
4370-5-2.00	2.00	10.00	3.00	39	■	■	■	■
4370-5-2.50	2.50	12.50	3.00	39	■	■	■	■



Micro-fraises
Mikropräzisionsfräser
Micro end mills

4370-8

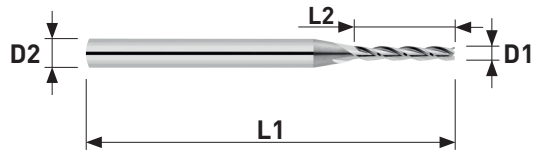

SWISS  MADE



Art. N°	D1 +0.005 -0.010	L2	D2 h4	L1	N	TiAlN	TiCN	ALFA-TOP
4370-8-0.50	0.50	4.00	3.00	39	■	■	■	■
4370-8-0.60	0.60	5.00	3.00	39	■	■	■	■
4370-8-0.70	0.70	5.60	3.00	39	■	■	■	■
4370-8-0.80	0.80	6.00	3.00	39	■	■	■	■
4370-8-0.90	0.90	7.20	3.00	39	■	■	■	■
4370-8-1.00	1.00	8.00	3.00	39	■	■	■	■
4370-8-1.20	1.20	9.00	3.00	39	■	■	■	■
4370-8-1.50	1.50	12.00	4.00	50	■	■	■	■
4370-8-2.00	2.00	16.00	4.00	50	■	■	■	■
4370-8-2.50	2.50	20.00	4.00	50	■	■	■	■



Micro-fraises
Mikropräzisionsfräser
Micro end mills

4375-2.5

SWISS  MADE

MD VHM HM	λ 45°	 Sharp Corner	 2.5xD1	Z = 3	
-----------------	---------------	---	--	-------	---



Art. N°	D1 +0.005 -0.010	L2	D2 h4	L1	N	TiAlN	TiCN	ALFA- TOP
4375-2.5-0.30	0.30	0.80	3.00	39	■	■	■	■
4375-2.5-0.40	0.40	1.00	3.00	39	■	■	■	■
4375-2.5-0.50	0.50	1.30	3.00	39	■	■	■	■
4375-2.5-0.60	0.60	1.50	3.00	39	■	■	■	■
4375-2.5-0.70	0.70	1.70	3.00	39	■	■	■	■
4375-2.5-0.80	0.80	2.00	3.00	39	■	■	■	■
4375-2.5-0.90	0.90	2.30	3.00	39	■	■	■	■
4375-2.5-1.00	1.00	2.50	3.00	39	■	■	■	■
4375-2.5-1.10	1.10	2.80	3.00	39	■	■	■	■
4375-2.5-1.20	1.20	3.00	3.00	39	■	■	■	■
4375-2.5-1.30	1.30	3.30	3.00	39	■	■	■	■
4375-2.5-1.40	1.40	3.50	3.00	39	■	■	■	■
4375-2.5-1.50	1.50	3.80	3.00	39	■	■	■	■
4375-2.5-1.60	1.60	4.00	3.00	39	■	■	■	■
4375-2.5-1.70	1.70	4.30	3.00	39	■	■	■	■
4375-2.5-1.80	1.80	4.50	3.00	39	■	■	■	■
4375-2.5-1.90	1.90	4.80	3.00	39	■	■	■	■
4375-2.5-2.00	2.00	5.00	3.00	39	■	■	■	■
4375-2.5-2.10	2.10	5.30	3.00	39	■	■	■	■
4375-2.5-2.20	2.20	5.50	3.00	39	■	■	■	■
4375-2.5-2.30	2.30	5.80	3.00	39	■	■	■	■
4375-2.5-2.40	2.40	6.00	3.00	39	■	■	■	■
4375-2.5-2.50	2.50	6.30	3.00	39	■	■	■	■
4375-2.5-2.60	2.60	6.50	3.00	39	■	■	■	■
4375-2.5-2.70	2.70	6.80	3.00	39	■	■	■	■
4375-2.5-2.80	2.80	7.00	3.00	39	■	■	■	■
4375-2.5-2.90	2.90	7.30	3.00	39	■	■	■	■

Micro-fraises
Mikropräzisionsfräser
Micro end mills

DHD4370-1.5

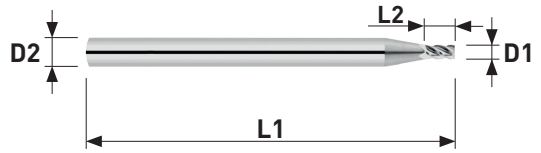

SWISS  MADE

MD	λ 36°			1.5xD1	Z = 3	
VHM	λ 38°					
HM	λ 40°					



Art. N°	D1 +0.005 -0.010	L2	D2 h ₄	L1	N	TiAlN	TiCN	ALFA- TOP
DHD4370-1.5-0.30	0.30	0.45	3.00	39	■			
DHD4370-1.5-0.40	0.40	0.60	3.00	39	■			
DHD4370-1.5-0.50	0.50	0.75	3.00	39	■	■	■	■
DHD4370-1.5-0.60	0.60	0.90	3.00	39	■	■	■	■
DHD4370-1.5-0.70	0.70	1.05	3.00	39	■	■	■	■
DHD4370-1.5-0.80	0.80	1.20	3.00	39	■	■	■	■
DHD4370-1.5-0.90	0.90	1.35	3.00	39	■	■	■	■
DHD4370-1.5-1.00	1.00	1.50	3.00	39	■	■	■	■
DHD4370-1.5-1.10	1.10	1.65	3.00	39	■	■	■	■
DHD4370-1.5-1.20	1.20	1.80	3.00	39	■	■	■	■
DHD4370-1.5-1.30	1.30	1.95	3.00	39	■	■	■	■
DHD4370-1.5-1.40	1.40	2.10	3.00	39	■	■	■	■
DHD4370-1.5-1.50	1.50	2.25	3.00	39	■	■	■	■
DHD4370-1.5-1.60	1.60	2.40	3.00	39	■	■	■	■
DHD4370-1.5-1.70	1.70	2.55	3.00	39	■	■	■	■
DHD4370-1.5-1.80	1.80	2.70	3.00	39	■	■	■	■
DHD4370-1.5-1.90	1.90	2.85	3.00	39	■	■	■	■
DHD4370-1.5-2.00	2.00	3.00	3.00	39	■	■	■	■
DHD4370-1.5-2.50	2.50	3.75	3.00	39	■	■	■	■

Micro-fraises
Mikropräzisionsfräser
Micro end mills

DHD4370-3

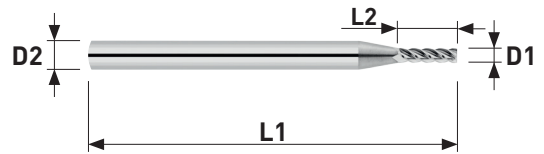

SWISS  MADE

MD	λ 36°			3xD1	Z = 3	
VHM	λ 38°					
HM	λ 40°					



Art. N°	D1 +0.005 -0.010	L2	D2 h4	L1	N	TiAlN	TiCN	ALFA- TOP
DHD4370-3-0.30	0.30	0.90	3.00	39	■			
DHD4370-3-0.40	0.40	1.20	3.00	39	■			
DHD4370-3-0.50	0.50	1.50	3.00	39	■	■	■	■
DHD4370-3-0.60	0.60	1.80	3.00	39	■	■	■	■
DHD4370-3-0.70	0.70	2.10	3.00	39	■	■	■	■
DHD4370-3-0.80	0.80	2.40	3.00	39	■	■	■	■
DHD4370-3-0.90	0.90	2.70	3.00	39	■	■	■	■
DHD4370-3-1.00	1.00	3.00	3.00	39	■	■	■	■
DHD4370-3-1.10	1.10	3.30	3.00	39	■	■	■	■
DHD4370-3-1.20	1.20	3.60	3.00	39	■	■	■	■
DHD4370-3-1.30	1.30	3.90	3.00	39	■	■	■	■
DHD4370-3-1.40	1.40	4.20	3.00	39	■	■	■	■
DHD4370-3-1.50	1.50	4.50	3.00	39	■	■	■	■
DHD4370-3-1.60	1.60	4.80	3.00	39	■	■	■	■
DHD4370-3-1.70	1.70	5.10	3.00	39	■	■	■	■
DHD4370-3-1.80	1.80	5.40	3.00	39	■	■	■	■
DHD4370-3-1.90	1.90	5.70	3.00	39	■	■	■	■
DHD4370-3-2.00	2.00	6.00	3.00	39	■	■	■	■
DHD4370-3-2.50	2.50	7.50	3.00	39	■	■	■	■

Micro-fraises
Mikropräzisionsfräser
Micro end mills

4470-1.5

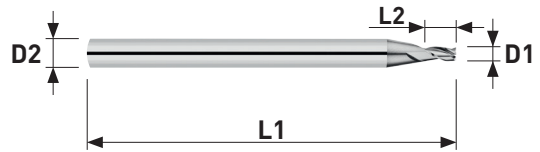

SWISS  MADE



Art. N°	D1 +0.005 -0.010	L2	D2 h4	L1	N	TiAlN	TiCN	ALFA- TOP
4470-1.5-0.30	0.30	0.45	3.00	39	■	■	■	■
4470-1.5-0.40	0.40	0.60	3.00	39	■	■	■	■
4470-1.5-0.50	0.50	0.75	3.00	39	■	■	■	■
4470-1.5-0.60	0.60	0.90	3.00	39	■	■	■	■
4470-1.5-0.70	0.70	1.05	3.00	39	■	■	■	■
4470-1.5-0.80	0.80	1.20	3.00	39	■	■	■	■
4470-1.5-0.90	0.90	1.35	3.00	39	■	■	■	■
4470-1.5-1.00	1.00	1.50	3.00	39	■	■	■	■
4470-1.5-1.10	1.10	1.65	3.00	39	■	■	■	■
4470-1.5-1.20	1.20	1.80	3.00	39	■	■	■	■
4470-1.5-1.30	1.30	1.95	3.00	39	■	■	■	■
4470-1.5-1.40	1.40	2.10	3.00	39	■	■	■	■
4470-1.5-1.50	1.50	2.25	3.00	39	■	■	■	■
4470-1.5-1.60	1.60	2.40	3.00	39	■	■	■	■
4470-1.5-1.70	1.70	2.55	3.00	39	■	■	■	■
4470-1.5-1.80	1.80	2.70	3.00	39	■	■	■	■
4470-1.5-1.90	1.90	2.85	3.00	39	■	■	■	■
4470-1.5-2.00	2.00	3.00	3.00	39	■	■	■	■
4470-1.5-2.10	2.10	3.15	3.00	39	■	■	■	■
4470-1.5-2.20	2.20	3.30	3.00	39	■	■	■	■
4470-1.5-2.30	2.30	3.45	3.00	39	■	■	■	■
4470-1.5-2.40	2.40	3.60	3.00	39	■	■	■	■
4470-1.5-2.50	2.50	3.75	3.00	39	■	■	■	■
4470-1.5-2.60	2.60	3.90	3.00	39	■	■	■	■
4470-1.5-2.70	2.70	4.05	3.00	39	■	■	■	■
4470-1.5-2.80	2.80	4.20	3.00	39	■	■	■	■
4470-1.5-2.90	2.90	4.35	3.00	39	■	■	■	■

Micro-fraises
Mikropräzisionsfräser
Micro end mills

4470-3

SWISS  MADE

MD VHM HM	λ 30°	Sharp Corner		3xD1	Z = 4	
-----------------	---------------	-----------------	---	------	-------	---

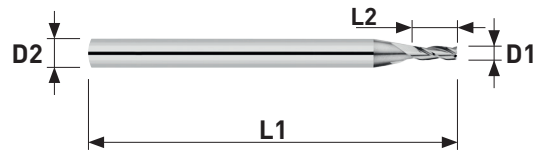

Art. N°	D1 +0.005 -0.010	L2	D2 h4	L1	N	TiAlN	TiCN	ALFA- TOP
4470-3-0.30	0.30	0.90	3.00	39	■	■	■	■
4470-3-0.40	0.40	1.20	3.00	39	■	■	■	■
4470-3-0.50	0.50	1.50	3.00	39	■	■	■	■
4470-3-0.60	0.60	1.80	3.00	39	■	■	■	■
4470-3-0.70	0.70	2.10	3.00	39	■	■	■	■
4470-3-0.80	0.80	2.40	3.00	39	■	■	■	■
4470-3-0.90	0.90	2.70	3.00	39	■	■	■	■
4470-3-1.00	1.00	3.00	3.00	39	■	■	■	■
4470-3-1.10	1.10	3.30	3.00	39	■	■	■	■
4470-3-1.20	1.20	3.60	3.00	39	■	■	■	■
4470-3-1.30	1.30	3.90	3.00	39	■	■	■	■
4470-3-1.40	1.40	4.20	3.00	39	■	■	■	■
4470-3-1.50	1.50	4.50	3.00	39	■	■	■	■
4470-3-1.60	1.60	4.80	3.00	39	■	■	■	■
4470-3-1.70	1.70	5.10	3.00	39	■	■	■	■
4470-3-1.80	1.80	5.40	3.00	39	■	■	■	■
4470-3-1.90	1.90	5.70	3.00	39	■	■	■	■
4470-3-2.00	2.00	6.00	3.00	39	■	■	■	■
4470-3-2.10	2.10	6.30	3.00	39	■	■	■	■
4470-3-2.20	2.20	6.60	3.00	39	■	■	■	■
4470-3-2.30	2.30	6.90	3.00	39	■	■	■	■
4470-3-2.40	2.40	7.20	3.00	39	■	■	■	■
4470-3-2.50	2.50	7.50	3.00	39	■	■	■	■
4470-3-2.60	2.60	7.80	3.00	39	■	■	■	■
4470-3-2.70	2.70	8.10	3.00	39	■	■	■	■
4470-3-2.80	2.80	8.40	3.00	39	■	■	■	■
4470-3-2.90	2.90	8.70	3.00	39	■	■	■	■

Micro-fraises
Mikropräzisionsfräser
Micro end mills

4472-2

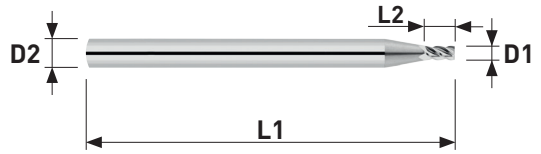

SWISS  MADE



Art. N°	D1 +0.005 -0.010	L2	D2 h4	L1	N	TiAlN	TiCN	ALFA- TOP
4472-2-0.30	0.30	0.60	3.00	39	■	■	■	■
4472-2-0.40	0.40	0.80	3.00	39	■	■	■	■
4472-2-0.50	0.50	1.00	3.00	39	■	■	■	■
4472-2-0.60	0.60	1.20	3.00	39	■	■	■	■
4472-2-0.70	0.70	1.40	3.00	39	■	■	■	■
4472-2-0.80	0.80	1.60	3.00	39	■	■	■	■
4472-2-0.90	0.90	1.80	3.00	39	■	■	■	■
4472-2-1.00	1.00	2.00	3.00	39	■	■	■	■
4472-2-1.10	1.10	2.20	3.00	39	■	■	■	■
4472-2-1.20	1.20	2.40	3.00	39	■	■	■	■
4472-2-1.30	1.30	2.60	3.00	39	■	■	■	■
4472-2-1.40	1.40	2.80	3.00	39	■	■	■	■
4472-2-1.50	1.50	3.00	3.00	39	■	■	■	■
4472-2-1.60	1.60	3.20	3.00	39	■	■	■	■
4472-2-1.70	1.70	3.40	3.00	39	■	■	■	■
4472-2-1.80	1.80	3.60	3.00	39	■	■	■	■
4472-2-1.90	1.90	3.80	3.00	39	■	■	■	■
4472-2-2.00	2.00	4.00	3.00	39	■	■	■	■
4472-2-2.10	2.10	4.20	3.00	39	■	■	■	■
4472-2-2.20	2.20	4.40	3.00	39	■	■	■	■
4472-2-2.30	2.30	4.60	3.00	39	■	■	■	■
4472-2-2.40	2.40	4.80	3.00	39	■	■	■	■
4472-2-2.50	2.50	5.00	3.00	39	■	■	■	■
4472-2-2.60	2.60	5.20	3.00	39	■	■	■	■
4472-2-2.70	2.70	5.40	3.00	39	■	■	■	■
4472-2-2.80	2.80	5.60	3.00	39	■	■	■	■
4472-2-2.90	2.90	5.80	3.00	39	■	■	■	■

Micro-fraises
Mikropräzisionsfräser
Micro end mills

4472-4

SWISS  MADE

MD VHM HM	λ 40°	Sharp Corner		4xD1	Z = 4	
-----------------	---------------	-----------------	---	------	-------	---

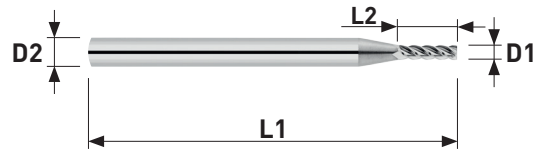

Art. N°	D1 +0.005 -0.010	L2	D2 h4	L1	N	TiAlN	TiCN	ALFA- TOP
4472-4-0.40	0.40	1.60	3.00	39	■	■	■	■
4472-4-0.50	0.50	2.00	3.00	39	■	■	■	■
4472-4-0.60	0.60	2.40	3.00	39	■	■	■	■
4472-4-0.70	0.70	2.80	3.00	39	■	■	■	■
4472-4-0.80	0.80	3.20	3.00	39	■	■	■	■
4472-4-0.90	0.90	3.60	3.00	39	■	■	■	■
4472-4-1.00	1.00	4.00	3.00	39	■	■	■	■
4472-4-1.10	1.10	4.40	3.00	39	■	■	■	■
4472-4-1.20	1.20	4.80	3.00	39	■	■	■	■
4472-4-1.30	1.30	5.20	3.00	39	■	■	■	■
4472-4-1.40	1.40	5.60	3.00	39	■	■	■	■
4472-4-1.50	1.50	6.00	3.00	39	■	■	■	■
4472-4-1.60	1.60	6.40	3.00	39	■	■	■	■
4472-4-1.70	1.70	6.80	3.00	39	■	■	■	■
4472-4-1.80	1.80	7.20	3.00	39	■	■	■	■
4472-4-1.90	1.90	7.60	3.00	39	■	■	■	■
4472-4-2.00	2.00	8.00	3.00	39	■	■	■	■
4472-4-2.10	2.10	8.40	3.00	39	■	■	■	■
4472-4-2.20	2.20	8.80	3.00	39	■	■	■	■
4472-4-2.30	2.30	9.20	3.00	39	■	■	■	■
4472-4-2.40	2.40	9.60	3.00	39	■	■	■	■
4472-4-2.50	2.50	10.00	3.00	39	■	■	■	■
4472-4-2.60	2.60	10.40	3.00	39	■	■	■	■
4472-4-2.70	2.70	10.80	3.00	39	■	■	■	■
4472-4-2.80	2.80	11.20	3.00	39	■	■	■	■
4472-4-2.90	2.90	11.60	3.00	39	■	■	■	■

Micro-fraises
Mikropräzisionsfräser
Micro end mills

DHP4470-3

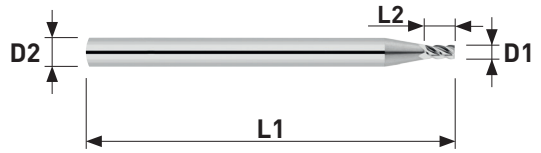

SWISS  MADE



Art. N°	D1 +0.005 -0.010	L2	D2 h ₄	L1	N	TiAlN	TiCN	ALFA- TOP
DHP4470-3-0.50	0.50	1.50	3.00	39	■			
DHP4470-3-0.60	0.60	1.80	3.00	39	■			
DHP4470-3-0.70	0.70	2.10	3.00	39	■	■	■	■
DHP4470-3-0.80	0.80	2.40	3.00	39	■	■	■	■
DHP4470-3-0.90	0.90	2.70	3.00	39	■	■	■	■
DHP4470-3-1.00	1.00	3.00	3.00	39	■	■	■	■
DHP4470-3-1.10	1.10	3.30	3.00	39	■	■	■	■
DHP4470-3-1.20	1.20	3.60	3.00	39	■	■	■	■
DHP4470-3-1.30	1.30	3.90	3.00	39	■	■	■	■
DHP4470-3-1.40	1.40	4.20	3.00	39	■	■	■	■
DHP4470-3-1.50	1.50	4.50	3.00	39	■	■	■	■
DHP4470-3-1.60	1.60	4.80	3.00	39	■	■	■	■
DHP4470-3-1.70	1.70	5.10	3.00	39	■	■	■	■
DHP4470-3-1.80	1.80	5.40	3.00	39	■	■	■	■
DHP4470-3-1.90	1.90	5.70	3.00	39	■	■	■	■
DHP4470-3-2.00	2.00	6.00	3.00	39	■	■	■	■
DHP4470-3-2.50	2.50	7.50	3.00	39	■	■	■	■

Micro-fraises
Mikropräzisionsfräser
Micro end mills

4278-0.75

SWISS  MADE



Art. N°	D1 <small>+0.005 -0.010</small>	R	L2	D2 <small>h4</small>	L1	N	TiAlN	TiCN	ALFA- TOP
4278-0.75-0.20	0.20	0.10	0.15	3.00	39	■			
4278-0.75-0.30	0.30	0.15	0.20	3.00	39	■	■	■	■
4278-0.75-0.40	0.40	0.20	0.30	3.00	39	■	■	■	■
4278-0.75-0.50	0.50	0.25	0.37	3.00	39	■	■	■	■
4278-0.75-0.60	0.60	0.30	0.45	3.00	39	■	■	■	■
4278-0.75-0.80	0.80	0.40	0.60	3.00	39	■	■	■	■
4278-0.75-1.00	1.00	0.50	0.75	3.00	39	■	■	■	■



Micro-fraises
Mikropräzisionsfräser
Micro end mills

4278-1.5

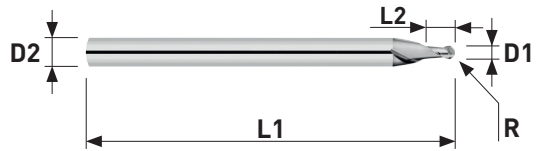

SWISS MADE



Art. N°	D1 +0.005 -0.010	R	L2	D2 h4	L1	N	TiAlN	TiCN	ALFA- TOP
4278-1.5-0.20	0.20	0.10	0.30	3.00	39	■			
4278-1.5-0.25	0.25	0.12	0.35	3.00	39	■			
4278-1.5-0.30	0.30	0.15	0.45	3.00	39	■	■	■	■
4278-1.5-0.40	0.40	0.20	0.60	3.00	39	■	■	■	■
4278-1.5-0.50	0.50	0.25	0.75	3.00	39	■	■	■	■
4278-1.5-0.60	0.60	0.30	0.90	3.00	39	■	■	■	■
4278-1.5-0.70	0.70	0.35	1.05	3.00	39	■	■	■	■
4278-1.5-0.80	0.80	0.40	1.20	3.00	39	■	■	■	■
4278-1.5-0.90	0.90	0.45	1.35	3.00	39	■	■	■	■
4278-1.5-1.00	1.00	0.50	1.50	3.00	39	■	■	■	■
4278-1.5-1.10	1.10	0.55	1.65	3.00	39	■	■	■	■
4278-1.5-1.20	1.20	0.60	1.80	3.00	39	■	■	■	■
4278-1.5-1.30	1.30	0.65	1.95	3.00	39	■	■	■	■
4278-1.5-1.40	1.40	0.70	2.10	3.00	39	■	■	■	■
4278-1.5-1.50	1.50	0.75	2.25	3.00	39	■	■	■	■
4278-1.5-1.60	1.60	0.80	2.40	3.00	39	■	■	■	■
4278-1.5-1.80	1.80	0.90	2.70	3.00	39	■	■	■	■
4278-1.5-2.00	2.00	1.00	3.00	3.00	39	■	■	■	■
4278-1.5-2.50	2.50	1.25	3.75	3.00	39	■	■	■	■

Micro-fraises
Mikropräzisionsfräser
Micro end mills

4278-3

SWISS  MADE

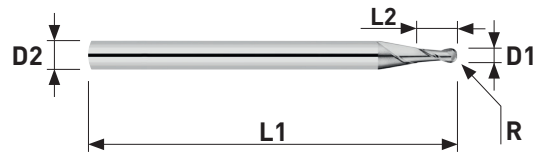

Art. N°	D1 +0.005 -0.010	R	L2	D2 h4	L1	N	TiAlN	TiCN	ALFA- TOP
4278-3-0.20	0.20	0.10	0.60	3.00	39	■			
4278-3-0.30	0.30	0.15	1.00	3.00	39	■	■	■	■
4278-3-0.40	0.40	0.20	1.00	3.00	39	■	■	■	■
4278-3-0.50	0.50	0.25	1.50	3.00	39	■	■	■	■
4278-3-0.60	0.60	0.30	1.50	3.00	39	■	■	■	■
4278-3-0.70	0.70	0.35	2.00	3.00	39	■	■	■	■
4278-3-0.80	0.80	0.40	2.00	3.00	39	■	■	■	■
4278-3-0.90	0.90	0.45	2.50	3.00	39	■	■	■	■
4278-3-1.00	1.00	0.50	3.00	3.00	39	■	■	■	■
4278-3-1.20	1.20	0.60	4.00	3.00	39	■	■	■	■
4278-3-1.40	1.40	0.70	4.00	3.00	39	■	■	■	■
4278-3-1.50	1.50	0.75	4.00	3.00	39	■	■	■	■
4278-3-1.60	1.60	0.80	4.00	3.00	39	■	■	■	■
4278-3-1.80	1.80	0.90	5.50	3.00	39	■	■	■	■
4278-3-2.00	2.00	1.00	6.00	3.00	39	■	■	■	■
4278-3-2.10	2.10	1.05	6.00	3.00	39	■	■	■	■
4278-3-2.20	2.20	1.10	6.00	3.00	39	■	■	■	■
4278-3-2.50	2.50	1.25	7.50	3.00	39	■	■	■	■
4278-3-2.80	2.80	1.40	8.40	3.00	39	■	■	■	■
4278-3-2.90	2.90	1.45	8.70	3.00	39	■	■	■	■

4000



Rubrique	Type	Dents	Corps	Angle d'hélice	Diamètre	Page	
Rubrik	Typ	Zähne	Schaft	Spiralwinkel	Durchmesser	Seite	
Section	Type	Teeth	Shank	Angle	Diameter	Page	
Paramètres							
Schnittwerte						4.02-4.03	
Data							
Fraises en bout Schafffräser End mills	 4230	Z2	Ø6	30°	Ø1.00 - 6.00	4.04	
	4231	Z2	D1 = D2	30°	Ø2.00 - 6.00	4.05	
	4330-S	Z3	Ø6	30°	Ø1.00 - 6.00	4.06	
	4330	Z3	D1 = D2	30°	Ø3.00 - 6.00	4.07	
	4331	Z3	D1 = D2	30°	Ø2.00 - 6.00	4.08	
	4336-HA	Z3	Ø6	30°	Ø1.50 - 6.00	4.09	
	MD 4337-HA	Z3	Ø6	30°	Ø1.50 - 6.00	4.10	
	VHM 4341	Z3	D1 = D2	45°	Ø2.00 - 6.00	4.11	
	HM 4361	Z3	D1 = D2	60°	Ø2.00 - 6.00	4.12	
	 DHP4336	Z3	Ø6	35°/38°	Ø1.00 - 6.00	4.13	
	 4430	Z4	D1 = D2	30°	Ø3.00 - 6.00	4.14	
	4431	Z4	D1 = D2	30°	Ø2.00 - 6.00	4.15	
	 4440-S	Z4	Ø6	45°	Ø1.00 - 6.00	4.16	
4441	Z4	D1 = D2	45°	Ø2.00 - 6.00	4.17		
 DHP4436	Z4	Ø6	35°/38°	Ø1.00 - 6.00	4.18		
Fraises en bout hémisphériques	MD	4238	Z2	D1 = D2	30°	Ø2.00 - 6.00	4.19
Schafffräser mit Radius	VHM						
End mills with radius	HM	4338	Z3	D1 = D2	30°	Ø2.00 - 6.00	4.20
Fraises à angler	MD	4911	Z3	Ø3h4	90°	Ø0.50 - 3.00	4.21
Kegelsenker	VHM						
Chamfering tools	HM	4901	Z4	D = D	90°	Ø3.00 - 8.00	4.22

Matière Werkstoff Material	Lubrifiant* Kühlung* Coolant*	Vc [m/min]	fz [mm] Ø 2 - 4	fz [mm] Ø 4 - 6
Acier inoxydable Rostfreier Stahl Stainless steel	O / E	40 - 80	0.010 - 0.030	0.015 - 0.040
Acier Stahl <700 N/mm ² Steel	O / E	60 - 100	0.010 - 0.030	0.015 - 0.040
Acier Stahl >700 N/mm ² Steel	O / E	40 - 70	0.008 - 0.020	0.010 - 0.030
Titane Titan Titanium	O / E	25 - 50	0.010 - 0.030	0.015 - 0.040
Aluminium	O / E	100 - 250	0.015 - 0.050	0.020 - 0.060
Cuivre Kupfer Copper	A / O / E	80 - 160	0.010 - 0.040	0.020 - 0.060
Laiton Messing Brass	A / O / E	100 - 200	0.015 - 0.040	0.030 - 0.070

Avec revêtement, augmenter les valeurs de 20 %
Mit Beschichtung, Daten um 20 % erhöhen
With coating, increase data by 20 %

*O = huile de coupe / Schneidöl / cutting oil
*E = emulsion
*A = sec (air comprimé) / trocken (Druckluft) / dry (air)

Matière Werkstoff Material	Lubrifiant* Kühlung* Coolant*	Vc [m/min]	Non revêtu Unbeschichtet Uncoated	Revêtu Beschichtet Coated
Acier inoxydable Rostfreier Stahl Stainless steel	O / E	40 - 90	+	++
Acier Stahl <700 N/mm ² Steel	O / E	60 - 120	+	++
Acier Stahl >700 N/mm ² Steel	O / E	50 - 80	-	++
Titane Titan Titanium	O / E	30 - 80	++	+
Aluminium	O / E	100 - 300	++	-
Cuivre Kupfer Copper	A / O / E	80 - 200	-	++
Laiton Messing Brass	A / O / E	100 - 250	++	-

Avec revêtement, augmenter les valeurs de 20 %
Mit Beschichtung, Daten um 20 % erhöhen
With coating, increase data by 20 %

*O = huile de coupe / Schneidöl / cutting oil
*E = emulsion
*A = sec (air comprimé) / trocken (Druckluft) / dry (air)

Fraises en bout
Schafffräser
End mills

4230

SWISS  MADE

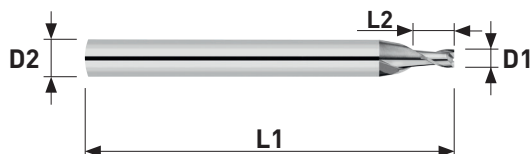

Art. N°	D1 h10	L2	D2 h6	L1	N	TiAlN
4230-1.00	1.00	1.00	6.00	50	■	■
4230-1.50	1.50	1.50	6.00	50	■	■
4230-2.00	2.00	2.00	6.00	50	■	■
4230-2.50	2.50	2.50	6.00	50	■	■
4230-3.00	3.00	3.00	6.00	50	■	■
4230-4.00	4.00	4.00	6.00	50	■	■
4230-5.00	5.00	5.00	6.00	50	■	■
4230-6.00	6.00	6.00	6.00	50	■	■



Fraises en bout
Schafffräser
End mills

4231

SWISS  MADE

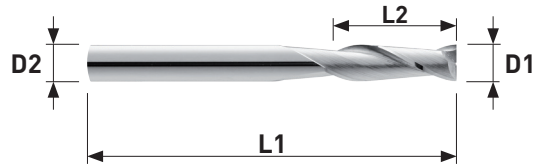

Art. N°	D1 e9	L2	D2 h6	L1	N	TiAlN 
4231-2.0	2.00	8.00	2.00	32	■	■
4231-2.5	2.50	8.00	2.50	32	■	■
4231-3.0	3.00	12.00	3.00	32	■	■
4231-3.5	3.50	12.00	3.50	32	■	■
4231-4.0	4.00	12.00	4.00	40	■	■
4231-4.5	4.50	14.00	4.50	50	■	■
4231-5.0	5.00	14.00	5.00	50	■	■
4231-6.0	6.00	16.00	6.00	50	■	■



Fraises en bout
Schafffräser
End mills

4330-S

SWISS  MADE

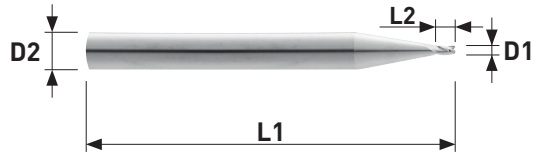

Art. N°	D1 h10	L2	D2 h6	L1	N	TiAlN 
4330-1.0-S	1.00	3.00	6.00	40	■	■
4330-1.5-S	1.50	3.00	6.00	40	■	■
4330-2.0-S	2.00	3.00	6.00	40	■	■
4330-2.5-S	2.50	3.00	6.00	40	■	■
4330-3.0-S	3.00	4.00	6.00	40	■	■
4330-3.5-S	3.50	4.00	6.00	40	■	■
4330-4.0-S	4.00	5.00	6.00	40	■	■
4330-4.5-S	4.50	5.00	6.00	40	■	■
4330-5.0-S	5.00	6.00	6.00	40	■	■
4330-6.0-S	6.00	7.00	6.00	40	■	■



Fraises en bout
Schafffräser
End mills

4330

SWISS  MADE

MD
VHM
HM

λ 30°

Sharp
Corner



Z = 3

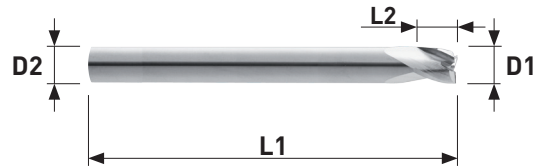

Art. N°	D1 e9	L2	D2 h6	L1	N	TiAlN 
4330-3.0	3.00	3.00	3.00	39	■	■
4330-4.0	4.00	4.00	4.00	50	■	■
4330-5.0	5.00	5.00	5.00	50	■	■
4330-6.0	6.00	6.00	6.00	50	■	■



Fraises en bout
Schafffräser
End mills

4331

SWISS  MADE

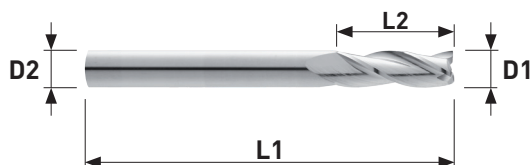

Art. N°	D1 e9	L2	D2 h6	L1	N	TiAlN 
4331-2.0	2.00	8.00	2.00	32	■	■
4331-2.5	2.50	8.00	2.50	32	■	■
4331-3.0	3.00	12.00	3.00	32	■	■
4331-3.5	3.50	12.00	3.50	32	■	■
4331-4.0	4.00	12.00	4.00	40	■	■
4331-4.5	4.50	14.00	4.50	50	■	■
4331-5.0	5.00	14.00	5.00	50	■	■
4331-6.0	6.00	16.00	6.00	50	■	■



Fraises en bout
Schafffräser
End mills

4336-HA

SWISS  MADE

MD
VHM
HM

λ 30°

Sharp
Corner



Z = 3

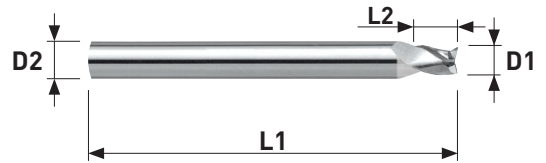

Art. N°	D1 h10	L2	D2 h6	L1	N	TiAlN 
4336-HA-1.5	1.50	3.00	6.00	50	■	■
4336-HA-1.8	1.80	3.00	6.00	50	■	■
4336-HA-2.0	2.00	3.00	6.00	50	■	■
4336-HA-2.5	2.50	3.00	6.00	50	■	■
4336-HA-2.8	2.80	4.00	6.00	50	■	■
4336-HA-3.0	3.00	4.00	6.00	50	■	■
4336-HA-3.5	3.50	4.00	6.00	50	■	■
4336-HA-3.8	3.80	5.00	6.00	54	■	■
4336-HA-4.0	4.00	5.00	6.00	54	■	■
4336-HA-4.5	4.50	5.00	6.00	54	■	■
4336-HA-4.8	4.80	6.00	6.00	54	■	■
4336-HA-5.0	5.00	6.00	6.00	54	■	■
4336-HA-5.5	5.50	7.00	6.00	54	■	■
4336-HA-5.8	5.80	7.00	6.00	54	■	■
4336-HA-6.0	6.00	7.00	6.00	54	■	■



Fraises en bout
Schafffräser
End mills

4337-HA

SWISS  MADE

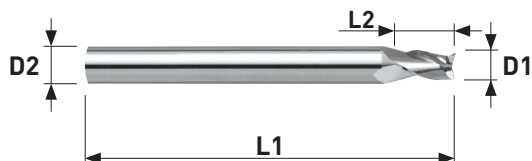

Art. N°	D1 h10	L2	D2 h6	L1	N	TiAlN 
4337-HA-1.5	1.50	6.00	6.00	57	■	■
4337-HA-1.8	1.80	6.00	6.00	57	■	■
4337-HA-2.0	2.00	6.00	6.00	57	■	■
4337-HA-2.5	2.50	6.00	6.00	57	■	■
4337-HA-2.8	2.80	7.00	6.00	57	■	■
4337-HA-3.0	3.00	7.00	6.00	57	■	■
4337-HA-3.5	3.50	7.00	6.00	57	■	■
4337-HA-3.8	3.80	8.00	6.00	57	■	■
4337-HA-4.0	4.00	8.00	6.00	57	■	■
4337-HA-4.5	4.50	8.00	6.00	57	■	■
4337-HA-4.8	4.80	10.00	6.00	57	■	■
4337-HA-5.0	5.00	10.00	6.00	57	■	■
4337-HA-5.5	5.50	10.00	6.00	57	■	■
4337-HA-5.8	5.80	10.00	6.00	57	■	■
4337-HA-6.0	6.00	10.00	6.00	57	■	■

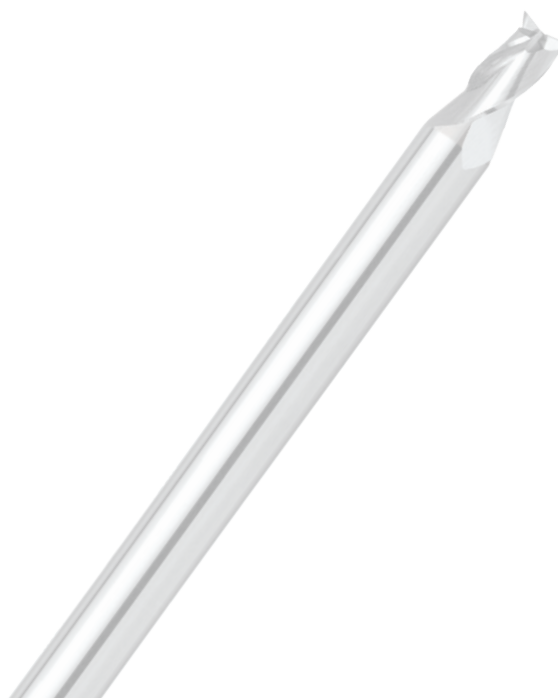

Fraises en bout
Schafffräser
End mills

4341

SWISS  MADE

MD
VHM
HM

λ 45°

Sharp
Corner



Z = 3

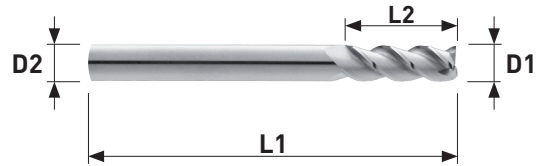

Art. N°	D1 e9	L2	D2 h6	L1	N	TiAlN 
4341-2.0	2.00	8.00	2.00	32	■	■
4341-2.5	2.50	8.00	2.50	32	■	■
4341-3.0	3.00	12.00	3.00	32	■	■
4341-3.5	3.50	12.00	3.50	32	■	■
4341-4.0	4.00	12.00	4.00	40	■	■
4341-4.5	4.50	14.00	4.50	50	■	■
4341-5.0	5.00	14.00	5.00	50	■	■
4341-6.0	6.00	16.00	6.00	50	■	■



Fraises en bout
Schafffräser
End mills

4361

SWISS  MADE

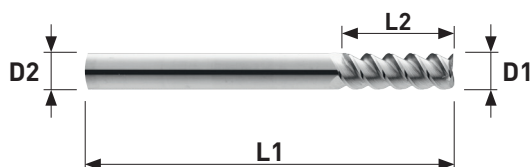

Art. N°	D1 e9	L2	D2 h6	L1	N	TiAlN 
4361-2.0	2.00	8.00	2.00	32	■	■
4361-2.5	2.50	8.00	2.50	32	■	■
4361-3.0	3.00	12.00	3.00	32	■	■
4361-3.5	3.50	12.00	3.50	32	■	■
4361-4.0	4.00	12.00	4.00	40	■	■
4361-4.5	4.50	14.00	4.50	50	■	■
4361-5.0	5.00	14.00	5.00	50	■	■
4361-6.0	6.00	16.00	6.00	50	■	■



Fraises en bout
Schafffräser
End mills

DHP4336

SWISS  MADE

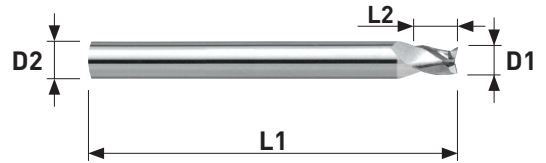

Art. N°	D1 h10	L2	D2 h6	L1	N	TiAlN
DHP4336-1.00	1.00	4.00	6.00	40	■	■
DHP4336-1.50	1.50	4.00	6.00	40	■	■
DHP4336-2.00	2.00	4.00	6.00	40	■	■
DHP4336-2.50	2.50	4.00	6.00	40	■	■
DHP4336-3.00	3.00	5.00	6.00	40	■	■
DHP4336-3.50	3.50	5.00	6.00	40	■	■
DHP4336-4.00	4.00	6.00	6.00	40	■	■
DHP4336-5.00	5.00	7.00	6.00	40	■	■
DHP4336-6.00	6.00	8.00	6.00	40	■	■



Fraises en bout
Schafffräser
End mills

4430

SWISS  MADE

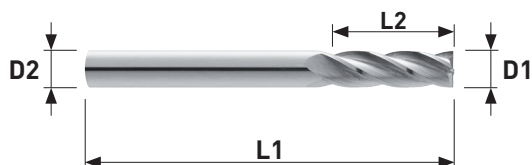

Art. N°	D1 e9	L2	D2 h6	L1	N	TiAlN
4430-3.00	3.00	3.00	3.00	39	■	■
4430-4.00	4.00	4.00	4.00	50	■	■
4430-5.00	5.00	5.00	5.00	50	■	■
4430-6.00	6.00	6.00	6.00	50	■	■



Fraises en bout
Schafffräser
End mills

4431

SWISS  MADE

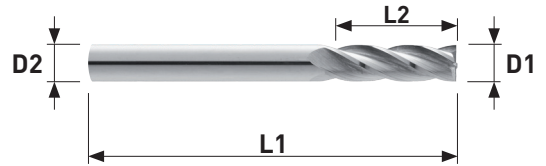

Art. N°	D1 e9	L2	D2 h6	L1	N	TiAlN 
4431-2.0	2.00	8.00	2.00	32	■	■
4431-2.5	2.50	8.00	2.50	32	■	■
4431-3.0	3.00	12.00	3.00	32	■	■
4431-3.5	3.50	12.00	3.50	32	■	■
4431-4.0	4.00	12.00	4.00	40	■	■
4431-4.5	4.50	14.00	4.50	50	■	■
4431-5.0	5.00	14.00	5.00	50	■	■
4431-6.0	6.00	16.00	6.00	50	■	■



Fraises en bout
Schafffräser
End mills

4440-S

SWISS  MADE

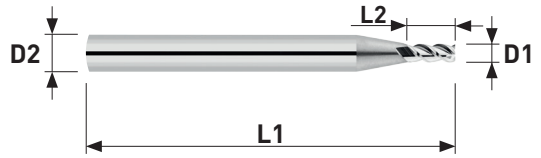

Art. N°	D1 h10	L2	D2 h6	L1	N	TiAlN
4440-1.0-S	1.00	2.00	6.00	40	■	■
4440-1.5-S	1.50	3.00	6.00	40	■	■
4440-2.0-S	2.00	4.00	6.00	40	■	■
4440-2.5-S	2.50	5.00	6.00	40	■	■
4440-3.0-S	3.00	6.00	6.00	40	■	■
4440-3.5-S	3.50	7.00	6.00	40	■	■
4440-4.0-S	4.00	8.00	6.00	40	■	■
4440-4.5-S	4.50	9.00	6.00	40	■	■
4440-5.0-S	5.00	10.00	6.00	40	■	■
4440-5.5-S	5.50	11.00	6.00	40	■	■
4440-6.0-S	6.00	12.00	6.00	40	■	■



Fraises en bout
Schafffräser
End mills

4441

SWISS  MADE

MD
VHM
HM

λ 45°

Sharp
Corner



Z = 4

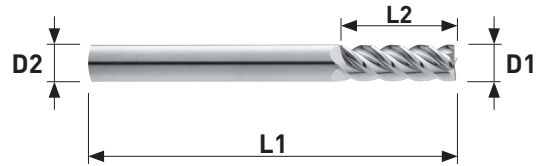

Art. N°	D1 e9	L2	D2 h6	L1	N	TiAlN 
4441-2.0	2.00	8.00	2.00	32	■	■
4441-2.5	2.50	8.00	2.50	32	■	■
4441-3.0	3.00	12.00	3.00	32	■	■
4441-3.5	3.50	12.00	3.50	32	■	■
4441-4.0	4.00	12.00	4.00	40	■	■
4441-4.5	4.50	14.00	4.50	50	■	■
4441-5.0	5.00	14.00	5.00	50	■	■
4441-6.0	6.00	16.00	6.00	50	■	■



Fraises en bout
Schafffräser
End mills

DHP4436

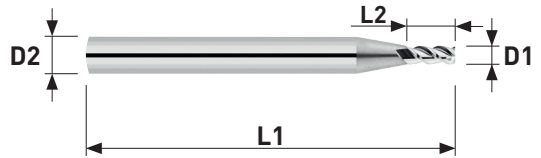

SWISS  MADE



Art. N°	D1 h10	L2	D2 h6	L1	N	TiAlN
DHP4436-1.00	1.00	4.00	6.00	40	■	■
DHP4436-1.50	1.50	4.00	6.00	40	■	■
DHP4436-2.00	2.00	4.00	6.00	40	■	■
DHP4436-2.50	2.50	4.00	6.00	40	■	■
DHP4436-3.00	3.00	5.00	6.00	40	■	■
DHP4436-3.50	3.50	5.00	6.00	40	■	■
DHP4436-4.00	4.00	6.00	6.00	40	■	■
DHP4436-5.00	5.00	7.00	6.00	40	■	■
DHP4436-6.00	6.00	8.00	6.00	40	■	■



Fraises en bout
Schafffräser
End mills

4238

SWISS  MADE

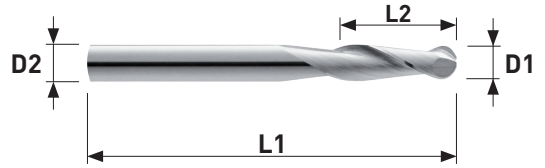

Art. N°	D1 e9	L2	D2 h6	L1	N	TiAlN 
4238-2.0	2.00	8.00	2.00	32	■	■
4238-2.5	2.50	8.00	2.50	32	■	■
4238-3.0	3.00	12.00	3.00	32	■	■
4238-3.5	3.50	12.00	3.50	32	■	■
4238-4.0	4.00	12.00	4.00	40	■	■
4238-4.5	4.50	14.00	4.50	50	■	■
4238-5.0	5.00	14.00	5.00	50	■	■
4238-6.0	6.00	16.00	6.00	50	■	■



Fraises en bout
Schafffräser
End mills

4338

SWISS  MADE

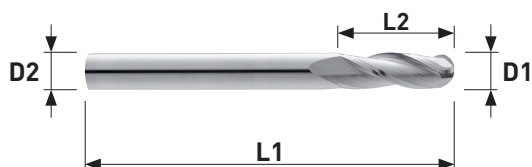

Art. N°	D1 e9	L2	D2 h6	L1	N	TiAlN 
4338-2.0	2.00	8.00	2.00	32	■	■
4338-2.5	2.50	8.00	2.50	32	■	■
4338-3.0	3.00	12.00	3.00	32	■	■
4338-3.5	3.50	12.00	3.50	32	■	■
4338-4.0	4.00	12.00	4.00	40	■	■
4338-4.5	4.50	14.00	4.50	50	■	■
4338-5.0	5.00	14.00	5.00	50	■	■
4338-6.0	6.00	16.00	6.00	50	■	■



Fraises à angler
Kegelsenker
Chamfering tools

4911

SWISS  MADE

MD
VHM
HM

λ 0°



Z = 3

90°

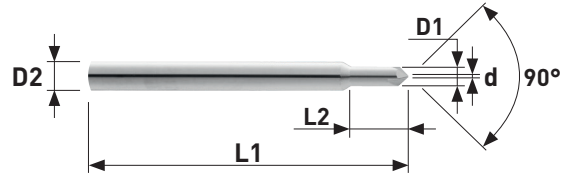

Art. N°	D1 +0.005 -0.010	L2	D2 h4	L1	d	N	TiAlN
4911-0.50	0.50	3.00	3.00	39	0.1	■	
4911-0.60	0.60	3.00	3.00	39	0.1	■	
4911-0.70	0.70	3.00	3.00	39	0.1	■	
4911-0.80	0.80	3.00	3.00	39	0.1	■	
4911-0.90	0.90	3.00	3.00	39	0.1	■	
4911-1.00	1.00	3.00	3.00	39	0.1	■	
4911-1.50	1.50	4.50	3.00	39	0.1	■	
4911-2.00	2.00	6.00	3.00	39	0.1	■	■
4911-2.50	2.50	7.50	3.00	39	0.1	■	■
4911-3.00	3.00	-	3.00	39	0.1	■	■

Fraises à angler
Kegelsenker
Chamfering tools

4901

SWISS  MADE

MD VHM HM	λ 0°		Z = 4	90°
-----------------	--------------	---	-------	-----

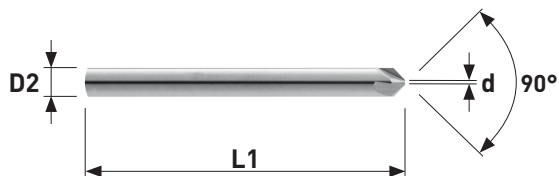

Art. N°	D h6	d	L1	N	TiAlN
4901-3.0	3.00	0.3	39	■	■
4901-6.0	6.00	0.7	50	■	■
4901-8.0	8.00	1.2	60	■	■



Outils spéciaux sur demande
Sonderwerkzeuge auf Anfrage
Special tools on request

En cas de besoin d'outils spéciaux, n'hésitez pas à nous faire parvenir votre demande.
 Une offre vous sera transmise dans les 24 heures.

Für Sonderanfertigungen können Sie uns gerne Ihre Anfrage mit Zeichnung zustellen.
 Unser Angebot erhalten Sie innerhalb von 24 Stunden.

For special tools, do not hesitate to contact us and provide your request.
 A quotation will be made within 24 hours.

Fraises à graver
Gravierfräser
Engraving mills

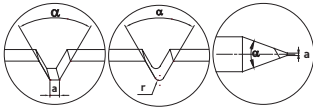

Forets
Bohrer
Drills

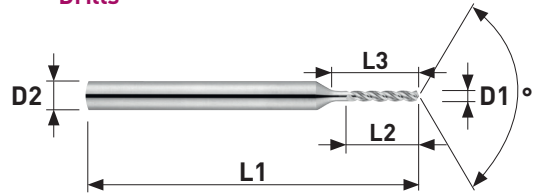
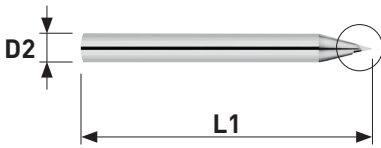

Micro-fraises / Fraises en bout
Mikropräzisionsfräser / Schaftfräser
Micro end mills / End mills

Fraises à angler
Kegelsenker
Chamfering tools

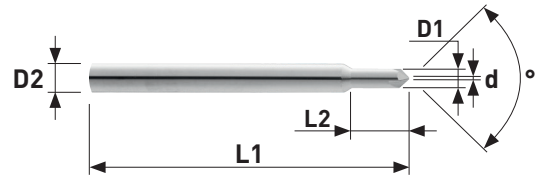
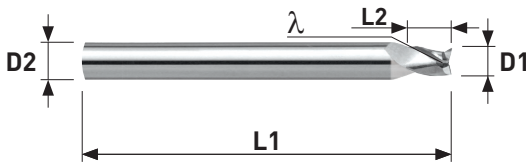

A remplir Auszufüllen To fill in	
D2	
D1	
d	
L1	
L2	
L3	
z	
α	
λ	
\circ	
a	
r	

5000

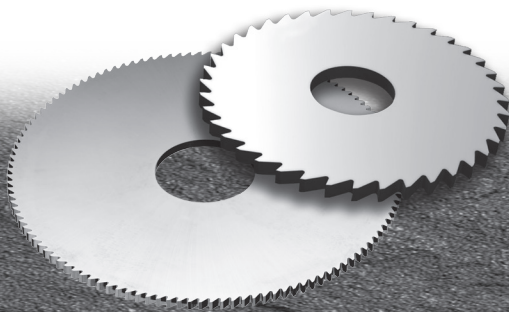

Rubrique Rubrik Section		Type Typ Type	Diamètre Durchmesser Diameter	Page Seite Page
Paramètres Schnittwerte Data				6.03
Fraises circulaires MD VHM-Kreissägeblätter Carbide slitting saws HM	Denture fine Feine Verzahnung Fine teeth	5101	Ø15 - 160	6.04
	Denture grossière Grosse Verzahnung Large teeth	5102	Ø15 - 160	6.05
	Denture extra-fine Extra feine Verzahnung Extra fine teeth	5103	Ø8 - 80	6.06-6.07
	 Denture et traitement pour INOX Verzahnung beschichtet für INOX Teeth coated for INOX	5104	Ø63 - 100	6.08
	Serrage avant R Spannung von vorne R With front clamping R	2810 2811	- -	6.09 6.09
	Petit Ø Kleiner Ø Small Ø	2815	-	6.09
Tasseaux Fräsdorne Milling arbors	Serrage arrière R Spannung von hinten R With rear clamping R	2820	-	6.10
	Serrage arrière L Spannung von hinten L With rear clamping L	1820	-	6.10
	Pièces de rechange Ersatzteile Spare parts			6.11

Définition du nombre de dents
Empfohlene Zähnezahl
Recommended number of teeth

Idéalement 2-3 dents en contact

Im Idealfall 2-3 Zähne im Einsatz

Ideally 2-3 teeth in contact

Trop de dents = avance trop faible par dent /
 pas assez de place pour le copeau

Trop peu de dents = risque de vibration /
 usure prématurée

Zu viele Zähne = zu geringer Vorschub pro Zahn /
 zu kleiner Spanraum

Zu wenig Zähne = Vibrationen / Verschleissrisiko

Too many teeth = feed too low per tooth /
 not enough place for the chips

Not enough teeth = vibration / risk of quick wearout

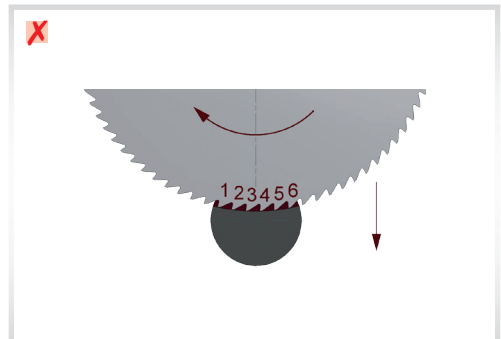
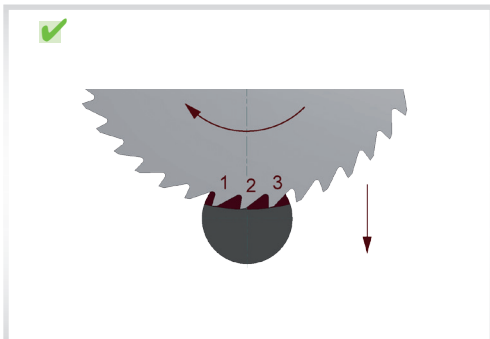
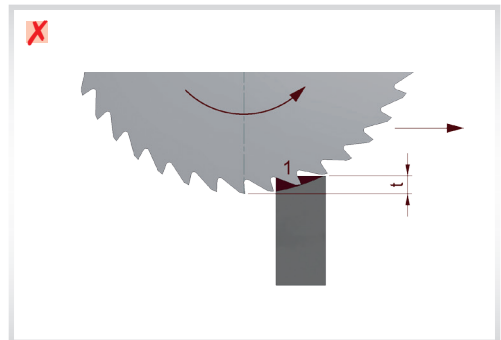
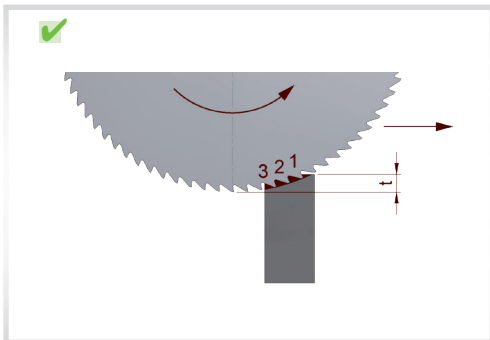
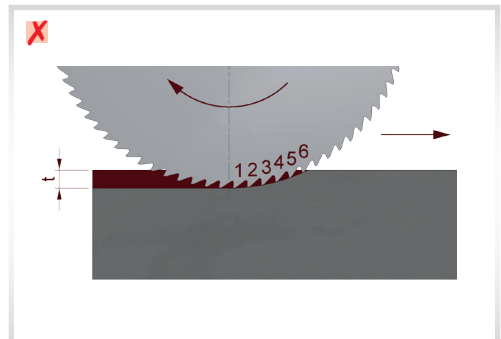
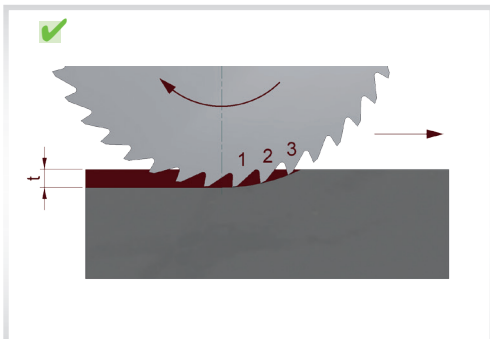

Matière Werkstoff Material	Lubrifiant* Kühlung* Coolant*	Vc [m/min]	Choix de la denture / avance Verzahnungswahl / Vorschub Teeth selection / cutting feed
Acier de décolletage Automatenstahl Free-cutting steel	O / E	120 - 240	<p>Type 5101</p> <ul style="list-style-type: none"> • Pour usinage peu profond ou longueur à fendre faible. Avance par dent : 0.005 - 0.05** • Für kleine Bearbeitungstiefen oder kurze Schlitzlängen. Vorschub pro Zahn : 0.005 - 0.05** • For low machining depth or short slots. Feed per tooth : 0.005 - 0.05** <p>Type 5102</p> <ul style="list-style-type: none"> • Pour usinage profond ou grande longueur à fendre. Avance par dent : 0.01 - 0.1** • Für grosse Bearbeitungstiefen oder grosse Schlitzlängen. Vorschub pro Zahn : 0.01 - 0.1** • For deep machining or long slots. Feed per tooth : 0.01 - 0.1** <p>Type 5103</p> <ul style="list-style-type: none"> • Pour usinage de pièces fragiles ou fines. Avance par dent : 0.002 - 0.02** • Für die Bearbeitung von empfindlichen oder dünnwandigen Werkstücken. Vorschub pro Zahn : 0.002 - 0.02** • For machining of fragile or thin workpieces. Feed per tooth : 0.002 - 0.02** <p>Type 5104</p> <ul style="list-style-type: none"> • Pour usinage profond ou grande longueur à fendre. Avance par dent : 0.015 - 0.15** • Für grosse Bearbeitungstiefen oder grosse Schlitzlängen. Vorschub pro Zahn : 0.015 - 0.15** • For deep machining or long slots. Feed per tooth : 0.015 - 0.15** <p>**selon la matière, l'épaisseur ainsi que la rigidité globale **je nach Werkstoff, Dicke und Gesamtstarrheit **according to material, thickness and global rigidity</p>
Acier Stahl <600 N/mm ² Steel	O / E	100 - 200	
Acier Stahl <800 N/mm ² Steel	O / E	80 - 160	
Acier Stahl <1000 N/mm ² Steel	O / E	60 - 120	
Acier Stahl >1000 N/mm ² Steel	O / E	40 - 80	
Acier inoxydable Rostfreistahl Stainless steel	O / E	50 - 100	
Acier réfractaire Warmfester Stahl Heat resistant steel	O / E	25 - 60	
Fonte Gusseisen Cast iron	A / E	60 - 120	
Aluminium Si <12%	O / E	150 - 600	
Aluminium Si >12%	O / E	80 - 300	
Titane Titan Titanium	O / E	30 - 60	
Cuivre, laiton, bronze Kupfer, Messing, Bronze Copper, brass, bronze	A / O / E	80 - 300	
Thermoplastique Thermoplaste Thermoplastics	A	200 - 700	
Duroplastique Duroplaste Duroplastics	A	150 - 600	

*O = huile de coupe / Schneidöl / cutting oil

*E = Emulsion

*A = sec (air comprimé) / trocken (Presluft) / dry (air)

Avec revêtement TiN/TiCN/TiAlN, augmenter les valeurs de 20 %
Mit TiN/TiCN/TiAlN Beschichtung, Daten um 20 % erhöhen
With TiN/TiCN/TiAlN coating, increase data by 20 %

Fraises circulaires
Kreissägeblätter
Slitting saws

5101

SWISS  MADE

MD
 VHM
 HM

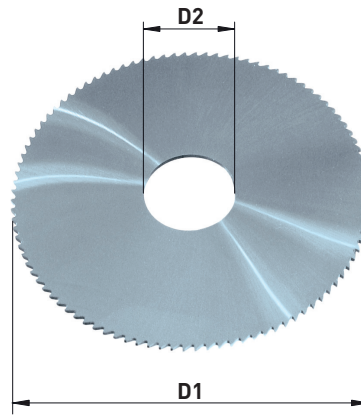

Denture fine Feine Verzahnung Fine teeth											DIN 1837	
D1 js 12 D2 H7	15	20	25	30	40	50	63	80	100	125	160	
Epaisseur Dicke Thickness	Nombre de dents Zähnezahl Number of teeth											
+/- 0.01	5	5	8	8	10	13	16	22	22	22	32	
0.10	64	80	80	100	128	-	-	-	-	-	-	
0.15	64	80	80	100	128	-	-	-	-	-	-	
0.20	64	80	80	100	128	128	160	-	-	-	-	
0.25	64	64	80	100	100	128	128	-	-	-	-	
0.30	64	64	80	80	100	128	128	160	-	-	-	
0.35	64	64	64	80	100	100	128	160	-	-	-	
0.40	64	64	64	80	100	100	128	160	-	-	-	
0.45	48	48	64	80	80	100	128	128	-	-	-	
0.50	48	48	64	80	80	100	128	128	160	-	-	
0.60	48	48	64	64	80	100	100	128	160	160	-	
0.70	48	48	48	64	80	80	100	128	128	160	-	
0.80	40	40	48	64	80	80	100	128	128	160	-	
0.90	40	40	48	64	64	80	100	100	128	160	-	
1.00	40	40	48	64	64	80	100	100	128	160	160	
1.10	40	40	48	48	64	80	80	100	128	128	-	
1.20	40	40	48	48	64	80	80	100	128	128	160	
1.30	40	40	40	48	64	64	80	100	100	-	-	
1.40	40	40	40	48	64	64	80	100	100	128	-	
1.50	40	40	40	48	64	64	80	100	100	128	160	
1.60	40	40	40	48	64	64	80	100	100	128	160	
1.70	40	32	40	48	48	64	80	80	100	-	-	
1.80	40	32	40	48	48	64	80	80	100	128	128	
1.90	40	32	40	48	48	64	80	80	100	-	-	
2.00	40	32	40	48	48	64	80	80	100	128	128	
2.50	40	32	40	40	48	64	64	80	100	100	128	
3.00	40	32	32	40	48	48	64	80	80	100	128	
3.50	24	24	32	40	40	48	64	64	80	100	-	
4.00	24	24	32	40	40	48	64	64	80	100	-	
5.00	24	24	32	32	40	48	48	64	80	100	-	
6.00	24	24	24	32	40	40	48	64	64	100	-	

Fraises circulaires
Kreissägeblätter
Slitting saws

5102

SWISS  MADE

MD
 VHM
 HM

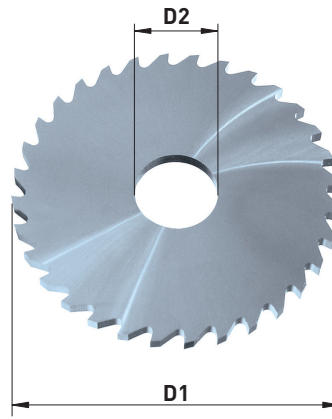

Denture grossière Grobe Verzahnung Large teeth												DIN 1838	
D1 js 12 D2 H7	15	20	25	30	40	50	63	80	100	125	160		
Epaisseur Dicke Thickness	Nombre de dents Zähnezahl Number of teeth												
+/- 0.01													
0.20	20	20	20	30	40	-	-	-	-	-	-		
0.25	20	20	20	30	40	-	-	-	-	-	-		
0.30	20	20	20	30	40	-	-	-	-	-	-		
0.40	20	20	20	30	40	48	64	-	-	-	-		
0.50	20	20	20	30	40	48	64	-	-	-	-		
0.60	20	20	20	30	40	48	48	64	80	-	-		
0.70	20	20	20	30	40	40	48	64	64	-	-		
0.80	20	20	20	24	32	40	48	64	64	80	-		
0.90	20	20	20	24	32	40	48	48	64	80	-		
1.00	20	20	20	24	32	40	48	48	64	80	80		
1.20	20	20	20	24	32	40	40	48	64	64	80		
1.50	20	20	20	24	32	32	40	48	48	64	80		
1.60	20	20	20	24	32	32	40	48	48	64	-		
1.80	20	20	20	24	24	32	40	40	48	64	-		
2.00	20	20	20	24	24	32	40	40	48	64	80		
2.50	20	20	20	24	24	32	32	40	48	48	80		
3.00	20	20	20	24	24	24	32	40	40	48	64		
4.00	20	20	20	24	20	24	32	32	40	48	-		
5.00	20	20	20	24	20	24	24	32	40	40	-		
6.00	20	20	20	24	20	20	24	32	32	40	-		

Fraises circulaires
Kreissägeblätter
Slitting saws

5103

SWISS  MADE

MD
VHM
HM

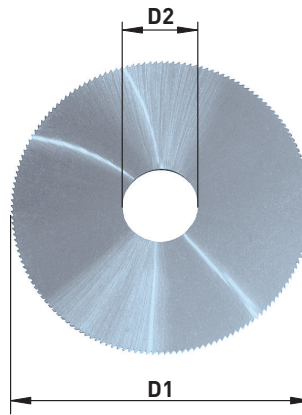

Denture extra-fine Extra feine Verzahnung Extra fine teeth												
D1 js 12 D2 H7	8	10	12	15	20	20	20	25	25	25	30	32
	3	3	5	5	5	5	6	5	6	8	8	8
Epaisseur Dicke Thickness	Nombre de dents Zähnezahl Number of teeth											
+/- 0.01												
0.10	48	64	64	80	*	100	80	80	-	-	-	-
0.15	48	64	64	80	*	100	80	80	100	100	*	80
0.20	48	64	64	80	*	100	80	80	100	100	*	80
0.25	48	64	64	80	80	100	80	80	100	100	*	80
0.30	48	64	64	80	80	100	80	80	100	100	100	80
0.35	48	64	64	80	80	-	80	80	100	100	100	80
0.40	48	64	64	80	80	100	80	80	100	100	100	80
0.50	48	64	64	80	80	100	80	80	100	100	100	80
0.60	48	64	64	80	80	-	80	80	100	100	100	80
0.70	48	64	64	80	80	-	80	80	100	100	100	80
0.80	48	64	64	80	80	-	80	80	100	100	100	80
0.90	48	64	64	80	80	-	80	80	100	100	100	80
1.00	48	64	64	80	80	-	80	80	100	100	100	80
1.20	-	-	-	80	80	-	80	80	100	100	100	80
1.50	-	-	-	80	80	-	80	80	100	100	100	80
2.00	-	-	-	80	80	-	80	80	100	100	100	80
2.50	-	-	-	80	80	-	80	80	100	100	100	80
3.00	-	-	-	80	80	-	80	80	100	100	100	80

Dimensions \emptyset 35 - \emptyset 80, voir p. 6.07
Abmessungen \emptyset 35 - \emptyset 80, siehe S. 6.07
Dimensions \emptyset 35 - \emptyset 80, see p. 6.07

* = voir type 5101
* = siehe Typ 5101
* = see type 5101

Fraises circulaires
Kreissägeblätter
Slitting saws

5103

SWISS  MADE

MD
VHM
HM

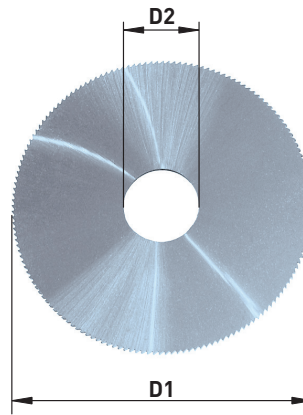

Denture extra-fine Extra feine Verzahnung Extra fine teeth												
D1 js 12 D2 H7	35	40	40	40	40	45	45	50	50	63	80	
	8	8	8	10	10	8	8	10	13	16	16	
Epaisseur Dicke Thickness	Nombre de dents Zähnezahl Number of teeth											
+/- 0.01												
0.10	-	-	-	-	-	-	-	-	-	-	-	-
0.15	96	100	160	100	160	100	160	-	-	-	-	
0.20	96	100	160	100	160	100	160	100	-	-	-	
0.25	96	100	160	*	160	100	160	100	120	120	-	
0.30	96	100	160	*	160	100	160	100	120	120	-	
0.35	96	100	160	*	160	100	160	100	120	120	-	
0.40	96	100	160	*	160	100	160	100	120	120	-	
0.50	96	100	160	100	160	100	160	100	120	120	128	
0.60	96	100	160	100	160	100	160	100	120	120	128	
0.70	96	100	160	100	160	100	160	100	120	120	128	
0.80	96	100	160	100	160	100	160	100	120	120	128	
0.90	96	100	160	100	160	100	160	100	120	120	128	
1.00	96	100	160	100	160	100	160	100	120	120	128	
1.20	96	100	160	100	160	100	160	100	120	120	128	
1.50	96	100	160	100	160	100	160	100	120	120	128	
2.00	96	100	160	100	160	100	160	100	120	120	128	
2.50	96	100	160	100	160	100	160	100	120	120	128	
3.00	96	100	160	100	160	100	160	100	120	120	128	

Dimensions Ø 8 - Ø 32, voir p. 6.06
Abmessungen Ø 8 - Ø 32, siehe S. 6.06
Dimensions Ø 8 - Ø 32, see p. 6.06

* = voir type 5101
* = siehe Typ 5101
* = see type 5101

Fraises circulaires Maxinox
Maxinox Kreissägeblätter
Maxinox slitting saws

5104

SWISS  MADE

MD
 VHM
 HM

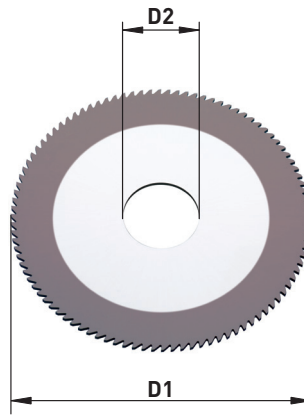

Denture et traitement pour INOX Verzahnung beschichtet für INOX Teeth coated for INOX				
D1 js 12 D2 H7	63 16	80 22	100 22	Maxinox
Epaisseur Dicke Thickness	Nombre de dents Zähnezahl Number of teeth			
+/- 0.01				
0.80	80	100	120	■
1.00	80	100	120	■



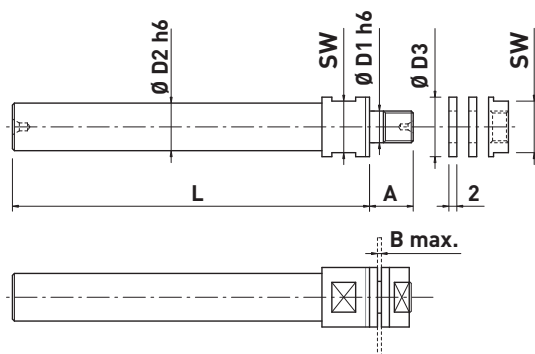

**Tasseaux
Fräsdorne
Milling arbors**

**2810 R
2811 R**

SWISS  MADE

Tasseaux pour rotation à droite (serrage avant avec filet à droite)
Fräsdorne für Drehrichtung rechts (Spannung von vorne mit Rechtsgewinde)
Arbors for right hand rotation (front clamping with right hand thread)

Art. N°	D1 h ₆	D2 h ₆	D3	L	A	SW	B
2810-5-6	5.00	6	10	70	9	8	6
2810-5-10	5.00	10	10	80	9	8	6
2810-6-10	6.00	10	12	80	9.5	10	6
2810-8-10	8.00	10	15	80	10	13	6
2810-8-12	8.00	12	15	90	10	13	6
2810-10-6	10.00	6	18	80	10.5	15	6
2810-10-10	10.00	10	18	80	10.5	15	6
2810-10-16	10.00	16	18	100	10.5	15	6
2810-13-16	13.00	16	22	110	11	19	6
2810-16-20	16.00	20	26	120	12	22	6
2810-22-16	22.00	16	32	120	13	27	6

Art. N°	D1 h ₆	D2 h ₆	D3	L	A	SW	B
2811-16-10	16.00	10	22	80	8	19	3

**Tasseaux
Fräsdorne
Milling arbors**

2815 R

SWISS  MADE

Tasseaux pour très petites fraises circulaires
Fräsdorne für sehr kleine Kreissägeblätter
Arbors for very small slitting saws

Art. N°	D1 h ₆	D2 h ₆	D3	L	A	SW	B
2815-3-5	3.00	5	5	60	7	4	3
2815-5-6	5.00	6	7.5	70	7	6	3

Chaque tasseau est livré avec 2 entretoises et 1 écrou
Jeder Fräsdorn wird mit 2 Abstandsrings und 1 Mutter geliefert
2 distance rings and 1 nut are included with each arbor

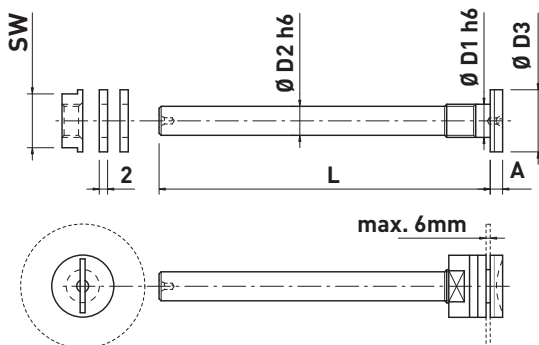

**Tasseaux
Fräsdorne
Milling arbors**

2820 R

SWISS  MADE

Tasseaux pour rotation à droite (serrage arrière avec filet à gauche) Fräsdorne für Drehrichtung rechts (Spannung von hinten mit Linksgewinde) Arbors for right hand rotation (rear clamping with left hand thread)						
Art. N°	D1 h ₆	D2 h ₆	D3	L	A	SW
2820-5-4	5.00	4	10	50	3	8
2820-6-5	6.00	5	12	60	3	10
2820-8-6	8.00	6	15	70	3	13
2820-8-7	8.00	7	15	80	3	13
2820-10-6	10.00	6	18	70	3.5	15
2820-10-8	10.00	8	18	90	3.5	15
2820-13-10	13.00	10	22	110	3.5	19
2820-16-12	16.00	12	26	120	3.5	22

**Tasseaux
Fräsdorne
Milling arbors**

1820 L

SWISS  MADE

Tasseaux pour rotation à gauche (serrage arrière avec filet à droite) Fräsdorne für Drehrichtung links (Spannung von hinten mit Rechtsgewinde) Arbors for right hand rotation (rear clamping with right hand thread)						
Art. N°	D1 h ₆	D2 h ₆	D3	L	A	SW
1820-5-4	5.00	4	10	50	3	8
1820-6-5	6.00	5	12	60	3	10
1820-8-6	8.00	6	15	70	3	13
1820-10-6	10.00	6	18	70	3.5	15

Chaque tasseau est livré avec 2 entretoises et 1 écrou
Jeder Fräsdorn wird mit 2 Abstandsrings und 1 Mutter geliefert
2 distance rings and 1 nut are included with each arbor

Pièces de rechange
Ersatzteile
Spare parts

SWISS  MADE

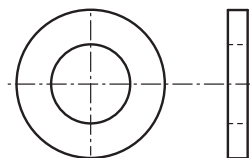

* Diamètre D1 à spécifier
* Durchmesser D1 angeben
* Diameter D1 to be specified

Art. N°

1820-D1*-a

2810-D1*-a

2811-D1*-a

2815-D1*-a

2820-D1*-a

Pièces de rechange
Ersatzteile
Spare parts

SWISS  MADE

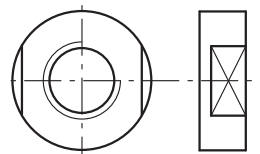

* Diamètre D1 à spécifier
* Durchmesser D1 angeben
* Diameter D1 to be specified

Art. N°

1820-D1*-b











2810-D1*-b

2811-D1*-b

2815-D1*-b

2820-D1*-b

Informations techniques et symboles Technische Informationen und Symbole Technical information and symbols

MD VHM HM	Métal dur Hartmetall Hard metal		2 dents avec coupe centrale 2 Zähne Zentrumschnitt 2 teeth center cutting
60°	Angle Winkel Angle		3 dents avec coupe centrale 3 Zähne Zentrumschnitt 3 teeth center cutting
λ 30°	Angle d'hélice Spiralwinkel Helix angle		4 dents avec coupe centrale 4 Zähne Zentrumschnitt 4 teeth center cutting
	2 lèvres, affûtage à facettes 2 Schneiden, Facettenschärfen 2 flutes, sharpening with facets		Denture décalée Verzahnung versetzt Teeth alterned
Z = 2	Nombre de dents Anzahl der Zähne Number of teeth	DHD	Denture décalée hélice différente Verzahnung versetzt unterschiedliche Spirale Teeth alterned helix different
2xD1	– 2xD1	DHP	Denture décalée hélice progressive Verzahnung versetzt progressive Spirale Teeth alterned helix progressive
	3 lèvres, affûtage à facettes 3 Schneiden, Facettenschärfen 3 flutes, sharpening with facets	λ 36° λ 38° λ 40°	Hélice différente Verschiedene Spirale Different propeller
	Taillage demi-lune Kanonenbohrer Spitze Gundrills tip	λ 35°/38°	Hélice progressive Progressive Spirale Progressiv propeller
	Taillage renforcé 3/4 3/4 Genuteter Fräser 3/4 straight fluted		Fraises hémisphériques Radiusfräser End mills with ball end
	Usinage radial, diagonal et axial Radiale, diagonale und axiale Bearbeitung Radial, diagonal and axial machining		Usinage radial et axial Radiale und axiale Bearbeitung Radial and axial machining
Sharp Corner	Coins vifs Scharfkantige Ecken Sharp corners		

Informations techniques et symboles
Technische Informationen und Symbole
Technical information and symbols

Matière/Material	N° 1	N° 2
Inox/Stainless steel	TiAlN	TiCN
Acier/Steel <700	TiCN	TiAlN
Acier /Steel >700	TiAlN	TiCN
Titane/Titan	TiAlN	ALFA-TOP
Aluminium	ALFA-TOP	TiAlN
Cuivre/Copper	ALFA-TOP	TiAlN
Laiton/Brass	N	ALFA-TOP
Or/Gold & Argent/Silver	N	ALFA-TOP
Graphite	Diamant/Diamond	ALFA-TOP
Polymères/Polymers	N	ALFA-TOP

Diamètre outil Werkzeughdurchmesser Tool diameter	D (mm)		
Nombre de dents Zähnezahl Number of teeth	Z		
Profondeur de coupe Schnitttiefe Cutting depth	ap (mm)		
Largeur de coupe Schnittbreite Cutting width	ae (mm)		
Vitesse de coupe Schnittgeschwindigkeit Cutting speed	(m/min)	Vc =	$\frac{D \times \pi \times n}{1000}$
Nombre de tours Umdrehungen Rotations	(U/min)	n =	$\frac{Vc \times 1000}{\pi \times D}$
Avance par dent Vorschub pro Zahn Cutting feed	(mm)	fz =	$\frac{Vf}{n \times Z}$
Vitesse d'avance Vorschubgeschwindigkeit Cutting speed	(mm/min)	Vf =	fz x Z x n
Débit d'enlèvement de copeaux Spanvolumen Removal of cutting up shaving	(mm ³ /min)	Q =	ap x ae x Vf
Avance par tour Vorschub pro Umdrehung Cutting feed per rotation	(mm/U)	f =	$\frac{Vf}{n}$

Nos propositions techniques s'appliquent à la plupart des utilisations courantes.

N'hésitez pas à nous contacter pour des conseils plus précis.

Diese technische Empfehlungen gelten für die Mehrzahl der Standardanwendungen.

Unsere Techniker beraten Sie gerne für spezifische Anliegen.

These technical propositions apply to the majority of standard usages.

Do not hesitate to contact us for more specific advices.

Conditions générales de vente et de livraison

Verkaufs- und Lieferbedingungen

General terms of sale and delivery

Vente	Verkauf	Contract of sale
Le contrat de vente est conclu sur la base d'une confirmation écrite de la commande ou par la livraison de la marchandise. Aucune compensation n'est accordée lors d'un éventuel retard de livraison.	Der Kaufvertrag gilt erst aufgrund einer schriftlichen Auftragsbestätigung oder mit der Auslieferung der Ware als abgeschlossen. Im Fall einer Lieferverzögerung wird keine Kompensation bewilligt.	The contract of sale shall be deemed concluded upon written confirmation of the order or delivery of the goods only. In case of late delivery, no compensation is given.
Prix et livraison	Preis und Lieferung	Prices and shipment
Les prix sont nets départ usine. Les emballages ne sont pas compris dans le prix.	Die Preise verstehen sich netto ab Werk. Die Verpackung ist im Preis nicht inbegriffen.	All prices are ex factory. Packaging are not included in the prices.
Conditions de paiement	Zahlungsbedingungen	Terms of payment
Sont valables, les conditions de paiement figurant en bas de la facture. Nous nous réservons le droit de propriété de la marchandise livrée jusqu'à réception du paiement intégral de celle-ci.	Die Zahlungsbedingungen sind gültig, welche auf der Rechnung erwähnt sind. Bis zur vollständigen Bezahlung behalten wir uns das Eigentum an der gelieferten Ware vor.	Are valid the terms of payment mentioned on the invoice. We retain title to the goods delivered until full payment thereof.
Réclamations	Beanstandungen	Complaints
Toute réclamation doit être communiquée par écrit dans un délai de 14 jours dès réception de la marchandise. En cas de produits défectueux ou non conformes aux spécifications et tolérances usuelles applicables en la matière, la limite de notre garantie s'étend au remplacement des produits défectueux retournés. Nous déclinons toute responsabilité pour tout autre dommage direct ou indirect ou dommage consécutif que ce soit d'ordre contractuel ou délictuel y compris par négligence ou autre.	Beanstandungen sind innert 14 Tagen seit Empfang der Ware schriftlich anzumelden. Im Fall von defekten Produkten oder Abweichungen von branchenüblichen Spezifikationen und Toleranzen, beschränkt sich die Garantie auf den Ersatz der zurückgesandten Produkte. Wir lehnen jede Haftung für weitere direkte oder indirekte Schäden oder Folgeschäden ab, weder auf Grund vertraglicher oder Verschuldenshaftung einschliesslich Fahrlässigkeit oder anderes.	Any complaints shall be addressed within 2 weeks upon receipt of the goods. In the event that products are defective or do not comply with specifications and tolerances applicable in the relevant industry, the warranty is limited to the replacement of the returned products. We shall not be liable for any other direct or indirect damages or consequential damages whether in contract, tort including negligence or otherwise.
Le for juridique est Moutier Suisse.	Gerichtstand ist Moutier Schweiz.	Sole place of jurisdiction is Moutier Switzerland.

Répertoire des articles
 Artikelverzeichnis
 Index of items

Art N°	Page	Art N°	Page
1820 L	6.10	4278-3	3.29
2300-P	1.03	4330	4.07
2300-R	1.04	4330-S	4.06
2810 R	6.09	4331	4.08
2811 R	6.09	4336-HA	4.09
2815 R	6.09	DHP4336	4.13
2820 R	6.10	4337-HA	4.10
2900-P	1.05	4338	4.20
3010	2.08	4341	4.11
3011	2.09	4361	4.12
3012	2.10	4370-1.3	3.13
3013	2.11	DHD4370-1.5	3.20
3014	2.12	4370-2	3.14
3020	2.13 - 2.15	4370-3	3.15
3023	2.16 - 2.19	DHD4370-3	3.21
3026	2.20 - 2.22	4370-4	3.16
3030	2.23 - 2.25	4370-5	3.17
3680-60	2.04	4370-8	3.18
3680-90	2.05	4375-2.5	3.19
3680-120	2.06	4430	4.14
3690	2.07	4431	4.15
4170-2	3.03	DHP4436	4.18
4170R-2	3.04	4440-5	4.16
4170R-3	3.05	4441	4.17
4170R-4	3.06	DHP4470-3	3.26
4230	4.04	4470-1.5	3.22
4231	4.05	4470-3	3.23
4238	4.19	4472-2	3.24
4270-0.75	3.07	4472-4	3.25
4270-1.5	3.08	4901	4.22
4270-2	3.09	4911	4.21
4270-3	3.10	5101	6.04
4270-5	3.11	5102	6.05
4270-8	3.12	5103	6.06 - 6.07
4278-0.75	3.27	5104	6.08
4278-1.5	3.28		

Alfa tool

SWISS  MADE

Because quality requires precision...

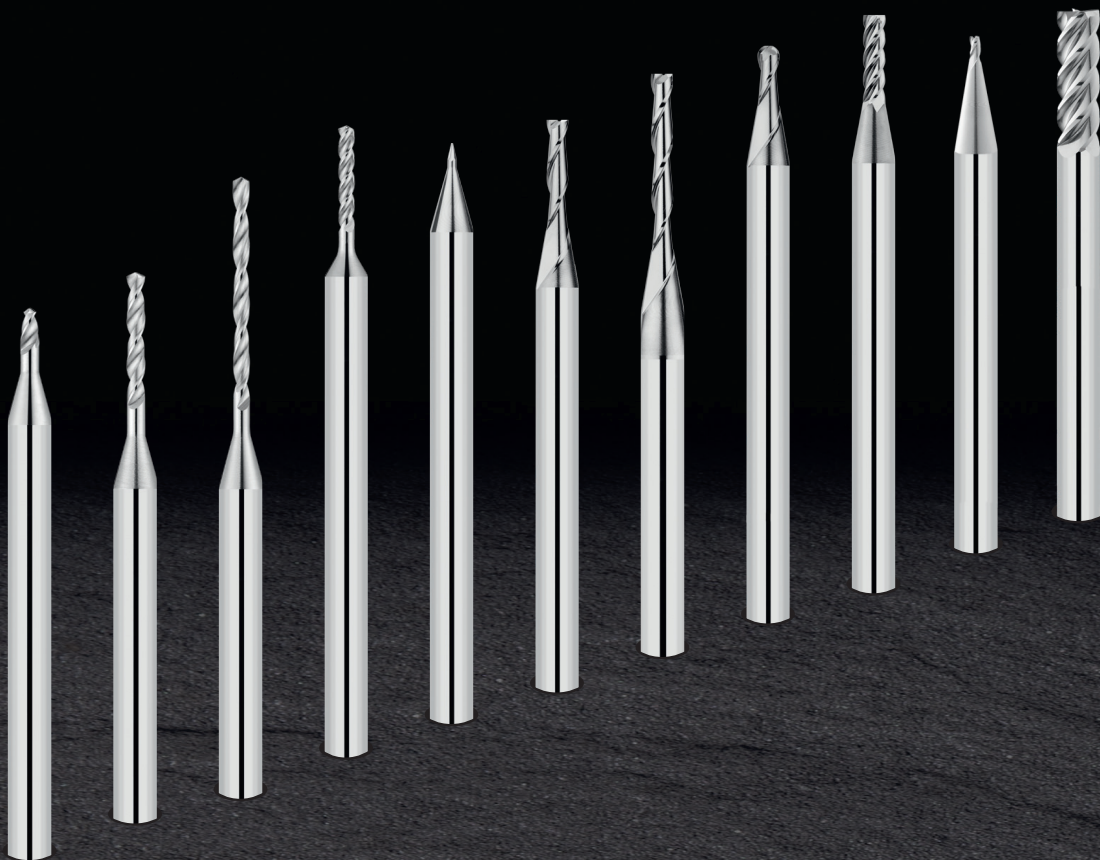

Rue Industrielle 44
CH-2740 Moutier

Tel +41 32 493 73 10
Fax +41 32 493 73 12

www.alfatool.ch
info@alfatool.ch