

BOEHLERIT

Drehkatalog

Member of the LEITZ Group

Turning catalogue



www.boehlerit.com

Schnell, zuverlässig, perfekt und nachhaltig: Hartmetalle und Werkzeuge von Boehlerit setzen Maßstäbe in der Bearbeitung von Metall, Holz, Kunststoff und Verbundwerkstoffen. Die Schneidstoff- und Werkzeugspezialisten aus der Stahlstadt Kapfenberg in der Steiermark lösen durch ihre ‚Nähe zum Stahllabor‘ anspruchsvollste Bearbeitungsaufgaben in Werkstoffen der Zukunft. Schneidstoffe, Halbzeuge und Präzisionswerkzeuge sowie Werkzeugsysteme zum Fräsen, Drehen, Bohren und Umformen sorgen weltweit für Prozesssicherheit und Effizienz. Zum umfassenden Produktspektrum von Boehlerit gehören auch hoch spezialisierte Werkzeuge für die Kurbelwellenbearbeitung sowie für die Hüttentechnik zum Drehschalen, zur Rohr- und Blechbearbeitung sowie der Schwerzerspannung. Eine weitere Stärke von Boehlerit sind Hartmetalle für Konstruktionsteile und für den Verschleißschutz. Auch im Bereich der Beschichtungstechnologie schafft Boehlerit von der weltweit ersten Nano-CVD Anbindungsschicht bis zur härtesten Diamantschicht globale Alleinstellung. Außerdem ist Boehlerit mit seinem langjährigen Know-How in der Metallurgie, der Beschichtungstechnologie und mit modernster Presstechnik ein kompetenter Entwicklungspartner für Toolmaker.

Die Marke Boehlerit wurde 1932 für die Hartmetallfertigung des Stahlherstellers Böhler in Düsseldorf gegründet. 1950 begann der Aufbau einer zweiten Hartmetallfertigung in Kapfenberg/Österreich, am heutigen Hauptsitz der Boehlerit Gruppe. Zwischenzeitlich hat Boehlerit auch Produktions- und Vertriebsstandorte in Deutschland, Spanien, Türkei, Ungarn, Tschechien, Slowakei, Singapur, China, USA, Polen, Brasilien und Mexiko. Mit weiteren exklusiven Vertriebspartnern und gemeinsam mit der Bilz-Gruppe ist Boehlerit auf fast allen Kontinenten, in über 25 Industrieländern, heimisch.

Seit der Privatisierung im Jahr 1991 gehört Boehlerit zum Leitz Firmenverband in Oberkochen/Deutschland und somit zur heutigen Unternehmensgruppe der Familie Brucklacher (Bilz, Boehlerit und Leitz). 770 erfahrene Mitarbeiter (500 am Standort Kapfenberg) erwirtschaften jährlich einen Umsatz von ca. 100 Mio. Euro. Davon investiert Boehlerit 5% direkt in Forschung und Entwicklung. Mit modernsten Analysemethoden und in enger Zusammenarbeit mit Universitäten und Forschungseinrichtungen werden ständig neue Produkte rund um den Schneid- und Verschleißschutzstoff Hartmetall entwickelt. Das macht die Innovationsfabrik Boehlerit zu einem der international führenden Anbieter kundenspezifischer Lösungen und Dienstleistungen in anspruchsvollen Anwendungsbereichen.

Fast, reliable, perfect and sustainable: carbides and tools from Boehlerit are the pacesetters for new standards in the machining of metal, wood, synthetic and composite materials. The cutting materials and tools specialist from the steel town Kapfenberg in Styria has the answers for the most challenging machining tasks for materials of the future with its direct line to the ‚steel lab‘. Reliable and efficient processes are ensured worldwide with cutting materials, semi-finished products, precision tools and tooling systems for milling, turning, drilling and forming. The comprehensive Boehlerit product range includes highly specialised tools for crankshaft machining, tube and pipe machining, sheet metal processing and heavy-duty machining operations in the steel industry. Further Boehlerit strengths include carbides for structural components and for wear-protection. In coating technology, Boehlerit achieved a world first and unique positioning globally with its Nano CVD bonding layer through to the hardest diamond coatings. Added to this, Boehlerit is the expert development partner for toolmakers with its unrivalled know-how and many years of mastery in metallurgy, coatings systems and the latest pressing technologies.

The Boehlerit brand was established in 1932 for the carbide production of the Böhler Steelworks in Düsseldorf, Germany. A second carbide production centre was established at Kapfenberg/Austria in 1950, at what is now the world headquarters of the Boehlerit Group. Boehlerit today has production and sales locations in Germany, Spain, Turkey, Hungary, the Czech Republic, Slovakia, Singapore, China, the USA, Poland, Brazil and Mexico. Boehlerit is at home on virtually every continent and in 25 leading industrial nations working hand-in-hand with exclusive sales partners and its partners in the Bilz Group.

Since privatization in 1991, Boehlerit has been a part of the Leitz Corporate Group in Oberkochen/Germany and is thus a part of the group of companies owned by the Brucklacher family (Bilz, Boehlerit and Leitz). The company employs 770 experienced employees (500 in Kapfenberg alone). 5 % of its annual turnover of around 100 million euros is invested directly in research and development every year. Using state-of-the-art analytical methods and profiting from its close cooperation with universities and research institutes, Boehlerit generates a constant flow of new products and solutions revolving around carbides and their use for cutting and wear-protection. All of this has made the innovation factory Boehlerit one of the world's leading providers of customised solutions and services for industries with the most demanding applications.



Kapfenberg in der Steiermark / **ÖSTERREICH** in Styria / **AUSTRIA**

Drehen	Turning	
Programmübersicht	Range of tools	6
Spanformstufengeometrien	Chip groove geometries	16
Schnitttiefen der Spanformstufengeometrien	Depth of cut for chip groove geometries	24
Sortenübersicht, Schneidstoffsorten	Grade overview, cutting materials	25
ISO-Bezeichnungssysteme	ISO-designation systems	28
Wendeschneidplatten	Indexable inserts	34
Klemmhalter	Tool holders	63
Technische Hinweise	Technical hints	100
Dreh-Bohr-Werkzeug Pentatec®	Turning-Drilling-Tool Pentatec®	
Fünf Bearbeitungsoperationen, ein Werkzeug	Five machining operations, one tool	121
Technische Hinweise	Technical hints	122
Bezeichnungssystem	Designation system	124
Halterprogramm	Tool holders	125
Wendeschneidplatten	Indexable inserts	126
Schnittparameter	Cutting parameters	128
Gewindedrehen	Thread Turning	
Wendeschneidplatten	Indexable inserts	137
Klemmhalter	Tool holders	152
Technische Hinweise	Technical hints	154
Anhang	Attachment	
Farbleitsystem	Colour identification system	163
Werkstoff-Vergleichstabelle	Comparison of material standards	164
Vergleich ISO- zu ANSI-Kennzeichnung	Comparison ISO- and ANSI-designation	172
Härte Vergleichstabelle	Hardness comparison table	175

Nachdruck, auch auszugsweise, ist nur mit unserer Zustimmung gestattet. Alle Rechte vorbehalten. Irrtümer, Satz- oder Druckfehler berechtigen nicht zu irgendwelchen Ansprüchen. Abbildungen, Ausführungen und Maße entsprechen dem neuesten Stand bei Herausgabe dieses Kataloges. Technische Änderungen müssen vorbehalten sein. Die bildliche Darstellung der Produkte muss nicht in jedem Falle und in allen Einzelheiten dem tatsächlichen Aussehen entsprechen.



This publication may not be reprinted in whole or part without our express permission. All right reserved. No rights may be derived from any errors in content or from typographical or typesetting errors. Diagrams, features and dimensions represent the current status on the date of issue of this catalogue. We reserve the right to make technical changes. The visual appearance of the products may not necessarily correspond to the actual appearance in all cases or in every detail.

Drehen
Turning

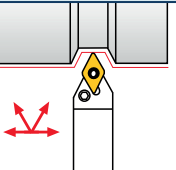
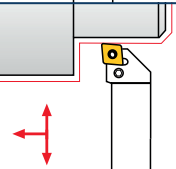
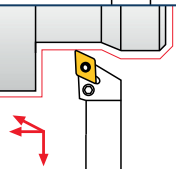
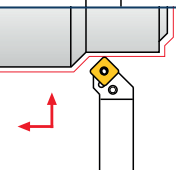
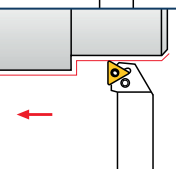
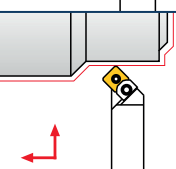
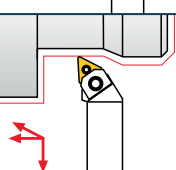

6	Programmübersicht Range of tools
6	Werkzeuge und Wendeschneidplatten für die Außenbearbeitung Tools and indexable inserts for external machining
14	Werkzeuge und Wendeschneidplatten für die Innenbearbeitung Tools and indexable inserts for internal machining
16	Spanformstufengeometrien Chip groove geometries
24	Schnitttiefe der Spanformgeometrien Depth of cut for chipbreaker
25	Sortenübersicht Grade overview
28	ISO-Bezeichnungssysteme ISO-designation systems
34	Wendeschneidplatten Indexable inserts
63	Klemmhalter Tool holders
100	Technische Hinweise Technical hints
100	Klemmhalter-Spannsysteme Tool holder – clamping systems
101	Wahl des Spannsystems Selecting a clamping system
102	Wahl der Werkzeuge für die Innenbearbeitung Selecting tools for internal machining
103	Wahl der Wendeplattengröße Selecting the indexable insert size
104	Wahl der Wendeplattenform Selecting the indexable insert shape
106	Schlichtbearbeitung Finishing
108	Formeln für die Drehbearbeitung Formulas for machining work
109	Maßnahmen bei Drehproblemen Options against machining problems
110	Schnittwertempfehlungen Cutting data recommendations

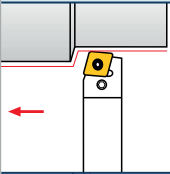
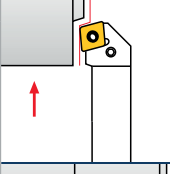
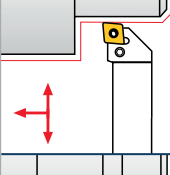
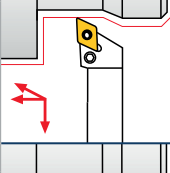
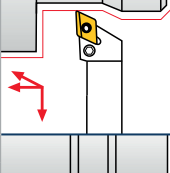
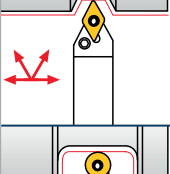
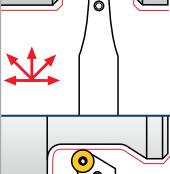
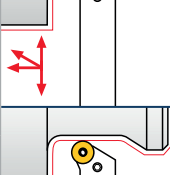
Schnittrichtung Cutting direction	Anstellwinkel Setting angle	Werkzeug Tool	Bestellbezeichnung Ordering Code	Seiten Pages
	72,5°	Klemmhalter Tool holder Wendeplatte Indexable inserts	BM51576 XCGT...	89
	95°	Klemmhalter Tool holder Wendeplatte Indexable inserts	DCLNR/L CN...	64
	93°	Klemmhalter Tool holder Wendeplatte Indexable inserts	DDJNR/L DN...	64
	45°	Klemmhalter Tool holder Wendeplatte Indexable inserts	DSSNR/L SN...	64
	90°	Klemmhalter Tool holder Wendeplatte Indexable inserts	DTJNR/L 16 TN...	65
	95°	Klemmhalter Tool holder Wendeplatte Indexable inserts	DWLNRL WN...	65
	45°	Klemmhalter Tool holder Wendeplatte Indexable inserts	MSSNR/L SN...	66
	93°	Klemmhalter Tool holder Wendeplatte Indexable inserts	MTJNR/L TN...	66
	95°	Klemmhalter Tool holder Wendeplatte Indexable inserts	MWLNRL WN...	67

Schnitttrichtung Cutting direction	Anstellwinkel Setting angle	Werkzeug Tool	Bestellbezeichnung Ordering Code	Seiten Pages
	75°	Klemmhalter Tool holder Wendeplatte Indexable inserts	PCBNR/L CN...	68
	75°	Klemmhalter Tool holder Wendeplatte Indexable inserts	PCKNR/L CN...	68
	95°	Klemmhalter Tool holder Wendeplatte Indexable inserts	PCLNR/L CN...	68
	93°	Klemmhalter Tool holder Wendeplatte Indexable inserts	PDJNR/L DN...	69
	93°	Klemmhalter Tool holder Wendeplatte Indexable inserts	PDJNR/L 14 DN... 14...	69
	63°	Klemmhalter Tool holder Wendeplatte Indexable inserts	PDNNR/L DN...	69
	-	Klemmhalter Tool holder Wendeplatte Indexable inserts	PRDCN RC...	70
	-	Klemmhalter Tool holder Wendeplatte Indexable inserts	PRGCR/L RC...	70
	-	Klemmhalter Tool holder Wendeplatte Indexable inserts	PRSCR/L RC...	70

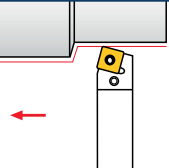
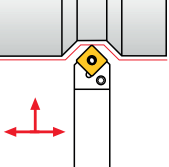
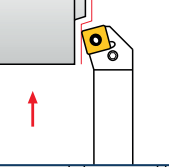
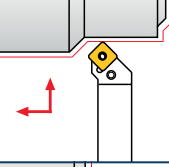
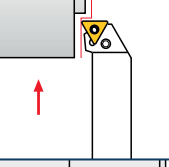
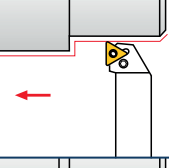
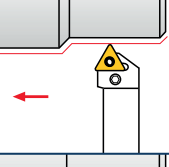
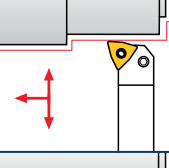
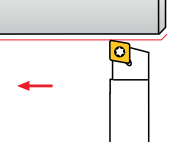
Schnittrichtung Cutting direction	Anstellwinkel Setting angle	Werkzeug Tool	Bestellbezeichnung Ordering Code	Seiten Pages
	75°	Klemmhalter Tool holder Wendeplatte Indexable inserts	PSBNR/L SN...	71
	45°	Klemmhalter Tool holder Wendeplatte Indexable inserts	PSDNN SN...	71
	75°	Klemmhalter Tool holder Wendeplatte Indexable inserts	PSKNR/L SN...	71
	45°	Klemmhalter Tool holder Wendeplatte Indexable inserts	PSSNR/L SN...	72
	90°	Klemmhalter Tool holder Wendeplatte Indexable inserts	PTFNR/L TN...	73
	90°	Klemmhalter Tool holder Wendeplatte Indexable inserts	PTGNR/L TN...	73
	60°	Klemmhalter Tool holder Wendeplatte Indexable inserts	PTTNR/L TN...	73
	95°	Klemmhalter Tool holder Wendeplatte Indexable inserts	PWLNRL/L WN...	74
	90°	Klemmhalter Tool holder Wendeplatte Indexable inserts	SCACR/L CC...	75

Schnittrichtung Cutting direction	Anstellwinkel Setting angle	Werkzeug Tool	Bestellbezeichnung Ordering Code	Seiten Pages
	45°	Klemmhalter Tool holder Wendeplatte Indexable inserts	SCDCL CC...	75
	90°	Klemmhalter Tool holder Wendeplatte Indexable inserts	SCFCR/L CC...	75
	90°	Klemmhalter Tool holder Wendeplatte Indexable inserts	SCGCR/L CC...	76
	95°	Klemmhalter Tool holder Wendeplatte Indexable inserts	SCLCR/L CC...	76
	50°	Klemmhalter Tool holder Wendeplatte Indexable inserts	SCMCN CC...	76
	75°	Klemmhalter Tool holder Wendeplatte Indexable inserts	SCRCL/L CC...	77
	45°	Klemmhalter Tool holder Wendeplatte Indexable inserts	SCSCR/L CC...	77
	90°	Klemmhalter Tool holder Wendeplatte Indexable inserts	SDACR/L DC...	78
	107,5°	Klemmhalter Tool holder Wendeplatte Indexable inserts	SDHCR/L DC...	78

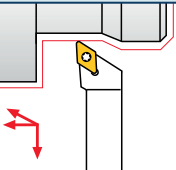
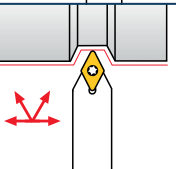
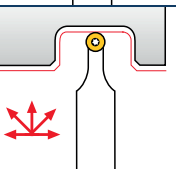
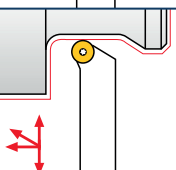
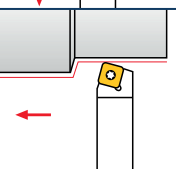
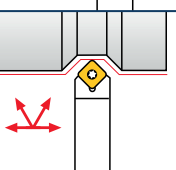
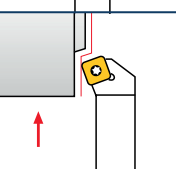
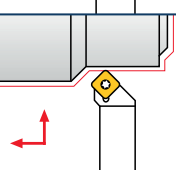
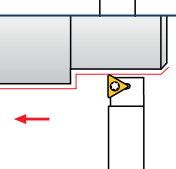
Schnittrichtung Cutting direction	Anstellwinkel Setting angle	Werkzeug Tool	Bestellbezeichnung Ordering Code	Seiten Pages
	93°	Klemmhalter Tool holder Wendepplatte Indexable inserts	SDJCR/L DC...	78
	62,5°	Klemmhalter Tool holder Wendepplatte Indexable inserts	SDNCN DC...	79
	-	Klemmhalter Tool holder Wendepplatte Indexable inserts	SRDCN RC...	80
	-	Klemmhalter Tool holder Wendepplatte Indexable inserts	SRGCR/L RC...	80
	75°	Klemmhalter Tool holder Wendepplatte Indexable inserts	SSBCR/L SC...	81
	45°	Klemmhalter Tool holder Wendepplatte Indexable inserts	SSDCN SC...	81
	75°	Klemmhalter Tool holder Wendepplatte Indexable inserts	SSKCR/L SC...	81
	45°	Klemmhalter Tool holder Wendepplatte Indexable inserts	SSSCR/L SC...	82
	90°	Klemmhalter Tool holder Wendepplatte Indexable inserts	STACR/L TC...	83

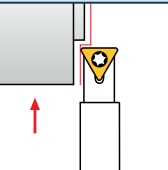
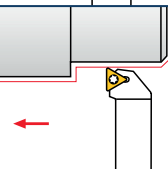
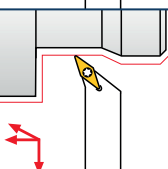
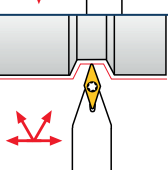
Schnittrichtung Cutting direction	Anstellwinkel Setting angle	Werkzeug Tool	Bestellbezeichnung Ordering Code	Seiten Pages
	90°	Klemmhalter Tool holder Wendeplatte Indexable inserts	STCCN TC...	83
	90°	Klemmhalter Tool holder Wendeplatte Indexable inserts	STFCR/L TC...	83
	90°	Klemmhalter Tool holder Wendeplatte Indexable inserts	STGCR/L TC...	84
	107,5°	Klemmhalter Tool holder Wendeplatte Indexable inserts	SVHBR/L VB...	85
	107,5°	Klemmhalter Tool holder Wendeplatte Indexable inserts	SVHCR/L VC...	85
	93°	Klemmhalter Tool holder Wendeplatte Indexable inserts	SVJBR/L VB...	86
	93°	Klemmhalter Tool holder Wendeplatte Indexable inserts	SVJCR/L VC...	86
	72,5°	Klemmhalter Tool holder Wendeplatte Indexable inserts	SVVBN VB...	87
	72,5°	Klemmhalter Tool holder Wendeplatte Indexable inserts	SVVCN VC...	87

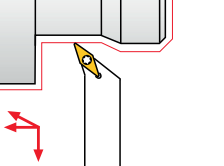
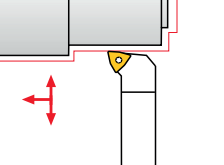
Schnittichtung Cutting direction	Anstellwinkel Setting angle	Werkzeug Tool	Bestellbezeichnung Ordering Code	Seiten Pages
	100°	Klemmhalter Tool holder	SVZCR/L	87
		Wendepplatte Indexable inserts	VC...	
	95°	Klemmhalter Tool holder	SWLCR/L	88
		Wendepplatte Indexable inserts	WC...	

Schnittrichtung Cutting direction	Anstellwinkel Setting angle	Werkzeug Tool	Bestellbezeichnung Ordering Code	Seiten Pages
	95°	Klemmhalter Tool holder Wendeplatte Indexable inserts	PCLNR/L CN...	90
	95°	Klemmhalter Tool holder Wendeplatte Indexable inserts	29629/29529 CN...	90
	93°	Klemmhalter Tool holder Wendeplatte Indexable inserts	PDUNR/L DN...	91
	93°	Klemmhalter Tool holder Wendeplatte Indexable inserts	PDUNR/L 14 DN...	91
	75°	Klemmhalter Tool holder Wendeplatte Indexable inserts	PSKNR/L SN...	92
	90°	Klemmhalter Tool holder Wendeplatte Indexable inserts	PTFNR/L TN...	92
	95°	Klemmhalter Tool holder Wendeplatte Indexable inserts	PWLNRL/L WN...	93
	90°	Klemmhalter Tool holder Wendeplatte Indexable inserts	SCFCR/L CC...	94
	95°	Klemmhalter Tool holder Wendeplatte Indexable inserts	SCLCR/L CC...	94
	107,5°	Klemmhalter Tool holder Wendeplatte Indexable inserts	SDQCR/L DC...	95

Schnittrichtung Cutting direction	Anstellwinkel Setting angle	Werkzeug Tool	Bestellbezeichnung Ordering Code	Seiten Pages
	93°	Klemmhalter Tool holder Wendeplatte Indexable inserts	SDUCR/L DC...	95
	90°	Klemmhalter Tool holder Wendeplatte Indexable inserts	STFCR/L TC...	96
	95°	Klemmhalter Tool holder Wendeplatte Indexable inserts	SVLCR/L ...	96
	5°	Klemmhalter Tool holder Wendeplatte Indexable inserts	SVOCR/L ...	96
	107,5°	Klemmhalter Tool holder Wendeplatte Indexable inserts	SVQCR/L VC...	97
	93°	Klemmhalter Tool holder Wendeplatte Indexable inserts	SVUBR/L VB...	97
	93°	Klemmhalter Tool holder Wendeplatte Indexable inserts	SVUCR/L VC...	97
	95°	Klemmhalter Tool holder Wendeplatte Indexable inserts	SWLCR/L WC...	98
	92°	Klemmhalter Tool holder Wendeplatte Indexable inserts	S74P TP...	99

<p>Im "Spankanal" optimierte Spanleitstufe mit besonders weichem Schnitt Chip breaker optimised in the chip channel; remarkably soft cut</p>		<p>Geringere Reibung ergibt geringere Neigung zum Kolkverschleiß und daher längere Standzeiten</p>	<p>Reduced friction therefore less cratering, resulting in prolonged tool life</p>
<p>Größe des Eckenradius und Anwendungsbereiches mitgepresst Corner radius dimension and application range are pressed along in the process</p>		<p>Einfache Zuordnung der Wendeplatten</p>	<p>Simple allocation of indexable inserts</p>
<p>Neuentwickelte Spanformer Newly developed chip breaker</p>		<p>Optimaler Spanbruch</p>	<p>Optimized chip breaking</p>
<p>Schneidkantenbereich in der Mitte stabilisiert, optimierte Mikrogeometrie Cutting edge area stabilised in the middle; optimised micro-geometry</p>		<p>Keine Ausbrüche bei Spanschlag - Drehen gegen die Schulter</p>	<p>No breakage at chip impact - turning against the shoulder</p>
<p>Spanschlag-Protektor Chip impact protector</p>		<p>Keine Ausbrüche durch Spanschlag beim Drehen gegen die Schulter</p>	<p>No chippings of the cutting edge caused by chip impact when turning against the shoulder</p>
<p>Spezielle Spangeometrie mit auf Kleinteile abgestimmten Eckenradien Special chip geometry with corner radius for little parts</p>		<p>Guter Spanbruch und weicher Schnitt</p>	<p>Good chip breakage and smooth cut</p>
<p>Positive Makrogeometrie und scharfe Mikrogeometrie Positive macrogeometry and sharp microgeometry</p>		<p>Guter Spanbruch auf schwerzerspanbaren Werkstoffen z.B.: (Superlegierungen)</p>	<p>Good chip breaking characteristics on materials that are notoriously difficult to machine (superalloys)</p>
<p>Optimierte Gradientenhardtmetalle Optimised gradient carbides</p>		<p>Speziell auf den jeweiligen Anwendungsfall abgestimmte Hartmetallsorten für besondere Sicherheit</p>	<p>Carbide gradient grades tailored to specific applications for extra-high safety levels</p>
<p>Dicke MT-CVD-Schicht Thick MT-CVD layer</p>		<p>Bewährte Nanolockverbindungen. Besonders dicke MT-CVD-Schichten bei LCP15T und LCP25T gewährleisten Standzeitsteigerungen bis zu 60 %</p>	<p>Proven Nanolock compound. LCP15T and LCP25T with especially thick MT-CVD layer allow 60 % increase of tool life</p>

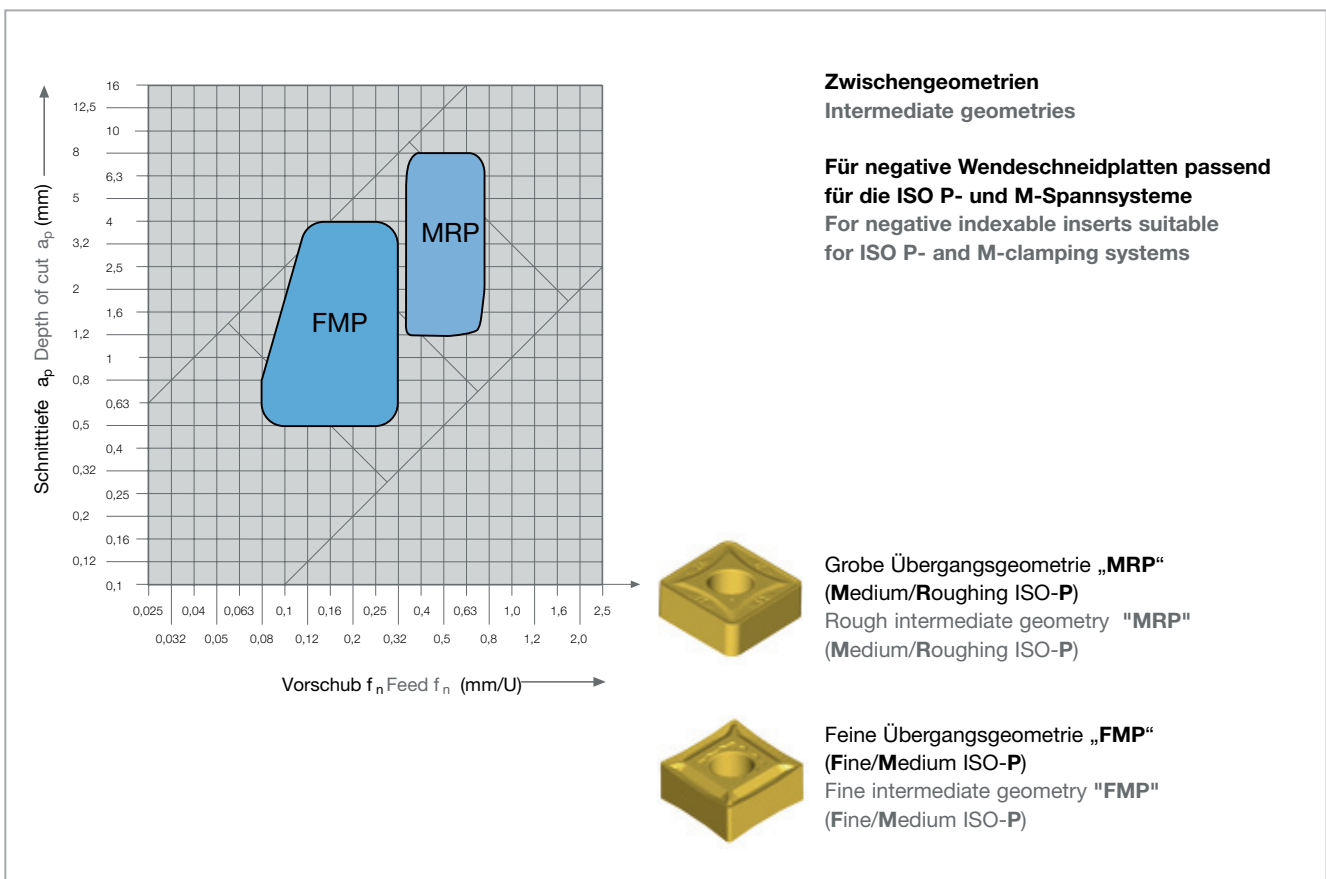
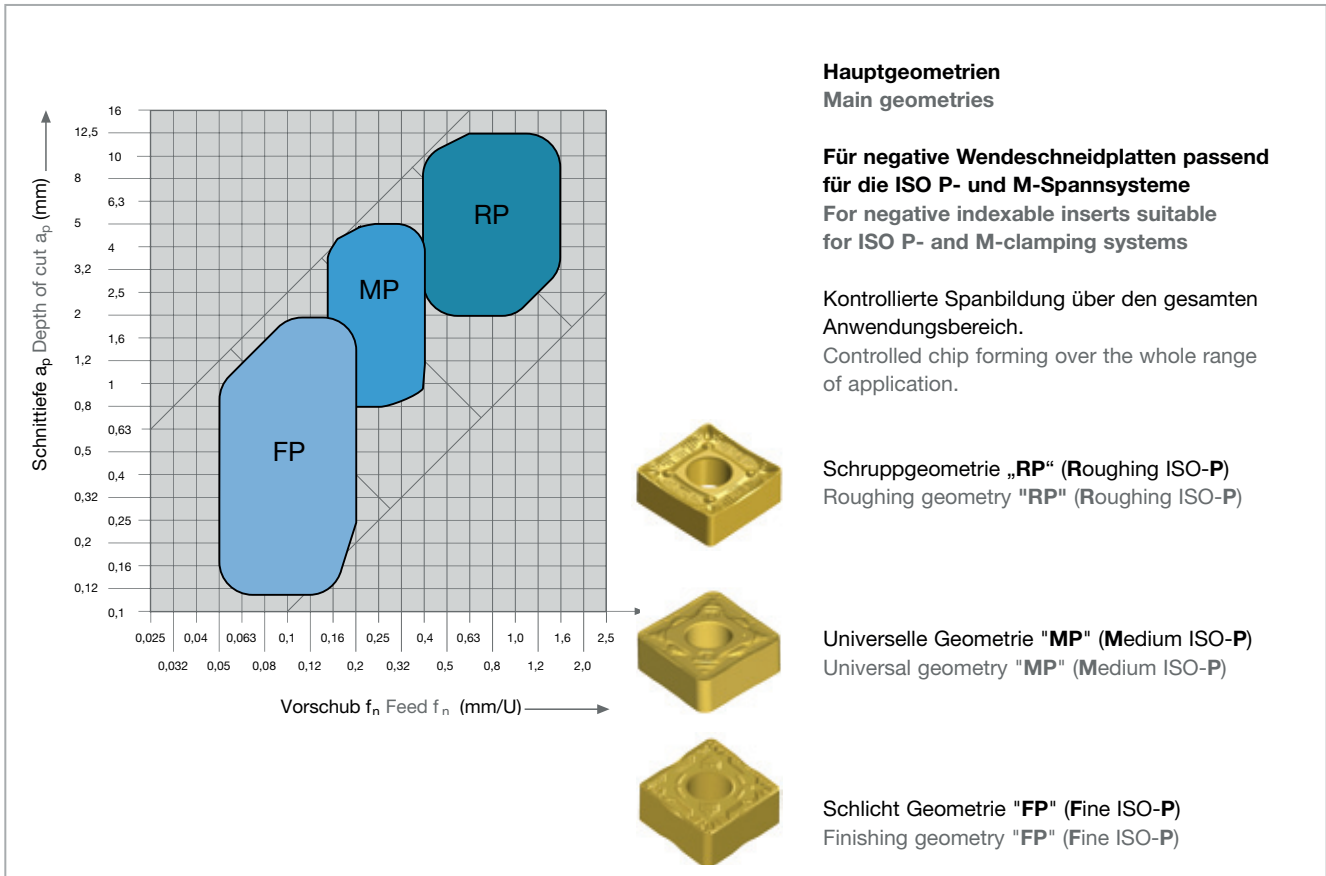

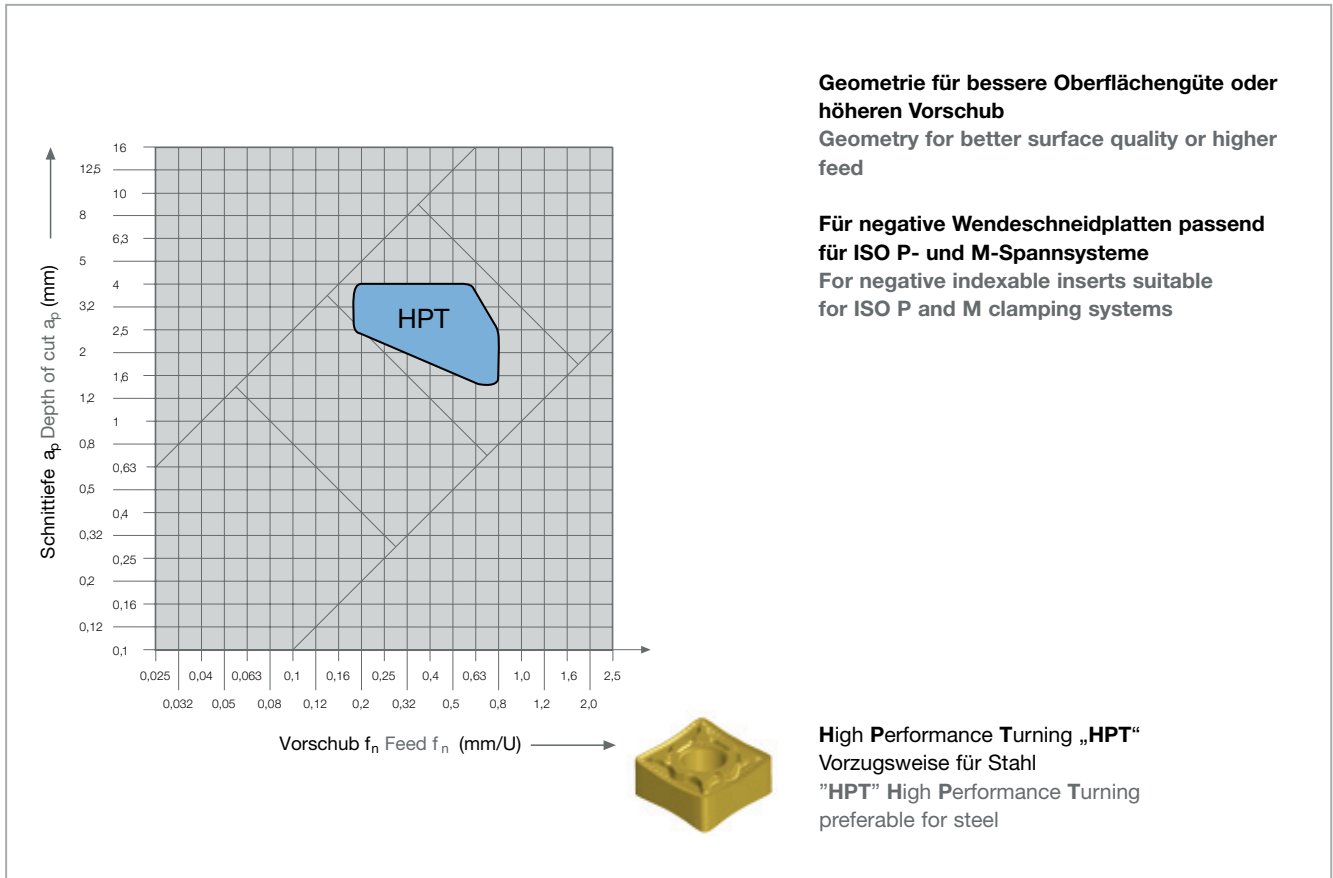

Ra - Werte / Ra - Values **CNMG 120408 ISO / HPT / Wiper**

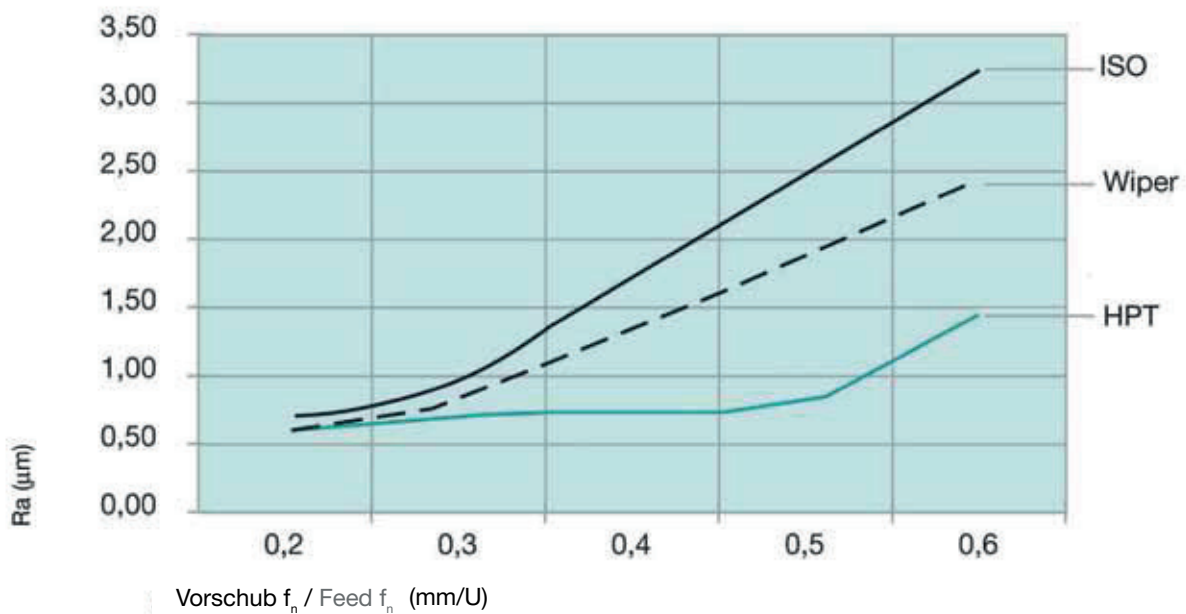

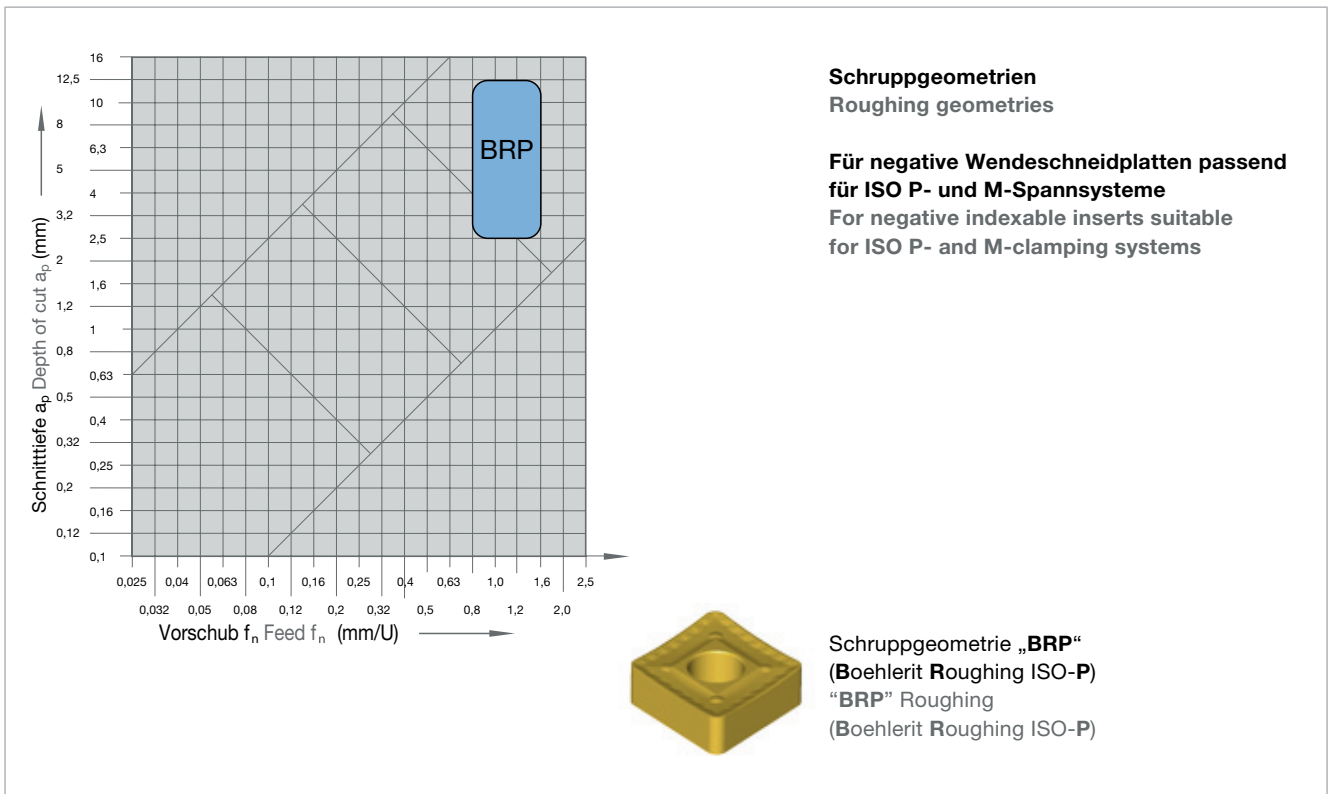
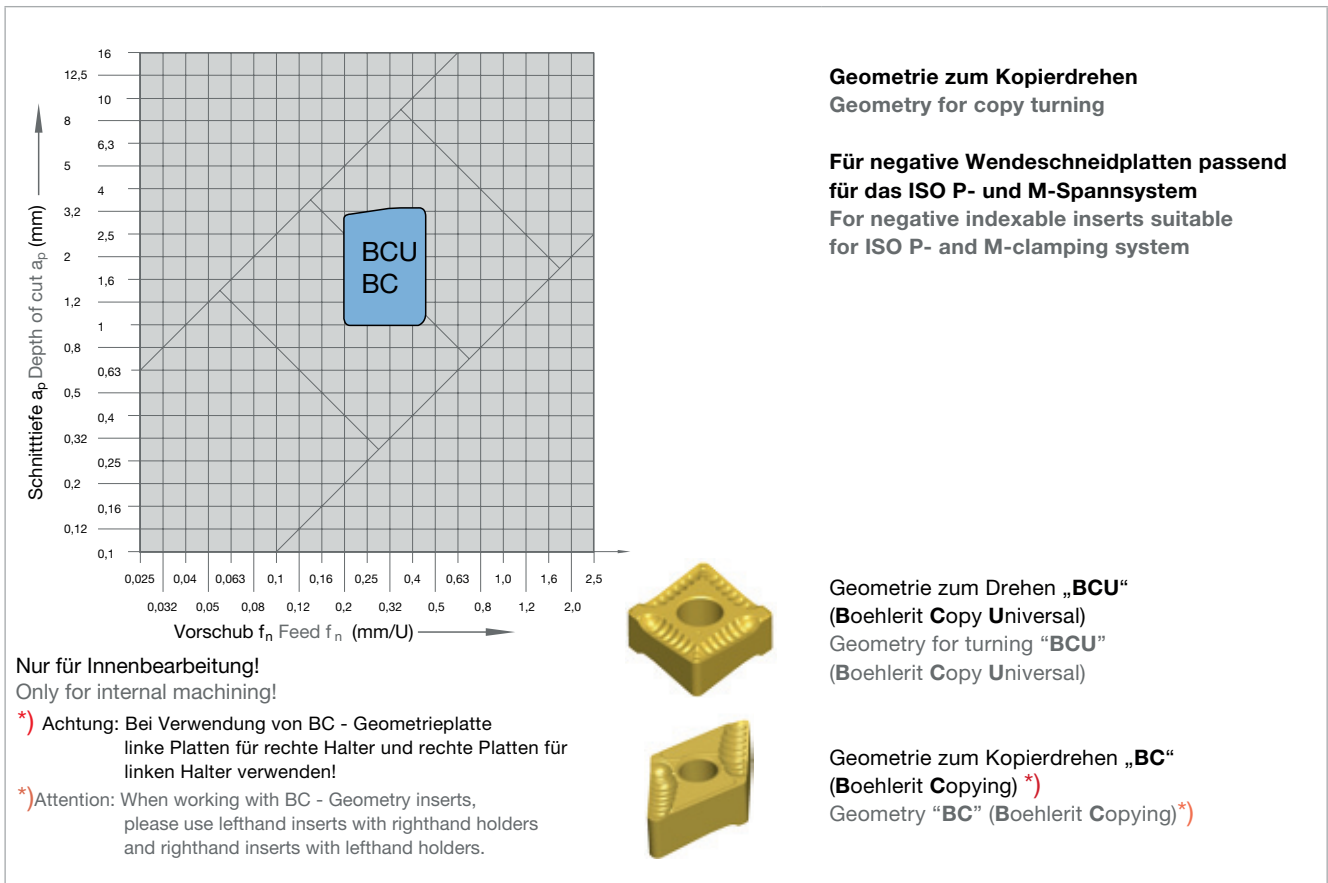

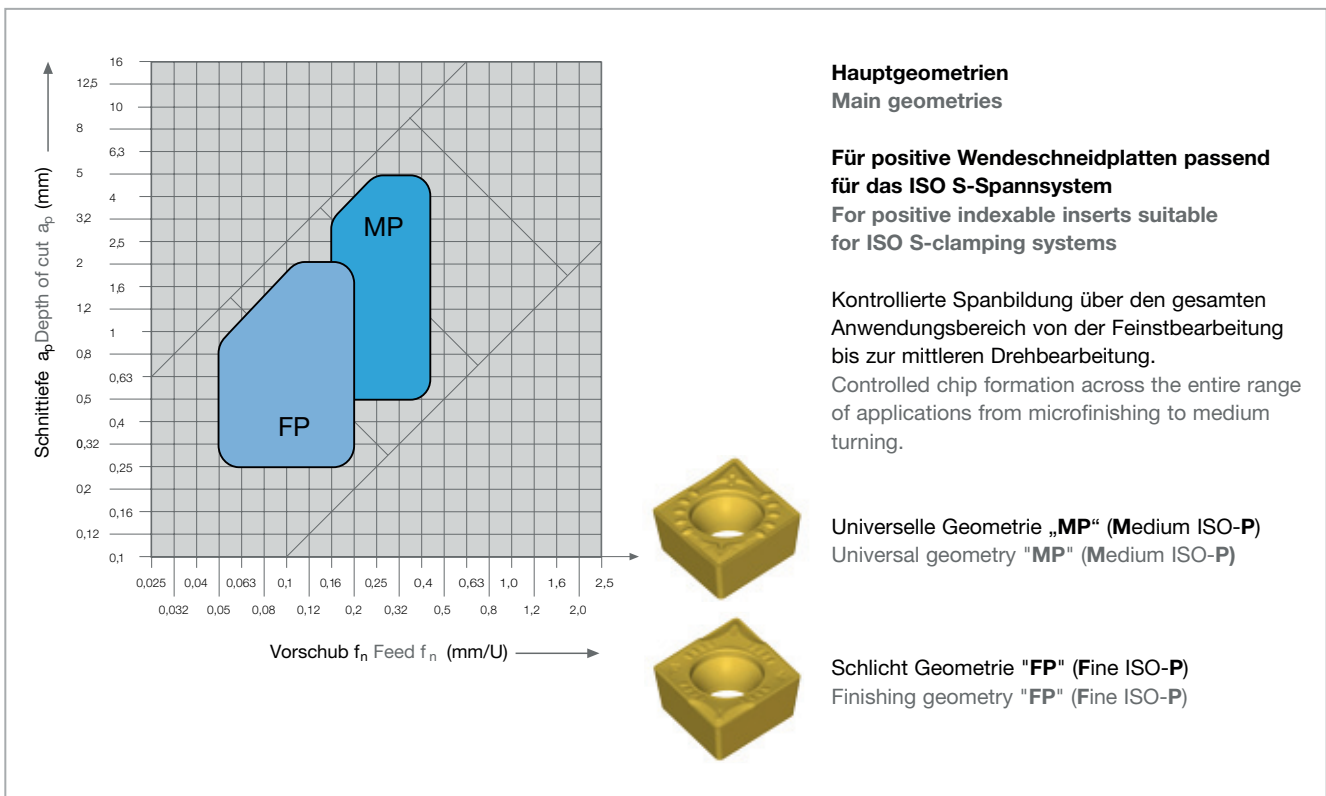
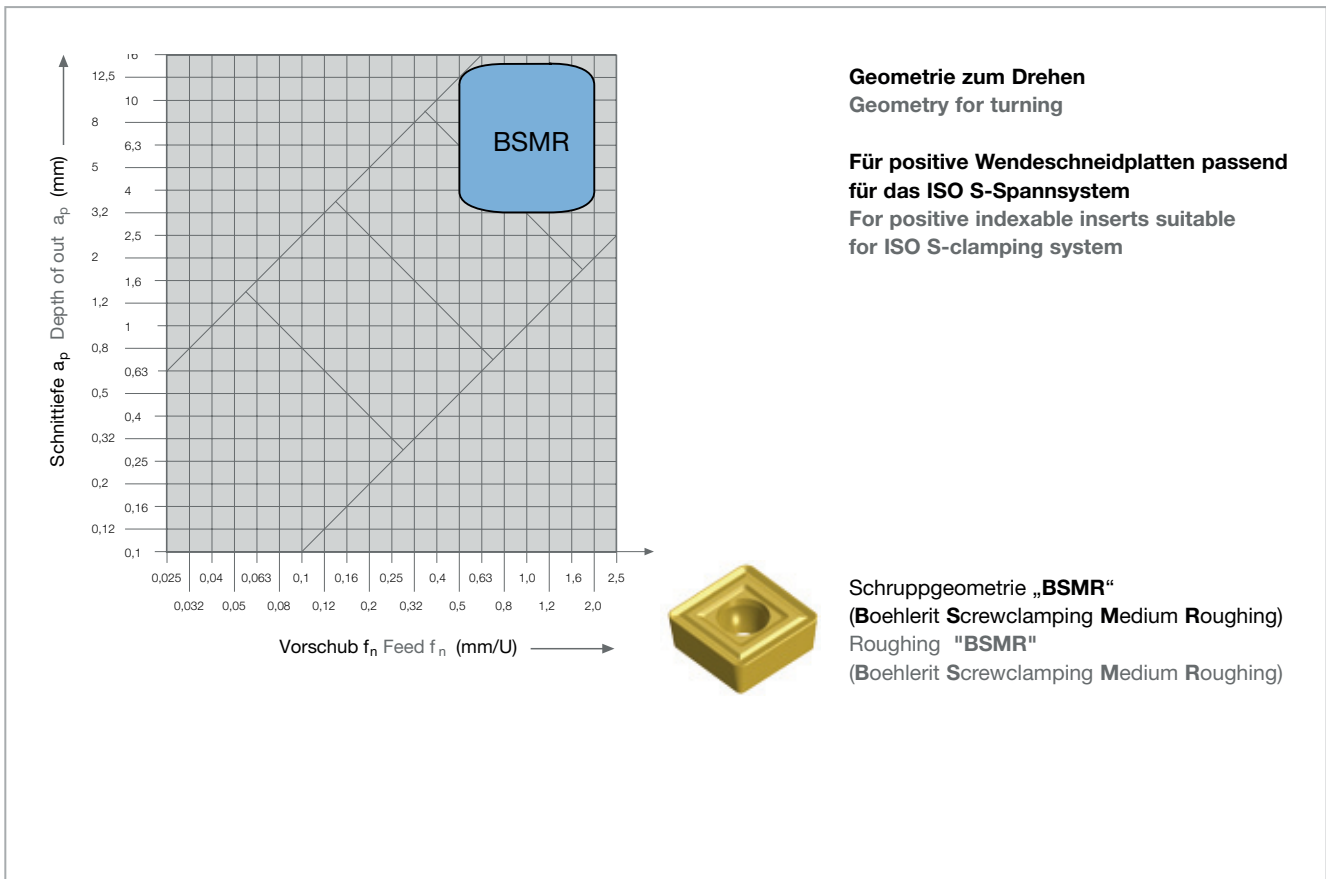

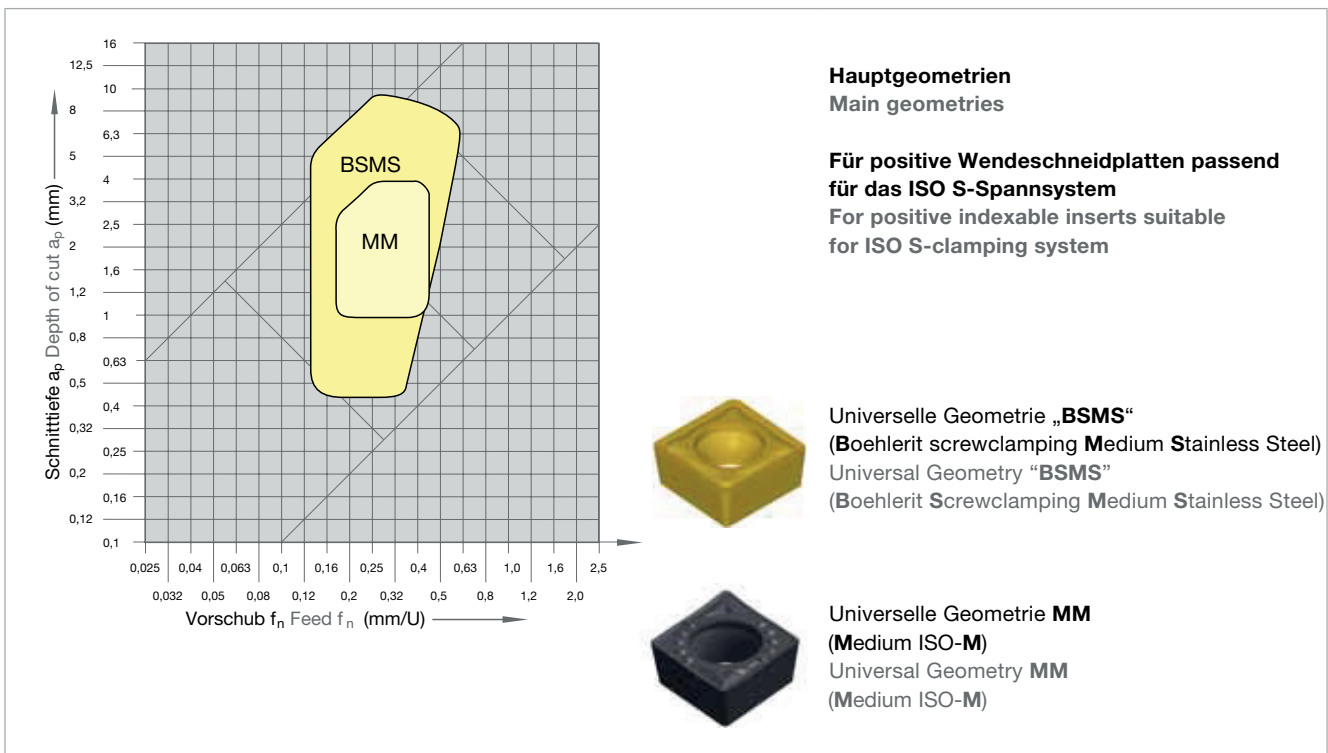
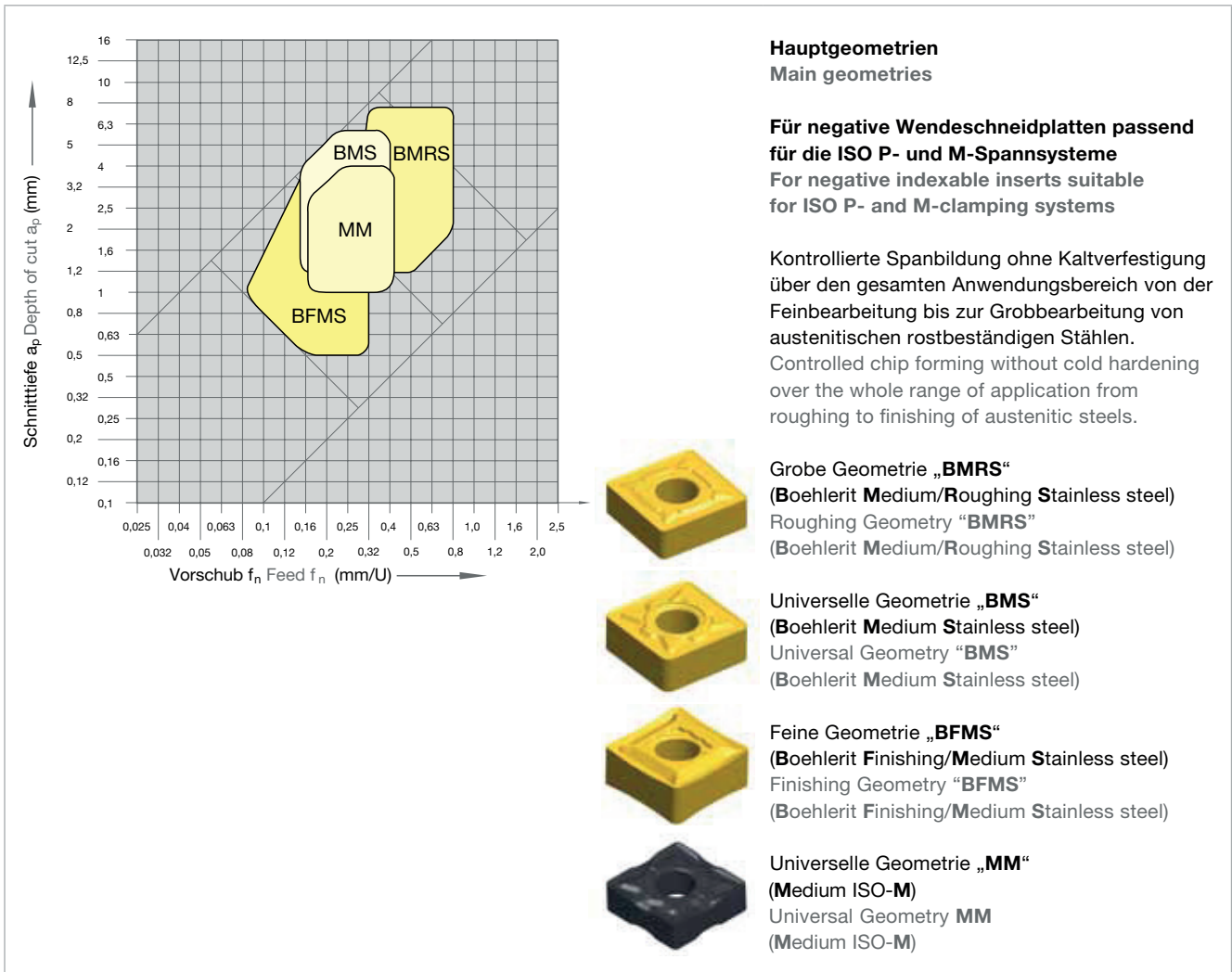

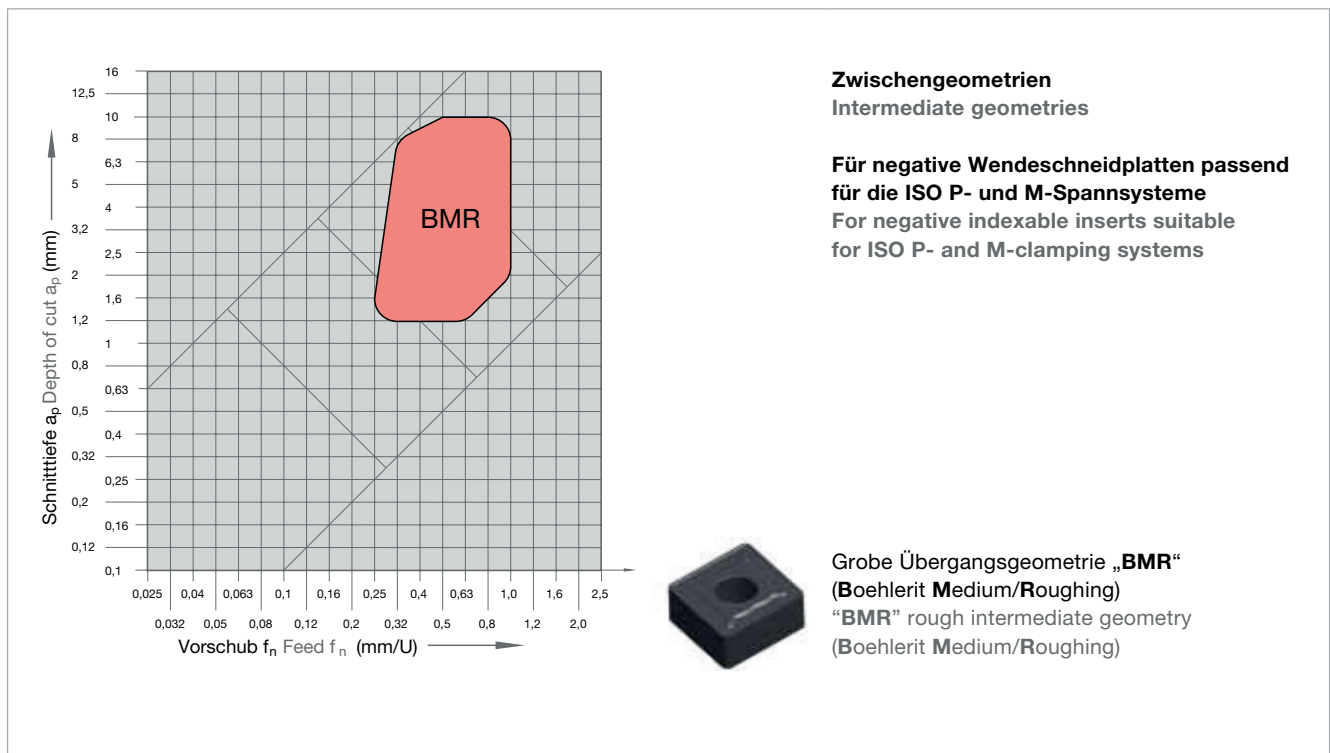
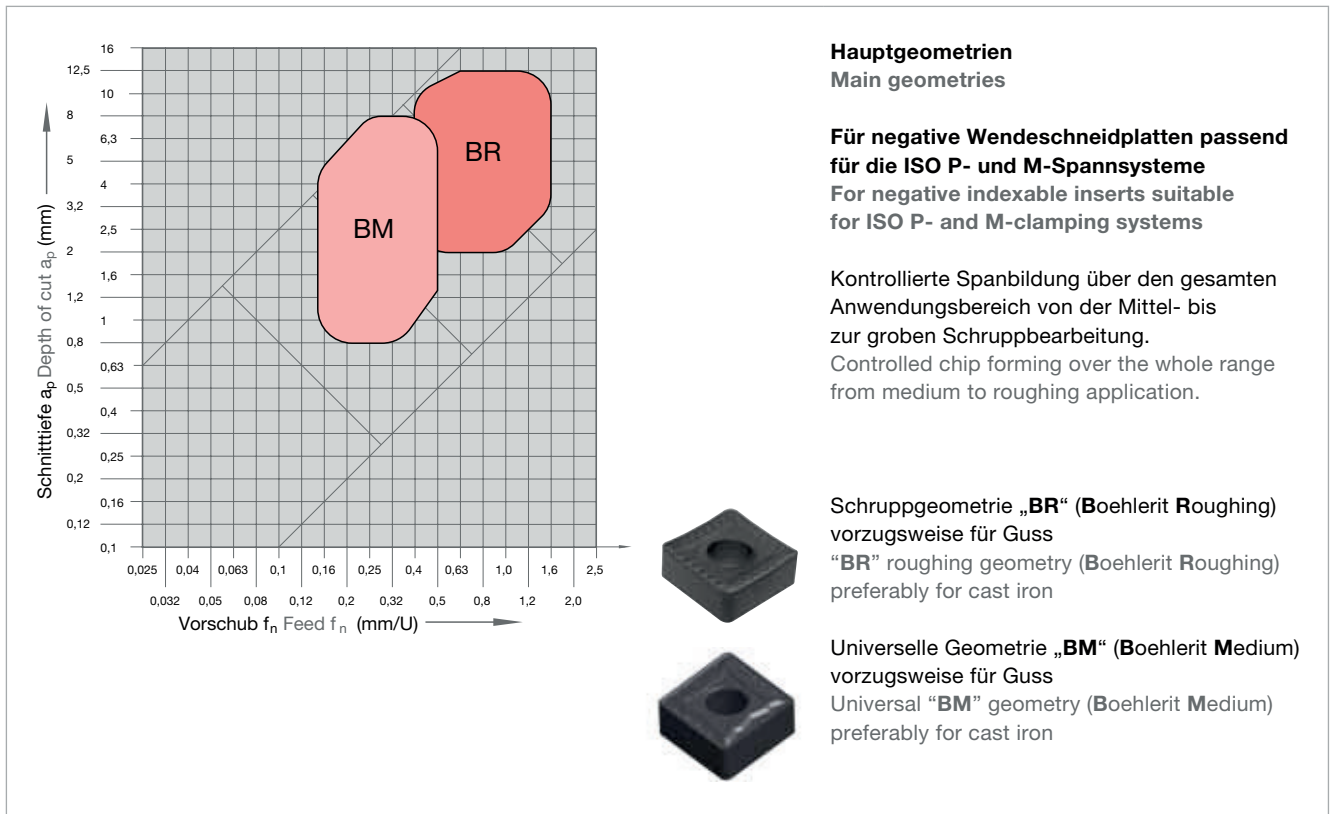

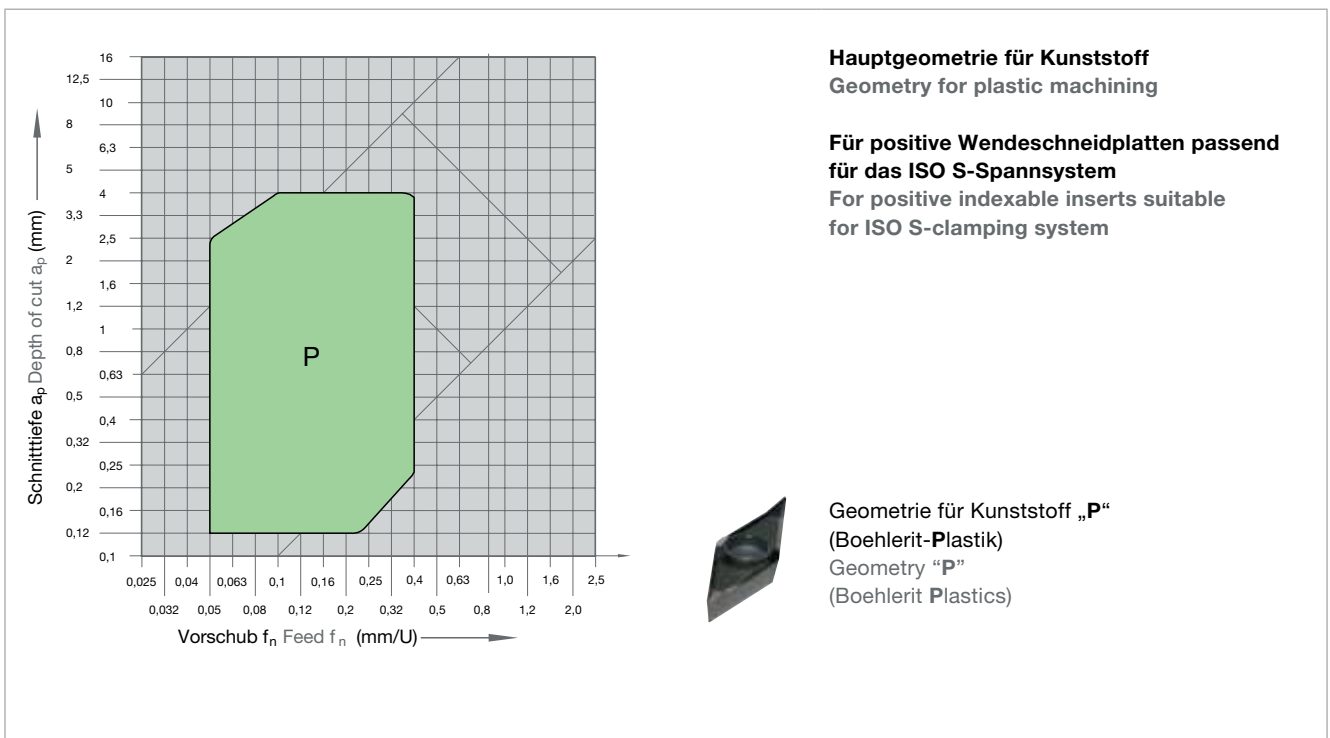
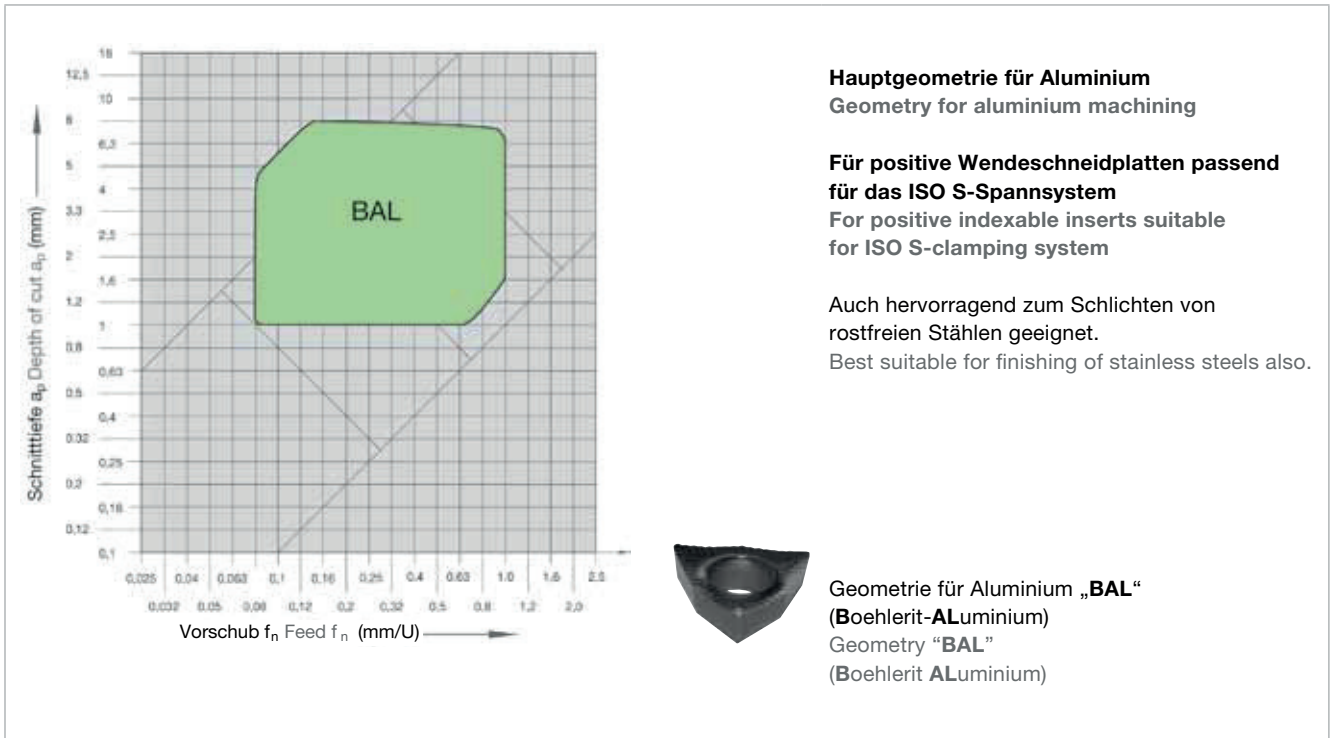

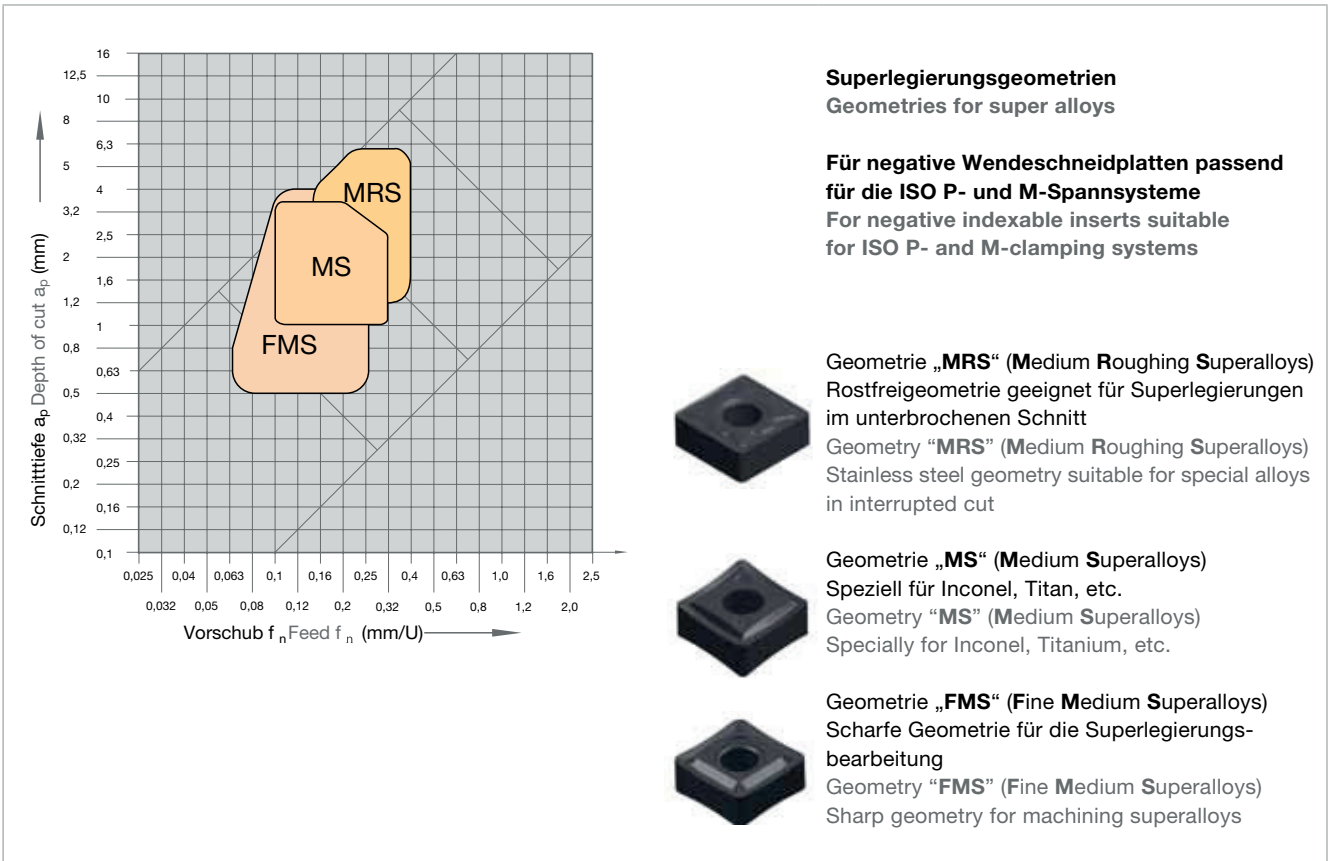



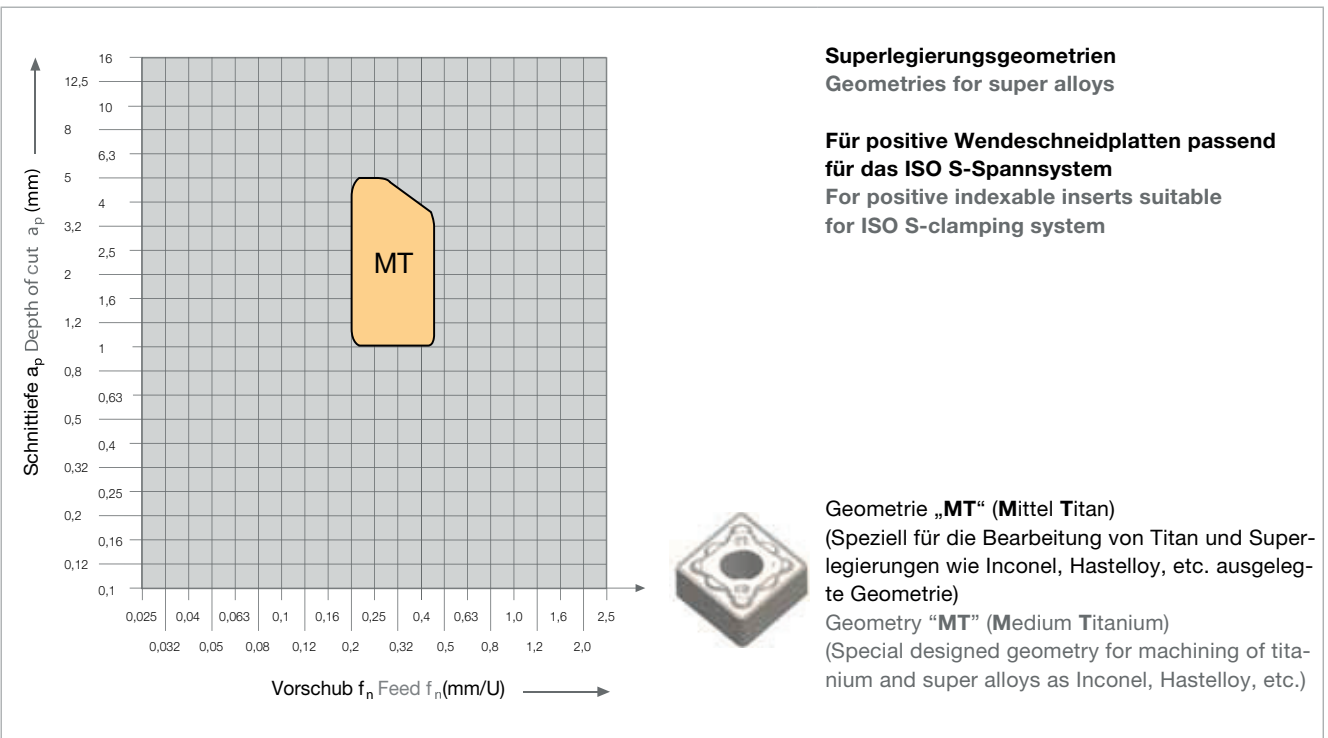

















Spanformstufengeometrien für Titan und Superlegierungen
Chip groove geometries for titanium and super alloys

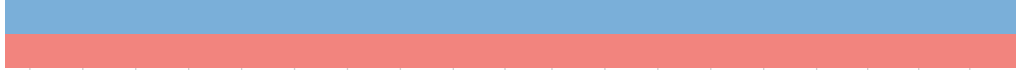

	a_p mm	0,5	1	1,5	2	2,5	3	3,5	4	4,5	5	5,5	6	6,5	7	7,5	8	8,5	9	9,5	10	11	12		
Schlichten f (mm/U) Finishing f (mm/rev)	0,05–0,2			FP																					
	0,1–0,3									FMP															
	0,1–0,3									FMS															
	0,1–0,3									BFMS															
Mittlere Bearbeitung f (mm/U) Medium machining f (mm/rev)	0,2–0,4									MS															
	0,15–0,4									MM															
	0,16–0,4									MP															
	0,16–0,4									BMS															
	0,2–0,45											MT													
	0,2–0,5											MRS													
	0,15–0,4											BM													
	0,2–0,8									HPT															
	0,2–0,5																					BSMS			
	0,15–0,65																			BAL					
	0,1–1,0																			P					
	0,2–0,45									BC BCU															
0,35–0,6									BMRS																
Schruppen f (mm/U) Roughing f (mm/rev)	0,5–2,0	BSMR																							
	0,32–0,8													MRP BMR											
	0,4–1,6	RP BR, BRP																							

Sorte Grade	ISO	Anwendungsbereich Application range	Werkstoffgruppe Material group							Bearbeitungsverfahren Application					
			P	M	K	N	S	H	T	M	D	S	G	P	
			Stahl Steel	Rostfrei Stainless	Grauguss Grey cast iron	NE-Metalle Non-ferrous metals	Hochwarmfest High temperature materials	Harde Werkstoffe Hard materials	Drehen Turning	Fräsen Milling	Bohren Drilling	Gewinde- bearbeitung Threading	Einstechen Grooving	Abstechen Parting	
LCP15T	HC-P15		■							●					
	HC-K15				□					●					
LCP25T	HC-P25		■							●					
	HC-M25			□						●					
LC240F	HC-P40		■							●					
	HC-M40			□						●					
LCM20T	HC-M20			■						●					
	HC-S20							□		●					
BCM25T	HC-M25			■						●					
	HC-P30		□							●					
BCM40T	HC-M40			■						●					
	HC-S40							□		●					
LC435D	HC-M35			■						●					
	HC-P35		□							●					
LCM45T	HC-M40			■						●	●				
	HC-P35		□							●	●				
LC610H	HC-K10				■					●					
	HC-K15				■					●					
LC620H	HC-K15				■					●					
LW610	HW-K10					■				●	●				
LC610T	HC-K10		□	□	□	■				●					
LC415X	HC-S15			□				■		●					
LC415Z	HC-S15			□				■		●					
BCS10T	HC-M10							■		●					
	HC-S10			□						●					
BCS20T	HC-M20							■		●					
	HC-S20			□						●					
LW611	HW-K10				■	□				●					

Anwendungsschwerpunkt
Application peak

Gesamtbereich nach ISO 513
Full range to ISO 513

■ Hauptanwendung
Main application

□ Weitere Anwendungen
Further applications

● Standardsorte
Standard grade

Hauptsorten beschichtet● **LCP15T (HC-P15, HC-K15)**

Verschleißfeste Stahlsorte für den nichtunterbrochenen Schnitt für hohe Schnittgeschwindigkeiten bis 300 m/min. Als Nebenanwendung auch für die Bearbeitung von Guss geeignet.

● **LCP25T (HC-P25, HC-M25)**

(Universelle Drehsorte)
Hauptsorte zum Drehen von Stahlwerkstoffen und leicht zerspanbaren rostbeständigen Stahl bei mittleren Schnittgeschwindigkeiten, auch bei unterbrochenem Schnitt. Diese Mehrbereichssorte zeichnet sich durch hohe Verschleißfestigkeit und ausgezeichnete Zähigkeitseigenschaften in einem breiten Einsatzspektrum aus.

● **LC240F (HC-P40, HC-M40)**

Die Stahldrehsorte Steeltec LC240F gewährleistet durch das Zusammenspiel eines extrem zähen Hartmetalls mit der „Nanolock gelb MT-CVD-Schicht“ höchste Performance im stark unterbrochenen Schnitt.

● **LCM20T (HC-M20, HC-S20)**

Drehsorte für die Bearbeitung von austenitischen Werkstoffen im hohen Schnittgeschwindigkeitsbereich von 170 - 220 m/min.

● **BCM25T (HC-M25, HC-P25)**

Drehsorte für austenitische rostfreie Stähle im mittleren bis hohen Schnittgeschwindigkeitsbereich.

● **BCM40T (HC-M40, HC-S40)**

Sehr zähe Rostfreisorte für niedrige Schnittgeschwindigkeiten geeignet, als Alternative auch auf Stahl und Superlegierungen einsetzbar.

● **LC435D (HC-M35, HC-P35)**

Hauptsorte zu Drehen von austenitischen rostfreien Stählen bei mittleren Schnittgeschwindigkeiten. Erweiterte Anwendung für Superlegierungen.

● **LCM45T (HC-M40, HC-P40)**

Extrem zähes, relativ feinkörniges Hartmetallsubstrat. Ideale Sorte zum Drehen von austenitischen rostfreien Stählen im mittleren Schnittgeschwindigkeitsbereich.

● **LC610H (HC-K10-K15)**

Gussorte im Bereich K10, optimal für die Bearbeitung von Guss im nicht unterbrochenen Schnitt.

● **LC620H (HC-K15)**

Gussdrehsorte im Bereich K15, optimal für die Bearbeitung von GG- und GGG- Materialien. Schnittgeschwindigkeiten bis 400m/min auf GG möglich.

● **LC610T (HC-K10)**

Ideale Sorte für die Bearbeitung von Aluminiumwerkstoffen und NE-Metallen. Durch eine hauchdünne Micropuls® Plasma-CVD TiAlN Schicht ebenfalls hervorragend für die Schlichtzerspannung von rostfreien Stählen und Grauguss geeignet.

● **BCS10T (HC-M10, HC-S10)**

Sorte für das Drehen von Titan. Ausgewähltes temperaturstabiles Hartmetall plus TiBN - Plasma - Beschichtung.

● **LC415X (HC-S15)**

Feinstkornsorte mit dünner PVD-Beschichtung. Hervorragend geeignet für die Klein- und Kleinstteillfertigung wie z.B. der Uhrenindustrie und Medizintechnik. Bevorzugte Materialien wie Inconel, Titan und Rostfreistahl.

● **LC415Z (HC-S15)**

Spezielle Feinstkornsorte für die Bearbeitung von Superlegierungen wie Inconel, Titan, etc.

● **BCS20T (HC-M20, HC-S20)**

Zähere Alternativsorte zur LC415Z für die Bearbeitung von Superlegierungen wie Inconel, Hastelloy, Waspaloy, etc.

Hauptsorten unbeschichtet● **LW610 (K10)**

Drehsorte mit hoher Verschleißfestigkeit für die Bearbeitung von Aluminiumlegierungen und NE-Metallen bei mittleren bis hohen Schnittgeschwindigkeiten, auch unter ungünstigen Bedingungen.

● **LW611 (K05-K15)**

Zum Drehen von Hartguss, Grauguss mit Kugelgraphit und legiertem Grauguss sowie für Aluminium und Aluminiumlegierungen. Drehen von hochvergüteten und gehärteten Stählen, auch für Manganhartstähle.

Main grades, coated

● **LCP15T (HC-P15, HC-K15)**

Wear resistant steel grade for not interrupted cut for high cutting speeds up to 300 m/min. As secondary application also for machining of cast iron.

● **LCP25T (HC-P25, HC-M25)**

(Universal turning grade)

Main grade for machining steel materials and easily machinable stainless steels at medium cutting speeds, including interrupted cutting work. This general purpose grade is characterised by the properties of high durability and excellent toughness across a wide range of applications.

● **LC240F (HC-P40, HC-M40)**

The LC240F Steeltex steel turning grade guarantees maximum performance in heavy interrupted cutting thanks to the combination of an extremely tough carbide with the „Nanolock yellow MT-CVD layer“.

● **LCM20T (HC-M20, HC-S20)**

Turning grade for machining of austenitic materials in the high cutting speed area of 170 – 220 m/min.

● **BCM25T (HC-M25, HC-P25)**

Turning grade for austenitic stainless steels in medium and high cutting speed area.

● **BCM40T (HC-M40, HC-S40)**

Very tough stainless grade for low cutting speeds suitable, also as alternative applicable on steel and super alloys.

● **LC435D (HC-M35, HC-P35)**

Main grade for turning of austenitic stainless steels at medium cutting speeds. Applicable also for super alloys.

● **LCM45T (HC-M40, HC-P40)**

Extreme tough, relative fine grained carbide substrate. Ideal grade for turning of austenitic stainless steel in the medium cutting speed area.

● **LC610H (HC-K10-K15)**

Cast iron grades in K10 range, optimum for machining cast iron in an uninterrupted cut.

● **LC620H (HC-K15)**

Cast iron turning grade for the area K15. Optimal for machining GG- and GGG- materials. Possible cutting speeds for GG up to 400 m/min.

● **LC610T (HC-K10)**

The ideal grade for working aluminium materials and other non-ferrous metals. Thanks to a very thin microplus[®] plasma CVD TiAlN coating it is also excellent for finish machining of stainless steels and grey cast iron.

● **BCS10T (HC-M10, HC-S10)**

Grade for turning of titanium. Selected temperature stable carbide plus TiBN - Plasma coating.

● **LC415X (HC-S15)**

Submicron grade with thin PVD-coating. Excellent appropriate for the production of small and smallest parts, f.e. watch industry and medical engineering. Preferred materials such as Inconel, titanium and stainless steel.

● **LC415Z (HC-S15)**

Special submicron grade for machining super alloys such as Inconel, titanium, etc.

● **BCS20T (HC-M20, HC-S20)**

Tough alternative grade to LC415Z for machining of super alloys such as Inconel, Hastelloy, Waspaloy, etc.

Main grades, uncoated

● **LW610 (K10)**

Turning grade with high wear resistance for machining of aluminium alloys, and non-ferrous metals at medium to higher cutting speeds, even under unfavourable machining conditions.

● **LW611 (K05-K15)**

For turning chilled iron casting, grey cast iron with spheroidal graphite and alloyed grey cast iron as well as for aluminium and aluminium alloys. Turning high grade and hardened steels, also for austenitic manganese steels.

W	Grundform Basic form	
A		85°
B		82°
C		80°
D		55°
E		75°
H		120°
K		55°
L		90°
M		86°
O		135°
P		108°
R		-
S		90°
T		60°
V		35°
W		80°

N	Freiwinkel Clearance angle
A	
B	
C	
D	
E	
F	
G	
N	
P	
O	

Freiwinkel, bei denen besondere Angaben erforderlich sind
Clearance angle requiring special indication

M	Toleranzklasse Tolerance classes																																																				
Zulässige Abweichung für Limits of tolerance																																																					
	<table border="1"> <thead> <tr> <th></th> <th>m</th> <th>s</th> <th>d</th> </tr> </thead> <tbody> <tr><td>A</td><td>±0,005¹⁾</td><td>±0,025</td><td>±0,025</td></tr> <tr><td>C</td><td>±0,013</td><td>±0,025</td><td>±0,025</td></tr> <tr><td>E</td><td>±0,025</td><td>±0,025</td><td>±0,025</td></tr> <tr><td>F</td><td>±0,005¹⁾</td><td>±0,025</td><td>±0,013</td></tr> <tr><td>G</td><td>±0,025</td><td>±0,13</td><td>±0,025</td></tr> <tr><td>H</td><td>±0,013</td><td>±0,025</td><td>±0,013</td></tr> <tr><td>J</td><td>±0,005¹⁾</td><td>±0,025</td><td>±0,05 - ±0,15</td></tr> <tr><td>K</td><td>±0,013¹⁾</td><td>±0,025</td><td>±0,05 - ±0,15</td></tr> <tr><td>L</td><td>±0,025</td><td>±0,025</td><td>±0,05 - ±0,15</td></tr> <tr><td>M</td><td>±0,08 - ±0,20</td><td>±0,13</td><td>±0,05 - ±0,15</td></tr> <tr><td>U</td><td>±0,13 - ±0,38</td><td>±0,13</td><td>±0,08 - ±0,25</td></tr> </tbody> </table>		m	s	d	A	±0,005 ¹⁾	±0,025	±0,025	C	±0,013	±0,025	±0,025	E	±0,025	±0,025	±0,025	F	±0,005 ¹⁾	±0,025	±0,013	G	±0,025	±0,13	±0,025	H	±0,013	±0,025	±0,013	J	±0,005 ¹⁾	±0,025	±0,05 - ±0,15	K	±0,013 ¹⁾	±0,025	±0,05 - ±0,15	L	±0,025	±0,025	±0,05 - ±0,15	M	±0,08 - ±0,20	±0,13	±0,05 - ±0,15	U	±0,13 - ±0,38	±0,13	±0,08 - ±0,25				
	m	s	d																																																		
A	±0,005 ¹⁾	±0,025	±0,025																																																		
C	±0,013	±0,025	±0,025																																																		
E	±0,025	±0,025	±0,025																																																		
F	±0,005 ¹⁾	±0,025	±0,013																																																		
G	±0,025	±0,13	±0,025																																																		
H	±0,013	±0,025	±0,013																																																		
J	±0,005 ¹⁾	±0,025	±0,05 - ±0,15																																																		
K	±0,013 ¹⁾	±0,025	±0,05 - ±0,15																																																		
L	±0,025	±0,025	±0,05 - ±0,15																																																		
M	±0,08 - ±0,20	±0,13	±0,05 - ±0,15																																																		
U	±0,13 - ±0,38	±0,13	±0,08 - ±0,25																																																		
	<table border="1"> <thead> <tr> <th></th> <th>d</th> <th>m</th> <th>d</th> </tr> </thead> <tbody> <tr><td>M</td><td>6,35</td><td>±0,08</td><td>±0,05</td></tr> <tr><td></td><td>9,52</td><td>±0,08</td><td>±0,05</td></tr> <tr><td></td><td>12,7</td><td>±0,13</td><td>±0,08</td></tr> <tr><td></td><td>15,88</td><td>±0,15</td><td>±0,10</td></tr> <tr><td></td><td>19,05</td><td>±0,15</td><td>±0,10</td></tr> <tr><td></td><td>25,4</td><td>±0,18</td><td>±0,13</td></tr> <tr><td>U</td><td>6,35</td><td>±0,13</td><td>±0,08</td></tr> <tr><td></td><td>9,52</td><td>±0,13</td><td>±0,08</td></tr> <tr><td></td><td>12,7</td><td>±0,20</td><td>±0,13</td></tr> <tr><td></td><td>15,88</td><td>±0,27</td><td>±0,18</td></tr> <tr><td></td><td>19,05</td><td>±0,27</td><td>±0,18</td></tr> <tr><td></td><td>25,4</td><td>±0,38</td><td>±0,25</td></tr> </tbody> </table>		d	m	d	M	6,35	±0,08	±0,05		9,52	±0,08	±0,05		12,7	±0,13	±0,08		15,88	±0,15	±0,10		19,05	±0,15	±0,10		25,4	±0,18	±0,13	U	6,35	±0,13	±0,08		9,52	±0,13	±0,08		12,7	±0,20	±0,13		15,88	±0,27	±0,18		19,05	±0,27	±0,18		25,4	±0,38	±0,25
	d	m	d																																																		
M	6,35	±0,08	±0,05																																																		
	9,52	±0,08	±0,05																																																		
	12,7	±0,13	±0,08																																																		
	15,88	±0,15	±0,10																																																		
	19,05	±0,15	±0,10																																																		
	25,4	±0,18	±0,13																																																		
U	6,35	±0,13	±0,08																																																		
	9,52	±0,13	±0,08																																																		
	12,7	±0,20	±0,13																																																		
	15,88	±0,27	±0,18																																																		
	19,05	±0,27	±0,18																																																		
	25,4	±0,38	±0,25																																																		
<p>Wendeschneidplatte mit ungerader Seitenanzahl Indexable insert with unequal number of sides</p>																																																					
<p>Wendeschneidplatte mit gerader Seitenanzahl Indexable insert with equal number of sides</p>																																																					
<p>¹⁾ Gelten in der Regel für Wendeschneidplatten mit geschliffenen Planschneiden. *) Der Berechnung der „m“-Maße liegt der genaue Zoll-Radius zugrunde.</p> <p>¹⁾ Generally used for indexable inserts with ground face cutting edges. *) The calculation for the „m” measurement is based on the precise radius in inches.</p>																																																					

G	Plattentyp Type of insert
A	<p>ohne Spanformrinne, mit Befestigungsloch without chip breaker, with cylindrical fixation hole</p>
F	<p>mit Spanformrinne auf beiden Spanflächen, ohne Befestigungsloch Chip breaker at both sides, without fixation hole</p>
G	<p>mit Spanformrinne auf beiden Spanflächen, mit Befestigungsloch Chip breaker at both sides, with cylindrical fixation hole</p>
M	<p>mit Spanformrinne auf einer Spanfläche, mit Befestigungsloch Chip breaker at one side, with cylindrical fixation hole</p>
N	<p>ohne Spanformrinne, ohne Befestigungsloch without chip breaker, without fixation hole</p>
Q	<p>ohne Spanformrinne, mit Kegelloch beidseitig without chip breaker, with fixation hole conical from both sides</p>
R	<p>mit Spanformrinne auf einer Spanfläche, ohne Befestigungsloch Chip breaker at one side, without fixation hole</p>
T	<p>mit Spanformrinne auf einer Spanfläche, Kegelloch einseitig Chip breaker at one side, with conical fixation hole</p>
U	<p>mit Spanformrinne auf beiden Spanflächen, Kegelloch beidseitig Chip breaker at both sides, with fixation hole conical from both sides</p>
W	<p>ohne Spanformrinne, Kegelloch einseitig without chip breaker, with conical fixation hole</p>
X	<p>mit Besonderheiten nach Zeichnung with special features to drawing</p>











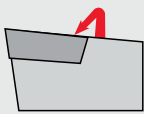

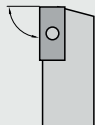

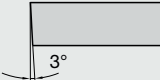
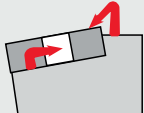

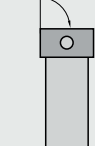

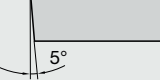
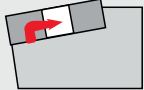

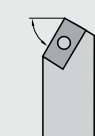

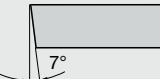
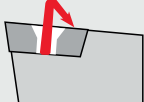

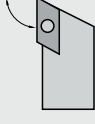



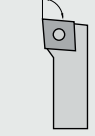
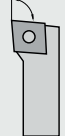
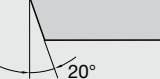

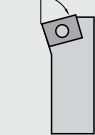

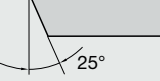

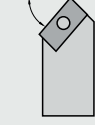
06 Schneidkantenlänge Length of cutting edge	
A	
B	
C	
E	
D	
H	
K	
L	
M	
O	
P	
R	
S	
T	
V	
W	
Beispiele: Examples:	
06	l = 6,350 mm
09	l = 9,525 mm
11	l = 11,000 mm
12	l = 12,700 mm
15	l = 15,880 mm
16	l = 16,500 mm
19	l = 19,050 mm
22	l = 22,000 mm
25	l = 25,400 mm
27	l = 27,500 mm
33	l = 33,000 mm

04 Dicke Thickness	
Beispiele: Examples:	
01	s = 1,59 mm
T1	s = 1,98 mm
02	s = 2,38 mm
03	s = 3,18 mm
T3	s = 3,97 mm
04	s = 4,76 mm
05	s = 5,56 mm
06	s = 6,35 mm
07	s = 7,94 mm
09	s = 9,52 mm
12	s = 12,70 mm

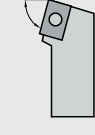
04 Schneidenecke Corner radius	
Beispiele: Examples:	
00	r = max 0,2 mm
04	r = 0,4 mm ±0,1
08	r = 0,8 mm ±0,1
12	r = 1,2 mm ±0,1
16	r = 1,6 mm ±0,1
20	r = 2,0 mm ±0,1
24	r = 2,4 mm ±0,1
25	r = 2,5 mm ±0,1

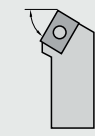
Schneidenausführung Edge condition	
F	 scharfe Schneide sharp cutting edges
E	 Schneiden gerundet Rounded cutting edges
S	 Schneiden gefast und gerundet Chamfered and rounded cutting edges
T	 Schneiden gefast Chamfered cutting edges
K	 Schneiden doppelt gefast Double-chamfered cutting edges
P	 Schneiden doppelt gefast und verrundet Double-chamfered and rounded cutting edges

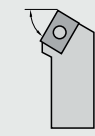
Schnitttrichtung Cutting direction	
L	 Wendeschneidplatte kann nur linksschneidend verwendet werden The indexable insert can only be used for cuts to the left
N	 Wendeschneidplatte kann rechts- und linksschneidend verwendet werden The indexable insert can be used for cuts either to the left or to the right
R	 Wendeschneidplatte kann nur rechtsschneidend verwendet werden The indexable insert can only be used for cuts to the right

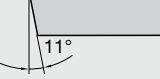
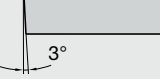
P Befestigungsart Type of fixation	C Wendeplattenform Indexable insert shape	L Klemmhalterform Tool holder shape	N Wendeplattenfreiwinkel Insert clearance angle
C  Von oben geklemmt Fixation from above	A  85° B  82°	A  90° B  75°	A  3°
M  Von oben und über Bohrung geklemmt Fixation from above and through a hole	C  80° D  55°	C  90° D  45°	B  5°
P  Über Bohrung geklemmt Fixation through a hole	E  75° H  120°	E  60° F  90°	C  7°
S  Durch Bohrung geschraubt Fixation by screw through a conical hole	K  55° L  90°	G  90° J  93°	D  15°
	M  86° O  135°	H  107,5° L  95°	E  20°
	P  108° R  -	K  75° N  63°	F  25°
	S  90° T  60°	M  50° S  45°	G  30°
	V  35° W  80°	R  75° U  93°	N  0°
	T  60° W  60°	V  72,5° Y  85°	P  11°
			O  3°
			Freiwinkel, bei denen besondere Angaben erforderlich sind Clearance angle requiring special indication

R
Schnittrichtung
Cutting direction

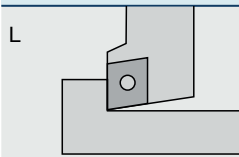

Klemmhalter kann nur linksschneidend verwendet werden
The tool holder can only be used for cuts to the left

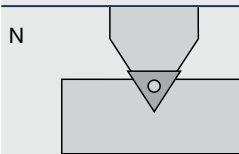

Klemmhalter kann rechts- und linksschneidend verwendet werden
The tool holder can be used for cuts either to the left or to the right

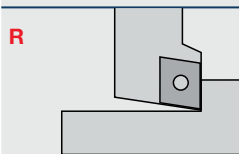

Klemmhalter kann nur rechtsschneidend verwendet werden
The tool holder can only be used for cuts to the right

25
Schneidenhöhe
Cutting height



Bei Klemmwerkzeugen entspricht die Schneidhöhe (h_1) im allgemeinen der Schafthöhe (h_2). Ausgenommen sind Kurzklemmhalter und Klemmwerkzeuge zum Innendreifen.
For clamped tools, the cutting height (h_1) generally corresponds to the shaft height (h_2). The exceptions to this include cartridge toolholders and clamped tools for internal turning.

25
Schaftbreite
Shank width

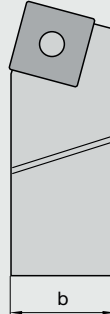

M
Werkzeuglänge
Tool length

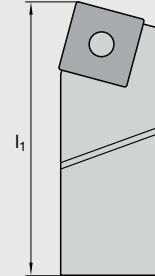

Kennbuchstaben für die Längen l_1
Code letters for the length l_1

A	32 mm
B	40 mm
C	50 mm
D	60 mm
E	70 mm
F	80 mm
G	90 mm
H	100 mm
J	110 mm
K	125 mm
L	140 mm
M	150 mm
N	160 mm
P	170 mm
Q	180 mm
R	200 mm
S	250 mm
T	300 mm
U	350 mm
V	400 mm
W	450 mm
X	Sonderlänge Special length
Y	500 mm

12
Schneidkantenlänge
Cutting edge length

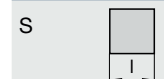
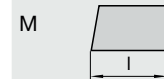

Beispiele:
Examples:

06	$l = 6,350 \text{ mm}$
09	$l = 9,525 \text{ mm}$
11	$l = 11,000 \text{ mm}$
12	$l = 12,700 \text{ mm}$
15	$l = 15,880 \text{ mm}$
16	$l = 16,500 \text{ mm}$
19	$l = 19,050 \text{ mm}$
22	$l = 22,000 \text{ mm}$
25	$l = 25,400 \text{ mm}$
27	$l = 27,500 \text{ mm}$
33	$l = 33,000 \text{ mm}$

S Werkstoff des Körpers Material used for main body		
Kennbuchstabe Identification letter	Werkstoff des Körpers Material used for main body	Konstruktionsmerkmale Features of design
S	Stahlschaft Solid steel	keine none
A		mit innerer Kühlmittelzuführung with internal coolant supply
B		mit Vibrationsdämpfung with vibration damping
D		mit Vibrationsdämpfung und innerer Kühlmittelzuführung with vibration damping and internal coolant supply
C	Hartmetallschaft mit Stahlkopf Hard metal with steel head	keine none
E		mit innerer Kühlmittelzuführung with internal coolant supply
F		mit Vibrationsdämpfung with vibration damping
G		mit Vibrationsdämpfung und innerer Kühlmittelzuführung with vibration damping and internal coolant supply
H	Schwermetall Heavy metal	keine none
J		mit innerer Kühlmittelzuführung with internal coolant supply

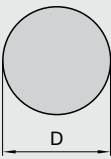
32 Schaftdurchmesser Shank diameter

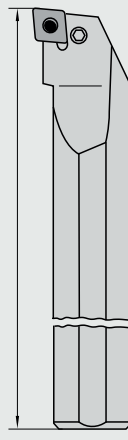
08
10
12
16
20
25
32
40
50

T Werkzeuflänge Tool length

Kennbuchstaben für die Längen Code letters for the length
A 32 mm
B 40 mm
C 50 mm
D 60 mm
E 70 mm
F 80 mm
G 90 mm
H 100 mm
J 110 mm
K 125 mm
L 140 mm
M 150 mm
N 160 mm
P 170 mm
Q 180 mm
R 200 mm
S 250 mm
T 300 mm
U 350 mm
V 400 mm
W 450 mm
X Sonderlänge Special length
Y 500 mm

P Befestigungsart Type of fixation
C  Von oben geklemmt Fixation from above
M  Von oben und über Bohrung geklemmt Fixation from above and through a hole
P  Über Bohrung geklemmt Fixation through a hole
S  Durch Bohrung geschraubt Fixation by screw through a conical hole

C		Wendeplattenform Indexable insert shape	
A		85°	
B		82°	
C		80°	
D		55°	
E		75°	
H		120°	
K		55°	
L		90°	
M		86°	
O		135°	
P		108°	
R		-	
S		90°	
T		60°	
V		35°	
W		80°	

L		Klemhalterform Tool holder shape	
F		90°	
K		75°	
L		95°	
S		45°	
U		93°	
Q		107°	

N		Wendeplattenfreiwinkel Insert clearance angle	
A		3°	
B		5°	
C		7°	
D		15°	
E		20°	
F		25°	
G		30°	
N		0°	
P		11°	
O		α°	

Freiwinkel, bei denen besondere Angaben erforderlich sind.
Clearance angle requiring special indication.

R		Schnittrichtung Cutting direction	
L			
R			







Halter kann nur linksschneidend verwendet werden
Boring bar suitable for operation to the left only

Halter kann nur rechtsschneidend verwendet werden
Boring bar suitable for operation to the right only

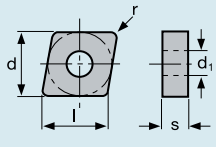
12		Schneidkantenlänge Cutting edge length	
A			
B			
C			
E			
D			
H			
K			
L			
M			
O			
P			
R			
S			
T			
V			
W			

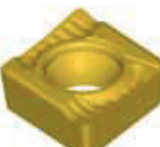
Beispiele:
Examples:

- 06 l = 6,350 mm
- 09 l = 9,525 mm
- 11 l = 11,000 mm
- 12 l = 12,700 mm**
- 15 l = 15,880 mm
- 16 l = 16,500 mm
- 19 l = 19,050 mm
- 22 l = 22,000 mm
- 25 l = 25,400 mm
- 27 l = 27,500 mm
- 33 l = 33,000 mm

	Bestellbezeichnung Ordering Code	I	IC	Sorte Grade													
				HC				HW	HC	HW	HC						
				LCP15T	LCP25T	LC240F	LCM20T	LC435D	BCM25T	BCM40T	LC610H	LC620H	LW611	LC610T	LW610	LC415X	LC415Z
	CCGT...BAL																
	CCGT 060202-BAL	6,40	6,35									●	●				
	CCGT 060204-BAL	6,40	6,35									●	●				
	CCGT 09T302-BAL	9,70	9,52									●	●				
	CCGT 09T304-BAL	9,70	9,52									●	●				
	CCGT 09T308-BAL	9,70	9,52									●	●				
	CCGT 120404-BAL	12,90	12,70									●	●				
	CCGT 120408-BAL	12,90	12,70								●	●					
	CCGT E.-BC																
	CCGT 060204 EL-BC	6,40	6,35	●	●		●										
	CCGT 060204 ER-BC	6,40	6,35	●	●		●										
	CCGT 060208 EL-BC	6,40	6,35	●	●		●										
	CCGT 060208 ER-BC	6,40	6,35	●	●		●										
	CCGT 09T304 EL-BC	9,70	9,52	●	●		●										
	CCGT 09T304 ER-BC	9,70	9,52	●	●		●										
	CCGT 09T308 EL-BC	9,70	9,52	●	●		●										
	CCGT 09T308 ER-BC	9,70	9,52	●	●		●										
	CCGT 120408 EL-BC	12,90	12,70	●	●		●										
CCGT 120408 ER-BC	12,90	12,70	●	●		●											
CCGT 120412 EL-BC	12,90	12,70	●	●		●											
CCGT 120412 ER-BC	12,90	12,70	●	●		●											
	CCMT...BSM																
	CCMT 09T304-BSM	9,70	9,52								●						
	CCMT 09T308-BSM	9,70	9,52								●						
	CCMT 120408-BSM	12,90	12,70								●						
	CCMT...BSMR																
	CCMT 250924-BSMR	25,80	25,40	●	●						●						
	CCMT...BSMS																
	CCMT 09T304-BSMS	9,70	9,52														
	CCMT 09T308-BSMS	9,70	9,52														
	CCMT 120404-BSMS	12,90	12,70														
	CCMT 120408-BSMS	12,90	12,70														

Bestellbeispiel Order example: 10 Stück 10 pieces CCGT 060202-BAL LC610T

● Verfügbar ab Lager Available from stock

Werkzeuge siehe Seiten 75-77 / 94

For tool holders see pages 75-77 / 94

Schnittdatenrichtwerte siehe ab Seite 110

For cutting data standard values see from page 110

	Bestellbezeichnung Ordering Code	I	IC	Sorte Grade															
				HC				HW	HC	HW	HC								
				LCP15T	LCP25T	LC240F	LCM20T	LC435D	BCM25T	BCM40T	LC610H	LC620H	LW611	LC610T	LW610	LC415X	LC415Z	BCS10T	BCS20T
CCMT....-F 	CCMT 060202-FP	6,40	6,35	●	●														
	CCMT 060204-FP	6,40	6,35	●	●														
	CCMT 060208-FP	6,40	6,35	●	●														
	CCMT 09T304-FP	9,70	9,52	●	●														
	CCMT 09T308-FP	9,70	9,52	●	●														
	CCMT 120404-FP	12,90	12,70	●	●														
	CCMT 09T304-FM	9,70	9,52					●	●										
CCMT....-MM 	CCMT 060202-MM	6,40	6,35					●	●	●									
	CCMT 060204-MM	6,40	6,35					●	●	●									
	CCMT 09T304-MM	9,70	9,52					●		●									
	CCMT 09T308-MM	9,70	9,52					●		●									
	CCMT 120404-MM	12,90	12,70							●									
	CCMT 120408-MM	12,90	12,70							●									
CCMT....-MP 	CCMT 060202-MP	6,40	6,35	●	●														
	CCMT 060204-MP	6,40	6,35	●	●														
	CCMT 060208-MP	6,40	6,35	●	●														
	CCMT 09T304-MP	9,70	9,52	●	●														
	CCMT 09T308-MP	9,70	9,52	●	●														
	CCMT 120404-MP	12,90	12,70	●	●														
	CCMT 120408-MP	12,90	12,70	●	●														
CCMT...MT 	CCMT 09T304-MT	9,70	9,52												●	●			
CCMW.... 	CCMW 09T304	9,70	9,52								●								

Bestellbeispiel Order example: 10 Stück 10 pieces CCMT 060202-FP LCP25T

● Verfügbar ab Lager Available from stock

Werkzeuge siehe Seiten 75-77 / 94

For tool holders see pages 75-77 / 94

Schnittdatenrichtwerte siehe ab Seite 110

For cutting data standard values see from page 110

	Bestellbezeichnung Ordering Code	I	IC	Sorte Grade													
				HC				HW	HC	HW	HC						
				LCP15T	LCP25T	LC240F	LCM20T	LC435D	BCM25T	BCM40T	LC610H	LC620H	LW611	LC610T	LW610	LC415X	LC415Z
CNGG....-BCU 	CNGG 120408-BCU	12,90	12,70	●	●												
CNGG...-FMS 	CNGG 120404-FMS	12,90	12,70												●	●	
	CNGG 120408-FMS	12,90	12,70												●	●	
	CNGG 120412-FMS	12,90	12,70												●	●	
CNGG....-MS 	CNGG 120404-MS	12,90	12,70												●		
	CNGG 120408-MS	12,90	12,70												●		
	CNGG 120412-MS	12,90	12,70												●		
CNGG...-MRS 	CNGG 120408-MRS	12,90	12,70												●	●	
	CNGG 120412-MRS	12,90	12,70												●	●	
CNMA 	CNMA 120408	12,90	12,70						●	●							
	CNMA 120412	12,90	12,70						●	●							
	CNMA 190616	19,30	19,05							●							
	CNMA 250924	25,80	25,40							●							

Bestellbeispiel Order example: 10 Stück 10 pieces CNGG 120408-BCU LCP15T

● Verfügbar ab Lager Available from stock

Werkzeuge siehe Seiten 64 / 68 / 90

For tool holders see pages 64 / 68 / 90

Schnittdatenrichtwerte siehe ab Seite 110

For cutting data standard values see from page 110

	Bestellbezeichnung Ordering Code	I	IC	Sorte Grade													
				HC				HW	HC	HW	HC						
				LCP15T	LCP25T	LC240F	LCM20T	LC435D	BCM25T	BCM40T	LC610H	LC620H	LW611	LC610T	LW610	LC415X	LC415Z
	CNMG....-BFMS																
	CNMG 090304-BFMS	9,70	9,52		●	●	●										
	CNMG 120404-BFMS	12,90	12,70		●	●	●										
	CNMG 120408-BFMS	12,90	12,70		●	●	●										
	CNMG 120412-BFMS	12,90	12,70		●	●	●										
	CNMG....-BM																
	CNMG 120408-BM	12,90	12,70						●	●							
	CNMG 120412-BM	12,90	12,70						●	●							
	CNMG....-BMR																
	CNMG 120408-BMR	12,90	12,70						●	●							
	CNMG 120412-BMR	12,90	12,70						●	●							
	CNMG 120416-BMR	12,90	12,70						●	●							
	CNMG 160612-BMR	16,10	15,87						●	●							
	CNMG 160616-BMR	16,10	15,87						●	●							
	CNMG....-BMRS																
	CNMG 120408-BMRS	12,90	12,70					●	●								
	CNMG 120412-BMRS	12,90	12,70					●	●								
	CNMG 160612-BMRS	16,10	15,87					●	●								
	CNMG 160616-BMRS	19,30	19,05						●	●							
	CNMG 190612-BMRS	19,30	19,05					●	●								
	CNMG....-BMS																
	CNMG 120408-BMS	12,90	12,70					●									
	CNMG 120412-BMS	12,90	12,70					●									
	CNMG 160612-BMS	16,10	15,87					●									

Bestellbeispiel Order example: 10 Stück 10 pieces CNMG 090304-BFMS LC435D



● Verfügbar ab Lager Available from stock

Werkzeuge siehe Seiten 64 / 68 / 90

For tool holders see pages 64 / 68 / 90

Schnittdatenrichtwerte siehe ab Seite 110

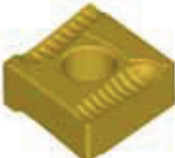
For cutting data standard values see from page 110

	Bestellbezeichnung Ordering Code	l	IC	Sorte Grade													
				HC				HW	HC	HW	HC						
				LCP15T	LCP25T	LC240F	LCM20T	LC435D	BCM25T	BCM40T	LC610H	LC620H	LW611	LC610T	LW610	LC415X	LC415Z
	CNMG 120404 EL-BC	12,90	12,70	●	●		●										
	CNMG 120404 ER-BC	12,90	12,70	●	●		●										
	CNMG 120408 EL-BC	12,90	12,70	●	●		●										
	CNMG 120408 ER-BC	12,90	12,70	●	●		●										
	CNMG 120404-FMP	12,90	12,70	●	●				●	●							
	CNMG 120408-FMP	12,90	12,70	●	●	●											
	CNMG 120404-FP	12,90	12,70	●	●												
	CNMG 120408-FP	12,90	12,70	●	●												
	CNMG 120408-HPT	12,90	12,70	●	●												
	CNMG 120412-HPT	12,90	12,70	●	●												
	CNMG 120408-MM	12,90	12,70				●	●	●								
	CNMG 120412-MM	12,90	12,70				●	●	●								
	CNMG 160612-MM	16,10	15,87				●	●	●								
	CNMG 160616-MM	16,10	15,87				●	●	●								
	CNMG 190612-MM	19,30	19,05				●		●								
	CNMG 190616-MM	19,30	19,05				●		●								

Bestellbeispiel Order example: 10 Stück 10 pieces CNMG 120404 EL-BC LCP25T

● Verfügbar ab Lager Available from stock

Werkzeuge siehe Seiten 64 / 68 / 90

For tool holders see pages 64 / 68 / 90

Schnittdatenrichtwerte siehe ab Seite 110

For cutting data standard values see from page 110

	Bestellbezeichnung Ordering Code	I	IC	Sorte Grade													
				HC				HW	HC	HW	HC						
				LCP15T	LCP25T	LC240F	LCM20T	LC435D	BCM25T	BCM40T	LC610H	LC620H	LW611	LC610T	LW610	LC415X	LC415Z
CNMG....-MP 	CNMG 090308-MP	9,70	9,52	●	●	●											
	CNMG 120408-MP	12,90	12,70	●	●	●											
	CNMG 120412-MP	12,90	12,70	●	●	●											
	CNMG 120416-MP	12,90	12,70	●	●	●											
	CNMG 160608-MP	16,10	15,87	●	●	●											
	CNMG 160612-MP	16,10	15,87	●	●	●											
	CNMG 160616-MP	16,10	15,87	●	●	●											
	CNMG 190612-MP	19,30	19,05	●	●	●											
	CNMG 190616-MP	19,30	19,05	●	●	●											
CNMG....-MRP 	CNMG 120408-MRP	12,90	12,70	●	●	●											
	CNMG 120412-MRP	12,90	12,70	●	●	●											
	CNMG 120416-MRP	12,90	12,70	●	●	●											
	CNMG 160608-MRP	16,10	15,87	●	●	●											
	CNMG 160612-MRP	16,10	15,87	●	●	●											
	CNMG 160616-MRP	16,10	15,87	●	●	●											
	CNMG 190612-MRP	19,30	19,05	●	●	●											
	CNMG 190616-MRP	19,30	19,05	●	●	●											
	CNMG 190624-MRP	19,30	19,05	●	●	●											
CNMG....-MS 	CNMG 120404-MS	12,90	12,70												●		
	CNMG 120408-MS	12,90	12,70												●		
	CNMG 120412-MS	12,90	12,70												●		
CNMG...MT 	CNMG 120408-MT	12,90	12,70												●	●	
CNMM....-RP 	CNMM 120408-RP	12,90	12,70	●	●	●											
	CNMM 120412-RP	12,90	12,70	●	●	●											
	CNMM 160612-RP	16,10	15,87	●	●	●											
	CNMM 160616-RP	16,10	15,87	●	●	●											
	CNMM 190612-RP	19,30	19,05	●	●	●											
	CNMM 190616-RP	19,30	19,05	●	●	●											
	CNMM 190624-RP	19,30	19,05	●	●	●											

Bestellbeispiel Order example: 10 Stück 10 pieces CNMG 090308-MP LCP15T



● Verfügbar ab Lager Available from stock



Werkzeuge siehe Seiten 64 / 68 / 90

For tool holders see pages 64 / 68 / 90

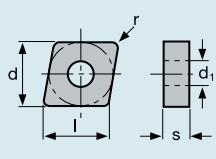
Schnittdatenrichtwerte siehe ab Seite 110

For cutting data standard values see from page 110

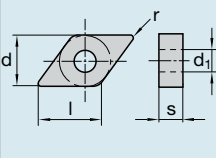

	Bestellbezeichnung Ordering Code		Sorte Grade																
			I IC		HC				HW	HC	HW	HC							
					LCP15T	LCP25T	LC240F	LCM20T	LC435D	BCM25T	BCM40T	LC610H	LC620H	LW611	LC610T	LW610	LC415X	LC415Z	BCS10T
CNMM....-BR 	CNMM 190616-BR	19,30 19,05	●	●	●														
	CNMM 190624-BR	19,30 19,05																	
CNMM....-BRP 	CNMM 250724-BRP	25,80 25,40	●	●	●														
	CNMM 250924-BRP	25,80 25,40	●	●	●														

	Bestellbezeichnung Ordering Code		Sorte Grade																
			I IC		HC				HW	HC	HW	HC							
					LCP15T	LCP25T	LC240F	LCM20T	LC435D	BCM25T	BCM40T	LC610H	LC620H	LW611	LC610T	LW610	LC415X	LC415Z	BCS10T
DCGT... 	DCGT 0702008	7,70 6,35																●	
	DCGT 0702015	7,70 6,35																●	
	DCGT 11T3015	11,60 9,52																●	
	DCGT 11T3035	11,60 9,52																●	
DCGT....-BAL 	DCGT 070202-BAL	7,70 6,35											●	●					
	DCGT 070204-BAL	7,70 6,35											●	●					
	DCGT 11T302-BAL	11,60 9,52											●	●					
	DCGT 11T304-BAL	11,60 9,52											●	●					
	DCGT 11T308-BAL	11,60 9,52											●	●					

Bestellbeispiel Order example: 10 Stück 10 pieces CNMM 190616-BR LCP25T

● Verfügbar ab Lager Available from stock

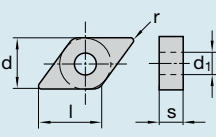
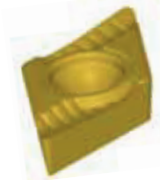
Werkzeuge siehe Seiten 64 / 68 / 78-79 / 90 / 95
For tool holders see pages 64 / 68 / 78-79 / 90 / 95
Schnittdatenrichtwerte siehe ab Seite 110
For cutting data standard values see from page 110

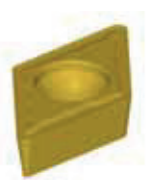
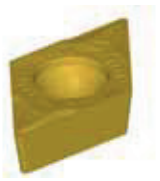
	Bestellbezeichnung Ordering Code		Sorte Grade																
			l	IC	HC				HW	HC	HW	HC							
					LCP15T	LCP25T	LC240F	LCM20T	LC435D	BCM25T	BCM40T	LC610H	LC620H	LW611	LC610T	LW610	LC415X	LC415Z	BCS10T
	DCGT 070204 EL-BC	7,70 6,35	●	●		●													
	DCGT 070204 ER-BC	7,70 6,35	●	●		●													
	DCGT 11T304 EL-BC	11,60 9,52	●	●		●													
	DCGT 11T304 ER-BC	11,60 9,52	●	●		●													
	DCGT 11T308 EL-BC	11,60 9,52	●	●	●	●													
	DCGT 11T308 ER-BC	11,60 9,52	●	●	●	●													
	DCGT 070208 FL-BC	7,70 6,35															●		
	DCGT 070208 FR-BC	7,70 6,35															●		
	DCGT 0702015 FL-BC	7,70 6,35															●		
	DCGT 0702015 FR-BC	7,70 6,35															●		
	DCGT 11T3015 FL-BC	11,60 9,52															●		
	DCGT 11T3015 FR-BC	11,60 9,52															●		
	DCGT 11T3035 FL-BC	11,60 9,52															●		
	DCGT 11T3035 FR-BC	11,60 9,52															●		
	DCMT 070204-BSM	7,70 6,35									●	●							
	DCMT 070208-BSM	7,70 6,35									●	●							
	DCMT 11T304-BSM	11,60 9,52									●	●							
	DCMT 11T308-BSM	11,60 9,52									●	●							
	DCMT 11T304-BSMS	11,60 9,52															●		
	DCMT 11T308-BSMS	11,60 9,52																●	
	DCMT 070202-FP	7,70 6,35	●	●															
	DCMT 070204-FP	7,70 6,35	●	●															
	DCMT 11T302-FP	11,60 9,52		●															
	DCMT 11T304-FP	11,60 9,52	●	●															
	DCMT 070202-FM	7,70 6,35				●	●												
	DCMT 11T302-FM	11,60 9,52					●												

Bestellbeispiel Order example: 10 Stück 10 pieces DCGT 070204 EL-BC LCP25T







● Verfügbar ab Lager Available from stock

Werkzeuge siehe Seiten 78-79 / 95

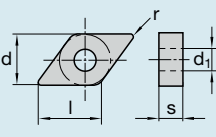
For tool holders see pages 78-79 / 95

Schnittdatenrichtwerte siehe ab Seite 110

For cutting data standard values see from page 110

	Bestellbezeichnung Ordering Code	Sorte Grade																		
		l	IC	HC				HW	HC	HW	HC									
				LCP15T	LCP25T	LC240F	LCM20T	LC435D	BCM25T	BCM40T	LC610H	LC620H	LW611	LC610T	LW610	LC415X	LC415Z	BCS10T	BCS20T	
	DCMT 070204-MM	7,70	6,35																	
	DCMT 11T304-MM	11,60	9,52																	
	DCMT 11T308-MM	11,60	9,52																	
	DCMT 070204-MP	7,70	6,35	●	●															
	DCMT 11T304-MP	11,60	9,52	●	●															
	DCMT 11T308-MP	11,60	9,52	●	●															
	DCMT 11T304-MT	11,60	9,52														●	●		
	DCMW 11T304	11,60	9,52															●		
	DCMW 11T308	11,60	9,52															●		
	DNGG 150404-FMS	15,50	12,70															●	●	
	DNGG 150408-FMS	15,50	12,70																●	●
	DNGG 150412-FMS	15,50	12,70																●	●
	DNGG 150604-FMS	15,50	12,70																●	●
	DNGG 150608-FMS	15,50	12,70																●	●
	DNGG 150612-FMS	15,50	12,70																●	●

Bestellbeispiel Order example: 10 Stück 10 pieces DCMT 070204-MM LC435D

● Verfügbar ab Lager Available from stock

Werkzeuge siehe Seiten 64 / 69 / 78-79 / 91 / 95

For tool holders see pages 64 / 69 / 78-79 / 91 / 95

Schnittdatenrichtwerte siehe ab Seite 110

For cutting data standard values see from page 110

	Bestellbezeichnung Ordering Code	l	IC	Sorte Grade												
				HC				HW	HC	HW	HC					
				LCP15T	LCP25T	LC240F	LCM20T	LC435D	BCM25T	BCM40T	LC610H	LC620H	LW611	LC610T	LW610	LC415X
DNMA... 	DNMA 150608	15,50	12,70							●						
	DNMA 150612	15,50	12,70							●						
DNMG...-BFMS 	DNMG 110404-BFMS	11,60	9,52			●	●	●								
	DNMG 110408-BFMS	11,60	9,52					●	●							
	DNMG 150604-BFMS	15,50	12,70			●	●	●								
	DNMG 150608-BFMS	15,50	12,70			●	●	●								
DNMG....-HPT 	DNMG 150612-HPT	15,50	12,70	●	●											
DNMG....-BMR 	DNMG 150408-BMR	15,50	12,70						●	●						
	DNMG 150412-BMR	15,50	12,70						●	●						
	DNMG 150608-BMR	15,50	12,70						●	●						
	DNMG 150612-BMR	15,50	12,70						●	●						
DNMG....-BMRS 	DNMG 150608-BMRS	15,50	12,70				●	●								
	DNMG 150612-BMRS	15,50	12,70				●	●								

Bestellbeispiel Order example: 10 Stück 10 pieces DNMA 150608 LC620H







● Verfügbar ab Lager Available from stock

Werkzeuge siehe Seiten 64 / 69 / 91

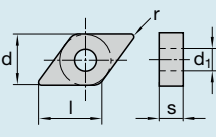
For tool holders see pages 64 / 69 / 91

Schnittdatenrichtwerte siehe ab Seite 110

For cutting data standard values see from page 110

	Bestellbezeichnung Ordering Code	I IC		Sorte Grade															
				HC				HW	HC	HW	HC								
				LCP15T	LCP25T	LC240F	LCM20T	LC435D	BCM25T	BCM40T	LC610H	LC620H	LW611	LC610T	LW610	LC415X	LC415Z	BCS10T	BCS20T
	DNMG....-BMS																		
	DNMG 110408-BMS	11,60	9,52						●										
	DNMG 150408-BMS	15,50	12,70						●										
	DNMG 150608-BMS	15,50	12,70						●										
	DNMG 150612-BMS	15,50	12,70						●										
	DNMG...E.-BC																		
	DNMG 110404 EL-BC	11,60	9,52	●	●	●													
	DNMG 110404 ER-BC	11,60	9,52	●	●	●													
	DNMG 110408 EL-BC	11,60	9,52	●	●	●													
	DNMG 110408 ER-BC	11,60	9,52	●	●	●													
	DNMG 150404 EL-BC	15,50	12,70		●														
	DNMG 150404 ER-BC	15,50	12,70		●														
	DNMG 150408 EL-BC	15,50	12,70		●														
	DNMG 150408 ER-BC	15,50	12,70		●														
	DNMG 150604 EL-BC	15,50	12,70	●	●	●													
	DNMG 150604 ER-BC	15,50	12,70	●	●	●													
DNMG 150608 EL-BC	15,50	12,70	●	●	●														
DNMG 150608 ER-BC	15,50	12,70	●	●	●														
	DNMG...FMP																		
	DNMG 110404-FMP	11,60	9,52	●	●	●				●	●								
	DNMG 110408-FMP	11,60	9,52	●	●					●	●								
	DNMG 150408-FMP	15,50	12,70		●														
	DNMG 150604-FMP	15,50	12,70	●	●	●													
DNMG 150608-FMP	15,50	12,70	●	●	●														
	DNMG....-FP																		
	DNMG 110404-FP	11,60	9,52	●	●														
	DNMG 110408-FP	11,60	9,52	●	●														
	DNMG 150404-FP	15,50	12,70	●	●														
	DNMG 150408-FP	15,50	12,70	●	●														
	DNMG 150604-FP	15,50	12,70	●	●														
DNMG 150608-FP	15,50	12,70	●	●															
	DNMG....-MP																		
	DNMG 110408-MP	11,60	9,52	●	●	●													
	DNMG 150408-MP	15,50	12,70	●	●	●													
	DNMG 150412-MP	15,50	12,70	●	●	●													
	DNMG 150608-MP	15,50	12,70	●	●	●													
	DNMG 150612-MP	15,50	12,70	●	●	●													
DNMG 150616-MP	15,50	12,70	●	●	●														

Bestellbeispiel Order example: 10 Stück 10 pieces DNMG 110408-BMS LC435D

● Verfügbar ab Lager Available from stock

Werkzeuge siehe Seiten 64 / 69 / 91

For tool holders see pages 64 / 69 / 91

Schnittdatenrichtwerte siehe ab Seite 110

For cutting data standard values see from page 110

	Bestellbezeichnung Ordering Code	l	IC	Sorte Grade													
				HC				HW	HC	HW	HC						
				LCP15T	LCP25T	LC240F	LCM20T	LC435D	BCM25T	BCM40T	LC610H	LC620H	LW611	LC610T	LW610	LC415X	LC415Z
	DNMG....-MRP	DNMG 150408-MRP	15,50	12,70	●	●	●										
		DNMG 150412-MRP	15,50	12,70	●	●	●										
		DNMG 150608-MRP	15,50	12,70	●	●	●										
		DNMG 150612-MRP	15,50	12,70	●	●	●										
		DNMG 150616-MRP	15,50	12,70	●	●	●										
	DNMG....-MM	DNMG 110404-MM	11,60	9,52													
		DNMG 110408-MM	11,60	9,52													
		DNMG 150404-MM	15,50	12,70													
		DNMG 150408-MM	15,50	12,70													
		DNMG 150604-MM	15,50	12,70													
		DNMG 150608-MM	15,50	12,70													
		DNMG 150612-MM	15,50	12,70													
	DNMG....-MS	DNMG 150404-MS	15,50	12,70												●	
		DNMG 150408-MS	15,50	12,70												●	
		DNMG 150412-MS	15,50	12,70												●	
		DNMG 150604-MS	15,50	12,70												●	
		DNMG 150608-MS	15,50	12,70												●	
		DNMG 150612-MS	15,50	12,70												●	
	DNMG...MT	DNMG 150608-MT	15,50	12,70												●	●
	DNMG....-	DNMG 140405TL20	14,00	11,95	●	●											
		DNMG 140405TR20	14,00	11,95	●	●											
		DNMG 140405TL25	14,00	11,95	●	●											
		DNMG 140405TR25	14,00	11,95	●	●											
		DNMG 140410TL25	14,00	11,95	●	●											
		DNMG 140410TR25	14,00	11,95	●	●											

Bestellbeispiel Order example: 10 Stück 10 pieces DNMG 150408-MRP LCP15T



● Verfügbar ab Lager Available from stock

Werkzeuge siehe Seiten 64 / 69 / 91

For tool holders see pages 64 / 69 / 91

Schnittdatenrichtwerte siehe ab Seite 110

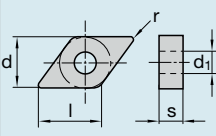
For cutting data standard values see from page 110

	Bestellbezeichnung Ordering Code	Sorte Grade																
		I	IC	HC				HW	HC	HW	HC							
				LCP15T	LCP25T	LC240F	LCM20T	LC435D	BCM25T	BCM40T	LC610H	LC620H	LW611	LC610T	LW610	LC415X	LC415Z	BCS10T
	DNMM 150608-RP	15,50	12,70	●	●	●												
	DNMM 150612-RP	15,50	12,70	●	●	●												
	DNMM 150616-RP	15,50	12,70	●	●	●												

Bestellbeispiel Order example: 10 Stück 10 pieces DNMM 150608-RP LCP15T

● Verfügbar ab Lager Available from stock

Werkzeuge siehe Seiten 64 / 69/ 91

For tool holders see pages 64 / 69 / 91

Schnittdatenrichtwerte siehe ab Seite 110

For cutting data standard values see from page 110

	Bestellbezeichnung Ordering Code	Sorte Grade																
		I	IC	HC				HW	HC	HW	HC							
				LCP15T	LCP25T	LC240F	LCM20T	LC435D	BCM25T	BCM40T	LC610H	LC620H	LW611	LC610T	LW610	LC415X	LC415Z	BCS10T
	RCGT 0602MO-BAL		6,00										●	●				
	RCGT 0803MO-BAL		8,00										●	●				
	RCGT 1003MO-BAL		10,00										●	●				
	RCMT 0602MO		6,00										●					
	RCMT 1606-MT		16,00														●	
	RCMT 2006-MT		20,00														●	

Bestellbeispiel Order example: 10 Stück 10 pieces RCGT 0602MO-BAL LC610T



● Verfügbar ab Lager Available from stock

Werkzeuge siehe Seiten 70 / 80

For tool holders see pages 70 / 80

Schnittdatenrichtwerte siehe ab Seite 110

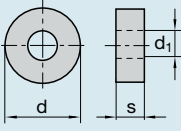

For cutting data standard values see from page 110

	Bestellbezeichnung Ordering Code	I IC		Sorte Grade													
				HC				HW	HC	HW	HC						
				LCP15T	LCP25T	LC240F	LCM20T	LC435D	BCM25T	BCM40T	LC610H	LC620H	LW611	LC610T	LW610	LC415X	LC415Z
	RCMX 1003MO	10,00															
	RCMX 1204MO	12,00															
	RCMX 1606MO	16,00															
	RCMX 2006MO	20,00															
	RCMX 2507MO	25,00															
	RCMX 3209MO	32,00															

Bestellbeispiel Order example: 10 Stück 10 pieces RCMX 1003MO LC240F

● Verfügbar ab Lager Available from stock

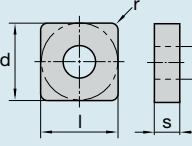
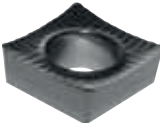
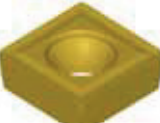



Werkzeuge siehe Seiten 70 / 80
For tool holders see pages 70 / 80
Schnittdatenrichtwerte siehe ab Seite 110
For cutting data standard values see from page 110

	Bestellbezeichnung Ordering Code	I IC		Sorte Grade													
				HC				HW	HC	HW	HC						
				LCP15T	LCP25T	LC240F	LCM20T	LC435D	BCM25T	BCM40T	LC610H	LC620H	LW611	LC610T	LW610	LC415X	LC415Z
	SCGT 120408-BAL	12,70	12,70														
	SCMT 120404	12,70	12,70														
	SCMT 09T308-BSM	9,52	9,52														
	SCMT 120408-BSM	12,70	12,70														

Bestellbeispiel Order example: 10 Stück 10 pieces SCGT 120408-BAL LC610T

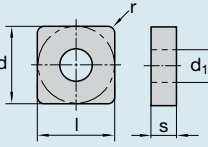
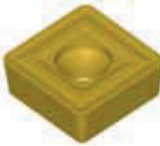
● Verfügbar ab Lager Available from stock

Werkzeuge siehe Seiten 81 - 82
For tool holders see pages 81 - 82
Schnittdatenrichtwerte siehe ab Seite 110
For cutting data standard values see from page 110

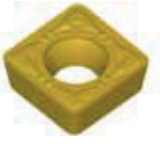
	Bestellbezeichnung Ordering Code			Sorte Grade															
		I	IC	HC				HW	HC	HW	HC								
				LCP15T	LCP25T	LC240F	LCM20T	LC435D	BCM25T	BCM40T	LC610H	LC620H	LW611	LC610T	LW610	LC415X	LC415Z	BCS10T	BCS20T
SCMT....-BSMR 	SCMT 250924-BSMR	25,40	25,40	●	●	●													
SCMT....-BSMS 	SCMT 120408-BSMS	12,70	12,70				●												
SCMT....-BSR 	SCMT 250916-BSR	25,40	25,40	●	●	●				●									
	SCMT 250924-BSR	25,40	25,40	●	●	●				●									
SCMT....-FP 	SCMT 09T304-FP	9,52	9,52	●	●														
	SCMT 09T308-FP	9,52	9,52	●	●														
	SCMT 120404-FP	12,70	12,70	●	●														
SCMT....-MP 	SCMT 09T308-MP	9,52	9,52	●	●														
	SCMT 120408-MP	12,70	12,70	●	●														
	SCMT 120412-MP	12,70	12,70	●	●														

Bestellbeispiel Order example: 10 Stück 10 pieces SCMT 250924-BSMR LCP15T

● Verfügbar ab Lager Available from stock

Werkzeuge siehe Seiten 81-82

For tool holders see pages 81-82

Schnittdatenrichtwerte siehe ab Seite 110



For cutting data standard values see from page 110

	Bestellbezeichnung Ordering Code	l	IC	Sorte Grade														
				HC				HW	HC	HW	HC							
				LCP15T	LCP25T	LC240F	LCM20T	LC435D	BCM25T	BCM40T	LC610H	LC620H	LW611	LC610T	LW610	LC415X	LC415Z	BCS10T
SCMW... 	SCMW 09T304	9,52	9,52								●							
	SCMW 120404	12,70	12,70								●							
SNMA... 	SNMA 120408	12,70	12,70								●	●						
	SNMA 120412	12,70	12,70								●	●						
	SNMA 120416	12,70	12,70								●	●						
	SNMA 190616	19,05	19,05									●						
	SNMA 250724	25,40	25,40									●						
SNMG...-BFMS 	SNMG 090304-BFMS	9,52	9,52					●	●									
SNMG...-BMR 	SNMG 120408-BMR	12,70	12,70								●	●						
	SNMG 120412-BMR	12,70	12,70								●	●						
	SNMG 190612-BMR	19,05	19,05								●							
	SNMG 190616-BMR	19,05	19,05								●	●						
	SNMG 250924-BMR	25,40	25,40				●											
SNMG...-BMRS 	SNMG 120408-BMRS	12,70	12,70					●										
	SNMG 120412-BMRS	12,70	12,70					●	●									
	SNMG 190612-BMRS	19,05	19,05					●	●									
	SNMG 190616-BMRS	19,05	19,05						●									

Bestellbeispiel Order example: 10 Stück 10 pieces SCMW 09T304 LW611

● Verfügbar ab Lager Available from stock

Werkzeuge siehe Seiten 64 / 66 / 71-72 / 81-82 / 92
For tool holders see pages 64 / 66 / 71-72 / 81-82 / 92
Schnittdatenrichtwerte siehe ab Seite 110
For cutting data standard values see from page 110

	Bestellbezeichnung Ordering Code	l	IC	Sorte Grade															
				HC				HW	HC	HW	HC								
				LCP15T	LCP25T	LC240F	LCM20T	LC435D	BCM25T	BCM40T	LC610H	LC620H	LW611	LC610T	LW610	LC415X	LC415Z	BCS10T	BCS20T
SNMG....-MP 	SNMG 120408-MP	12,70	12,70	●	●	●													
	SNMG 120412-MP	12,70	12,70	●	●	●													
	SNMG 150608-MP	15,87	15,87	●	●	●													
	SNMG 190612-MP	19,05	19,05	●	●	●													
SNMG...-MRP 	SNMG 120408-MRP	12,70	12,70	●	●	●													
	SNMG 120412-MRP	12,70	12,70	●	●	●													
	SNMG 190612-MRP	19,05	19,05	●	●	●													
	SNMG 190616-MRP	19,05	19,05	●	●	●													
SNMG....-MRS 	SNMG 120408-MRS	12,70	12,70												●				
	SNMG 120412-MRS	12,70	12,70												●				
SNMM...-BR 	SNMM 190616-BR	19,05	19,05	●	●	●													
	SNMM 190624-BR	19,05	19,05	●	●	●													
	SNMM 250724-BR	25,40	25,40	●	●														
	SNMM 250924-BR	25,40	25,40	●	●														
SNMM...-BRP 	SNMM 250724-BRP	25,40	25,40	●	●	●				●									
	SNMM 250732-BRP	25,40	25,40	●	●	●													
	SNMM 250924-BRP	25,40	25,40	●	●	●				●									
	SNMM 250932-BRP	25,40	25,40	●	●	●													

Bestellbeispiel Order example: 10 Stück 10 pieces SNMG 120408-MP LCP15T



● Verfügbar ab Lager Available from stock

Werkzeuge siehe Seiten 64 / 66 / 71 / 72 / 92

For tool holders see pages 64 / 66 / 71 / 72 / 92

Schnittdatenrichtwerte siehe ab Seite 110

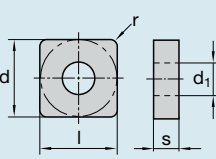
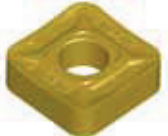
For cutting data standard values see from page 110

	Bestellbezeichnung Ordering Code	I IC		Sorte Grade														
				HC				HW	HC	HW	HC							
				LCP15T	LCP25T	LC240F	LCM20T	LC435D	BCM25T	BCM40T	LC610H	LC620H	LW611	LC610T	LW610	LC415X	LC415Z	BCS10T
SNMM....-RP 	SNMM 120408-RP	12,70	12,70	●	●	●												
	SNMM 120412-RP	12,70	12,70	●	●	●												
	SNMM 150612-RP	15,87	15,87	●	●	●												
	SNMM 150616-RP	15,87	15,87	●	●	●												
	SNMM 190612-RP	19,05	19,05	●	●	●												
	SNMM 190616-RP	19,05	19,05	●	●	●												
	SNMM 190624-RP	19,05	19,05	●	●	●												
	SNMM 190632-RP	19,05	19,05	●	●	●												
	SNMM 250724-RP	25,40	25,40	●														
SNMM.... 	SNMM 250716	25,40	25,40			●												
	SNMM 250724	25,40	25,40		●	●												

Bestellbeispiel Order example: 10 Stück 10 pieces SNMM 120408-MP LCP15T



● Verfügbar ab Lager Available from stock

Werkzeuge siehe Seiten 64 / 66 / 71 / 72 / 92

For tool holders see pages 64 / 66 / 71 / 72 / 92

Schnittdatenrichtwerte siehe ab Seite 110

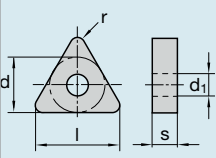
For cutting data standard values see from page 110

	Bestellbezeichnung Ordering Code	I IC		Sorte Grade													
				HC				HW	HC	HW	HC						
				LCP15T	LCP25T	LC240F	LCM20T	LC435D	BCM25T	BCM40T	LC610H	LC620H	LW611	LC610T	LW610	LC415X	LC415Z
TCGT....-BAL 	TCGT 110204-BAL	11,00	6,35									●	●				
	TCGT 16T304-BAL	16,50	9,52									●	●				
TCGT....-E.-BC 	TCGT 110204 EL-BC	11,00	6,35	●	●		●										
	TCGT 110204 ER-BC	11,00	6,35	●	●		●										
	TCGT 16T304 EL-BC	16,50	9,52	●	●		●										
	TCGT 16T304 ER-BC	16,50	9,52	●	●		●										
	TCGT 16T308 EL-BC	16,50	9,52	●	●		●										
	TCGT 16T308 ER-BC	16,50	9,52	●	●		●										

Bestellbeispiel Order example: 10 Stück 10 pieces TCGT 110204-BAL LC610T



● Verfügbar ab Lager Available from stock

Werkzeuge siehe Seiten 83-84 / 96

For tool holders see pages 83-84 / 96

Schnittdatenrichtwerte siehe ab Seite 110

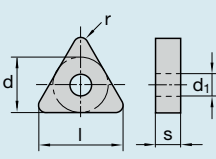

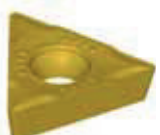
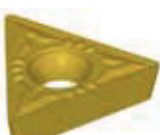
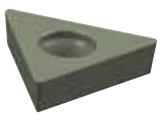
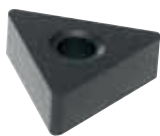

For cutting data standard values see from page 110

	Bestellbezeichnung Ordering Code	l	IC	Sorte Grade													
				HC				HW	HC	HW	HC						
				LCP15T	LCP25T	LC240F	LCM20T	LC435D	BCM25T	BCM40T	LC610H	LC620H	LW611	LC610T	LW610	LC415X	LC415Z
TCMT....-BSMS 	TCMT 110204-BSMS	11,00	6,35					●									
	TCMT 110208-BSMS	11,00	6,35					●									
	TCMT 16T304-BSMS	16,50	9,52					●									
	TCMT 16T308-BSMS	16,50	9,52					●									
TCMT....-F. 	TCMT 110202-FP	11,00	6,35	●	●												
	TCMT 110204-FP	11,00	6,35	●	●												
TCMT....-MP 	TCMT 110204-MP	11,00	6,35	●	●												
	TCMT 110208-MP	11,00	6,35	●	●												
	TCMT 16T304-MP	16,50	9,52	●	●												
	TCMT 16T308-MP	16,50	9,52	●	●												
TCMW... 	TCMW 110204	11,00	6,35							●							
	TCMW 16T304	16,50	9,52							●							
TNMA... 	TNMA 160408	16,50	9,52						●	●							
	TNMA 160412	16,50	9,52						●	●							
	TNMA 220416	22,00	12,70						●	●							

Bestellbeispiel Order example: 10 Stück 10 pieces TCMT 110204-BSMS LC435D

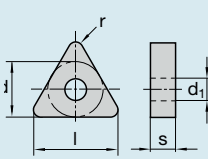
● Verfügbar ab Lager Available from stock

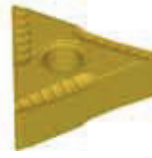
Werkzeuge siehe Seiten 65-66 / 73 / 83-84 / 92 / 96
For tool holders see pages 65-66 / 73 / 83-84 / 92 / 96
Schnittdatenrichtwerte siehe ab Seite 110
For cutting data standard values see from page 110

			Sorte Grade														
			HC				HW	HC	HW	HC							
			LCP15T	LCP25T	LC240F	LCM20T	LC435D	BCM25T	BCM40T	LC610H	LC620H	LW611	LC610T	LW610	LC415X	LC415Z	BCS10T
I	IC																
TNMG...-BFMS 	TNMG 160404-BFMS	16,50	9,52														
	TNMG 160408-BFMS	16,50	9,52														
TNMG...-BMS 	TNMG 160408-BMS	16,50	9,52														
	TNMG 160412-BMS	16,50	9,52														
	TNMG 220408-BMS	22,00	12,70														
	TNMG 220412-BMS	22,00	12,70														
TNMG...-E.-BC 	TNMG 160404 EL-BC	16,50	9,52	●	●	●	●										
	TNMG 160404 ER-BC	16,50	9,52	●	●	●	●										
	TNMG 160408 EL-BC	16,50	9,52	●	●	●	●										
	TNMG 160408 ER-BC	16,50	9,52	●	●	●	●										
TNMG...-FMP 	TNMG 160404-FMP	16,50	9,52	●	●	●											
	TNMG 160408-FMP	16,50	9,52	●	●	●											
	TNMG 160412-FMP	16,50	9,52	●	●												
TNMG...-FP 	TNMG 160404 FP	16,50	9,52	●	●												
	TNMG 160408 FP	16,50	9,52	●	●												

Bestellbeispiel Order example: 10 Stück 10 pieces TNMG 160404-BFMS LC435D





● Verfügbar ab Lager Available from stock

Werkzeuge siehe Seiten 65-66 / 73 / 92

For tool holders see pages 65-66 / 73 / 92

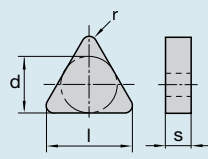
Schnittdatenrichtwerte siehe ab Seite 110

For cutting data standard values see from page 110

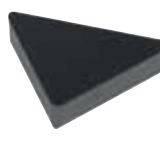
	Bestellbezeichnung Ordering Code	Sorte Grade																	
		l	IC	HC				HW	HC	HW	HC								
				LCP15T	LCP25T	LC240F	LCM20T	LC435D	BCM25T	BCM40T	LC610H	LC620H	LW611	LC610T	LW610	LC415X	LC415Z	BCS10T	BCS20T
TNMG....-MP 	TNMG 160408-MP	16,50	9,52	●	●	●													
	TNMG 160412-MP	16,50	9,52	●	●	●													
	TNMG 160416-MP	16,50	9,52	●	●	●													
	TNMG 220408-MP	22,00	12,70	●	●	●													
	TNMG 220412-MP	22,00	12,70	●	●														
TNMM....-RP 	TNMM 160408-RP	16,50	9,52	●	●	●													
	TNMM 220408-RP	22,00	12,70	●	●	●													
	TNMM 220412-RP	22,00	12,70	●	●	●													
TPMR....-FM 	TPMR 110304-FM	11,00	6,35	●	●	●													
	TPMR 110308-FM	11,00	6,35	●	●	●													
	TPMR 160304-FM	16,50	9,52	●	●	●													
	TPMR 160308-FM	16,50	9,52	●	●	●													
TPUN... 	TPUN 160308	16,50	9,52												●				

Bestellbeispiel Order example: 10 Stück 10 pieces TNMG 160408-MP LCP15T





● Verfügbar ab Lager Available from stock

Werkzeuge siehe Seiten 65-66 / 73 / 92 / 99

For tool holders see pages 65-66 / 73 / 92 / 99

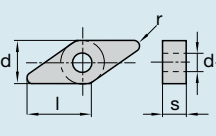
Schnittdatenrichtwerte siehe ab Seite 110

For cutting data standard values see from page 110

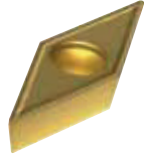
	Bestellbezeichnung Ordering Code	Sorte Grade																	
		l	IC	HC				HW	HC	HW	HC								
				LCP15T	LCP25T	LC240F	LCM20T	LC435D	BCM25T	BCM40T	LC610H	LC620H	LW611	LC610T	LW610	LC415X	LC415Z	BCS10T	BCS20T
	VBMT 160404	16,60	9,52	●	●														
	VBMT 160408	16,60	9,52	●	●														
	VBMT 160412	16,60	9,52	●	●														
	VBMT 160404-MM	16,60	9,52							●	●								
	VBMT 160408-MM	16,60	9,52							●	●								
	VCGT 070202-P	6,85	3,97												●				
	VCGT 070204-P	6,85	3,97												●				
	VCGT 110302-P	11,10	6,37												●				
	VCGT 110304-P	11,10	6,37												●				
	VCGT 1103008	11,10	6,35													●			
	VCGT 1103015	11,10	6,35													●			
	VCGT 110302-BAL	11,10	6,35												●	●			
	VCGT 110304-BAL	11,10	6,35												●	●			
	VCGT 160402-BAL	16,60	9,52												●	●			
	VCGT 160404-BAL	16,60	9,52												●	●			
	VCGT 160408-BAL	16,60	9,52												●	●			
	VCGT 160412-BAL	16,60	9,52												●	●			
	VCGT 220530-BAL	22,10	12,70												●	●			
	VCMT 160404-BSMS	16,60	9,52													●			
	VCMT 160408-BSMS	16,60	9,52													●			
	VCMT 160412-BSMS	16,60	9,52													●			

Bestellbeispiel Order example: 10 Stück 10 pieces VBMT 160404 LCP15T







● Verfügbar ab Lager Available from stock

Werkzeuge siehe Seiten 85-87 / 96 - 97

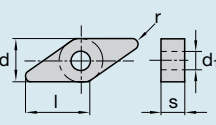
For tool holders see pages 85-87 / 96 - 97

Schnittdatenrichtwerte siehe ab Seite 110



For cutting data standard values see from page 110



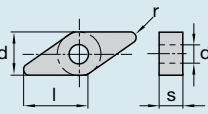

	Bestellbezeichnung Ordering Code	Sorte Grade																
		l	IC	HC				HW	HC	HW	HC							
				LCP15T	LCP25T	LC240F	LCM20T	LC435D	BCM25T	BCM40T	LC610H	LC620H	LW611	LC610T	LW610	LC415X	LC415Z	BCS10T
	VCMT 110304-FP	11,10	6,35	●	●													
	VCMT 160404-FP	16,60	9,52	●	●													
	VCMT 160408-FP	16,60	9,52	●	●													
	VCMT 160404-MP	16,60	9,52	●	●													
	VCMT 160408-MP	16,60	9,52	●	●													
	VCMT 160404-MM	16,60	9,52															
	VCMT 160408-MM	16,60	9,52															
	VCMT 160412-MM	16,60	9,52															
	VNMG 160404-FP	16,60	9,52	●	●													
	VNMG 160408-FP	16,60	9,52	●	●													
	VNMG 160408-FMP	16,60	9,52	●	●													
	VNMG 160404-FMS	16,60	9,52															●
	VNMG 160408-FMS	16,60	9,52															●

Bestellbeispiel Order example: 10 Stück 10 pieces VCMT 110304-FP LCP15T

● Verfügbar ab Lager Available from stock

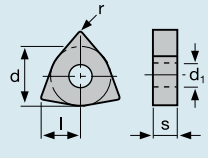
Werkzeuge siehe Seiten 85-87 / 96-97
For tool holders see pages 85-87 / 96-97
Schnittdatenrichtwerte siehe ab Seite 110
For cutting data standard values see from page 110

	Bestellbezeichnung Ordering Code		Sorte Grade																
			l	IC	HC				HW	HC	HW	HC							
					LCP15T	LCP25T	LC240F	LCM20T	LC435D	BCM25T	BCM40T	LC610H	LC620H	LW611	LC610T	LW610	LC415X	LC415Z	BCS10T
	VNMG 160408-MP	16,60 9,52	●	●	●														
	VNMG 160412-MP	16,60 9,52	●	●	●														
VPGT....-BAL	VPGT 220516-BAL	22,10 12,70												●					

	Bestellbezeichnung Ordering Code		Sorte Grade																
			l	IC	HC				HW	HC	HW	HC							
					LCP15T	LCP25T	LC240F	LCM20T	LC435D	BCM25T	BCM40T	LC610H	LC620H	LW611	LC610T	LW610	LC415X	LC415Z	BCS10T
	WCGT 06T302-BAL	6,50 9,52												●					
	WCGT 06T304-BAL	6,50 9,52												●	●				
	WCGT 06T308-BAL	6,50 9,52												●	●				
	WCGT 080404-BAL	8,60 12,70													●				
	WCGT 080408-BAL	8,60 12,70												●	●				
	WNGG 060408-FMS	6,50 9,52																●	
	WNGG 080404-FMS	8,60 12,70																●	
	WNGG 080408-FMS	8,60 12,70																●	
	WNGG 080412-FMS	8,60 12,70																●	
	WNGG 080404-MS	8,60 12,70																●	
	WNGG 080408-MS	8,60 12,70																●	
	WNGG 080412-MS	8,60 12,70																●	

Bestellbeispiel Order example: 10 Stück 10 pieces VNMG 160408-MP LCP15T



● Verfügbar ab Lager Available from stock

Werkzeuge siehe Seiten 65 / 67 / 74 / 93

For tool holders see pages 65 / 67 / 74 / 93

Schnittdatenrichtwerte siehe ab Seite 110

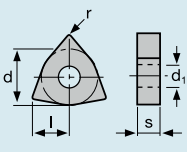
For cutting data standard values see from page 110

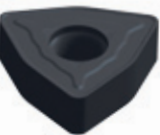
	Bestellbezeichnung Ordering Code	I IC		Sorte Grade													
				HC				HW	HC	HW	HC						
				LCP15T	LCP25T	LC240F	LCM20T	LC435D	BCM25T	BCM40T	LC610H	LC620H	LW611	LC610T	LW610	LC415X	LC415Z
WNMA... 	WNMA 080408	8,60	12,70														
	WNMA 080412	8,60	12,70														
WNMG...-BFMS 	WNMG 060404-BFMS	6,50	9,52					●									
	WNMG 080404-BFMS	8,60	12,70					●	●								
	WNMG 080408-BFMS	8,60	12,70					●	●								
WNMG...-BMR 	WNMG 080408-BMR	8,60	12,70						●	●							
	WNMG 080412-BMR	8,60	12,70							●							
WNMG...-BMRS 	WNMG 080408-BMRS	8,60	12,70					●	●	●							
	WNMG 080412-BMRS	8,60	12,70					●	●	●							
WNMG...-BMS 	WNMG 060408-BMS	6,50	9,52					●									
	WNMG 080408-BMS	8,60	12,70					●									
	WNMG 080412-BMS	8,60	12,70					●									
	WNMG 080416-BMS	8,60	12,70					●									

Bestellbeispiel Order example: 10 Stück 10 pieces WNMA 080408 LC610H







● Verfügbar ab Lager Available from stock

Werkzeuge siehe Seiten 65 / 67 / 74 / 93

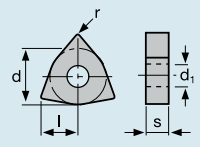
For tool holders see pages 65 / 67 / 74 / 93

Schnittdatenrichtwerte siehe ab Seite 110

For cutting data standard values see from page 110

	Bestellbezeichnung Ordering Code	Sorte Grade																
		l	IC	HC				HW	HC	HW	HC							
				LCP15T	LOP25T	LC240F	LCM20T	LC435D	BCM25T	BCM40T	LC610H	LC620H	LW611	LC610T	LW610	LC415X	LC415Z	BCS10T
WNMG...-E-BC 	WNMG 080404 ER-BC	8,60	12,70	●	●	●	●											
	WNMG 080408 EL-BC	8,60	12,70	●	●	●	●											
	WNMG 080408 ER-BC	8,60	12,70	●	●	●	●											
	WNMG 080412 EL-BC	8,60	12,70	●	●	●	●											
	WNMG 080412 ER-BC	8,60	12,70	●	●	●	●											
WNMG....-FMP 	WNMG 060404-FMP	6,50	9,52	●	●	●												
	WNMG 060408-FMP	6,50	9,52	●	●	●												
	WNMG 080404-FMP	8,60	12,70	●	●	●												
	WNMG 080408-FMP	8,60	12,70	●	●	●												
	WNMG 080412-FMP	8,60	12,70	●	●	●												
WNMG....-HPT 	WNMG 080408-HPT	8,60	12,70	●	●													
	WNMG 080412-HPT	8,60	12,70	●	●													
WNMG....-MM 	WNMG 060404-MM	6,50	9,52								●							
	WNMG 080408-MM	8,60	12,70				●				●							
	WNMG 080412-MM	8,60	12,70				●				●							
	WNMG 080416-MM	8,60	12,70								●							
WNMG....-MP 	WNMG 060408-MP	8,60	9,52	●	●	●												
	WNMG 080408-MP	8,60	12,70	●	●	●												
	WNMG 080412-MP	8,60	12,70	●	●	●												
	WNMG 080416-MP	8,60	12,70	●	●	●												

Bestellbeispiel Order example: 10 Stück 10 pieces WNMG 080404 ER-BC LCP15T



● Verfügbar ab Lager Available from stock

Werkzeuge siehe Seiten 65 / 67 / 74 / 93

For tool holders see pages 65 / 67 / 74 / 93

Schnittdatenrichtwerte siehe ab Seite 110

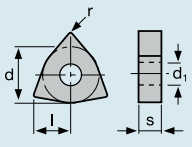
For cutting data standard values see from page 110

	Bestellbezeichnung Ordering Code		Sorte Grade																
			l	IC	HC				HW	HC	HW	HC							
					LCP15T	LCP25T	LC240F	LCM20T	LC435D	BCM25T	BCM40T	LC610H	LC620H	LW611	LC610T	LW610	LC415X	LC415Z	BCS10T
WNMG...-MRP 	WNMG 080408-MRP	8,60	12,70	●	●	●													
	WNMG 080412-MRP	8,60	12,70	●	●	●													
	WNMG 080416-MRP	8,60	12,70	●	●	●													
WNMG...-MS 	WNMG 080404-MS	8,60	12,70															●	
	WNMG 080408-MS	8,60	12,70															●	
	WNMG 080412-MS	8,60	12,70															●	
WNMG...MT 	WNMG 080408-MT	8,60	12,70															●	●

Bestellbeispiel Order example: 10 Stück 10 pieces WNMG 080408-MRP LCP15T



- Verfügbar ab Lager Available from stock

Werkzeuge siehe Seiten 65 / 67 / 74 / 93

For tool holders see pages 65 / 67 / 74 / 93

Schnittdatenrichtwerte siehe ab Seite 110

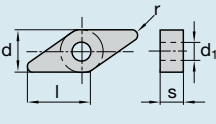
For cutting data standard values see from page 110

	Bestellbezeichnung Ordering Code		Sorte Grade																
			l	IC	HC				HW	HC	HW	HC							
					LCP15T	LCP25T	LC240F	LCM20T	LC435D	BCM25T	BCM40T	LC610H	LC620H	LW611	LC610T	LW610	LC415X	LC415Z	BCS10T
XCGT...-P 	XCGT 260407-P		9,52															●	
	XCGT 260410-P		9,52															●	
	XCGT 280408-P		9,45															●	

Bestellbeispiel Order example: 10 Stück 10 pieces XCGT 260407-P LW610

- Verfügbar ab Lager Available from stock

Werkzeuge siehe Seiten 89

For tool holders see pages 89

Schnittdatenrichtwerte siehe ab Seite 110

For cutting data standard values see from page 110

BOEHLERIT

Klemmhalter
Tool holder

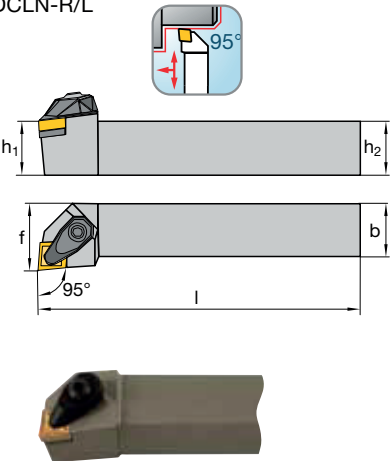
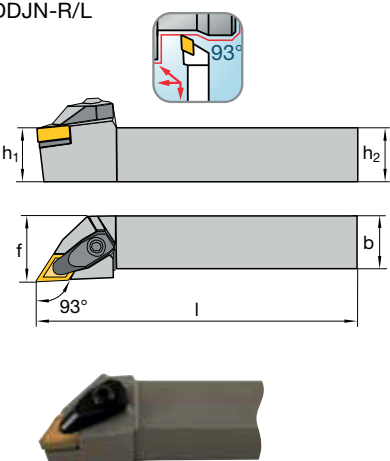
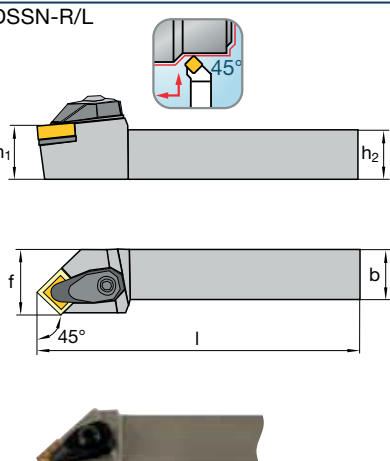

	Bestellbezeichnung Ordering Code	Ident No.	h_1 = h_2	b	f	l	Passende Wende- platten Suitable inserts	Seite Page
DCLN-R/L 	DCLNR/L 2020 K12	5009529 / 5009531	20	20	25	125	CN... 1204..	36-40
	DCLNR/L 2525 M12	5009454 / 5009455	25	25	25	125		
DDJN-R/L 	DDJNR/L 2020 K15	5009527 / 5009528	20	20	25	125	DN... 1506..	42-46
	DDJNR/L 2525 M15	5009452 / 5009453	25	25	25	125		
DSSN-R/L 	DSSNR/L 2020 K12	5009462 / 5009463	20	20	25	125	SN... 1204..	49-52
	DSSNR/L 2525 M12	5009456 / 5009457	25	25	25	125		

Rechtsausführung wie gezeichnet, Linksausführung spiegelbildlich
 Righthand version as shown, lefthand version mirrorlike



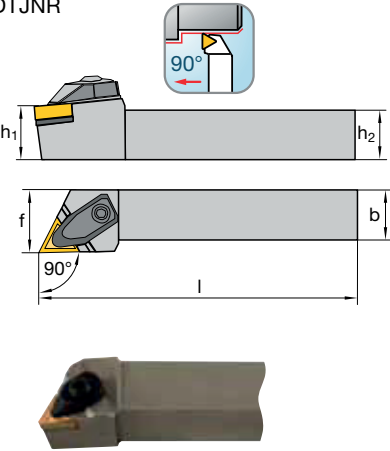
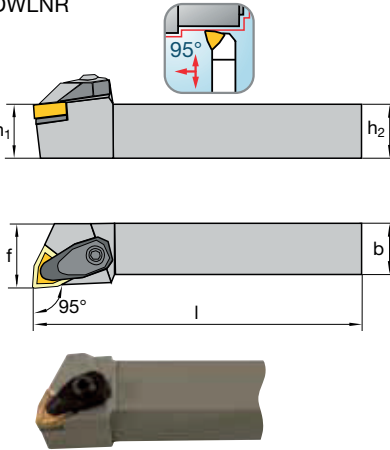



Bestellbeispiel: 1 Stück DCLNR 2020 K12
 Order example: 1 piece DCLNR 2020 K12

	Bestellbezeichnung Ordering Code	Ident No.	h_1 = h_2	b	f	l	Passende Wende- platten Suitable inserts	Seite Page
DTJNR 	DTJNR/L 2020 K16	5009460 / 5009461	20	20	25	125	TN... 1604..	53-55
	DTJNR/L 2525 M16	5009285 / 5009451	25	25	25	125		
DWLNR 	DWLNR/L 2020 K08	5009459 / 5009458	20	20	25	125	WN... 0804..	58-61
	DWLNR/L 2525 M08	5009284 / 5009283	25	25	25	125		

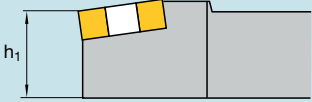
Rechtsausführung wie gezeichnet, Linksausführung spiegelbildlich
 Righthand version as shown, lefthand version mirrorlike

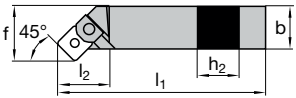
Ersatzteile Spare parts	Bestellbezeichnung Ordering Code									
										
		M6210	V6020	V01-A0030						
DCLNR/L 2020 K12	5013589	DT01N	5013609	5013595	5013610	5013607	VD0408	5013600	S8012P	
DCLNR/L 2525 M12	5013589	DT01N	5013609	5013595	5013610	5013607	VD0408	5013600	S8012P	
DDJNR/L 2020 K15	5013591	DT02N	5013609	5013595	5013610	5013607	VD0408	5013601	S5515P	
DDJNR/L 2525 M15	5013591	DT02N	5013609	5013595	5013610	5013607	VD0408	5013601	S5515P	
DSSNR/L 2020 K12	5013589	DT01N	5013609	5013595	5013610	5013607	VD0408	5013604	S9012P	
DSSNR/L 2525 M12	5013589	DT01N	5013609	5013595	5013610	5013607	VD0408	5013604	S9012P	
DTJNR/L 2020 K16	5013594	DT03N	5013609	5013595	5013610	5013608	VD0308	5013602	S6016D	
DTJNR/L 2525 M16	5013594	DT03N	5013609	5013595	5013610	5013608	VD0308	5013602	S6016D	
DWLNR/L 2020 K08	5013589	DT01N	5013609	5013595	5013610	5030344	VD0408B	5013603	S8008P	
DWLNR/L 2525 M08	5013589	DT01N	5013609	5013595	5013610	5030344	VD0408B	5013603	S8008P	

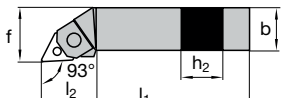
Bestellbeispiel: 1 Stück DTJNR 2020 K16
 Order example: 1 piece DTJNR 2020 K16

	Bestellbezeichnung Ordering Code	Ident No.	h₁ = h₂	b	l₁	l₂	f	Passende Wende- platten Suitable inserts	Seite Page
MSSN-R/L   	MSSNR/L 3232P19	6406095 / 6406094	32	32	170	44	40	SN.. 19..	49-52
MTJN-R/L   	MTJNR/L 2020K16 MTJNR/L 2525M16 MTJNR/L 2525M22 MTJNR/L 3225P22	6406122 / 6406118 6406123 / 6406119 6406124 / 6406120 6406125 / 6406121	20 25 25 32	20 25 25 25	125 150 150 170	34 34 35 35	25 32 32 32	TN.. 16.. TN.. 22..	53-55 53-55

Rechtsausführung wie gezeichnet, Linksausführung spiegelbildlich
 Righthand version as shown, lefthand version mirrorlike





Ersatzteile Spare parts		Bestellbezeichnung Ordering Code				
Schneid- kantenlänge Cutting edge length	Schaftgröße Shank size	 Unterlage Shim	 Spannpratzen- satz Clampset	 Schraube Screw	 Stift Pin	 Schlüssel Key
	19	3232	B08-S1847	D08-S19SP	A11-05008	E08-07925

Ersatzteile Spare parts		Bestellbezeichnung Ordering Code				
Schneid- kantenlänge Cutting edge length	Schaftgröße Shank size	 Unterlage Shim	 Spannpratzen- satz Clampset	 Gewindestift Threadpin	 Stift Pin	 Schlüssel Key
	16	2020–2525	B08-13416	D08-12016*	-	E08-11645
22	2525–3225	B08-T2047	D08-T22SP	A01-06100	E08-051K8	V01-A0030



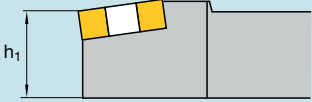

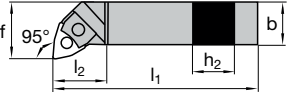
Bestellbeispiel: 1 Stück MSSNR 3232P19
 Order example: 1 piece MSSNR 3232P19

Lieferung ohne Schlüssel
 Delivery without key

* Spannpratze und Schraube Sonderausführung/Set
 Clampset with screw special edition/set

	Bestellbezeichnung Ordering Code	Ident No.	h₁ = h₂	b	l₁	l₂	f	Passende Wende- platten Suitable inserts	Seite Page
MWLN-R/L   	MWLN-R/L 2020K06	6406136 / 6406127	20	20	125	26	25	WN.. 06..	58-61
	MWLN-R/L 2525M06	6406139 / 6406130	25	25	150	26	32		
	MWLN-R/L 3225P06	6406142 / 6406133	32	25	170	26	32		
	MWLN-R/L 2020K08	6406138 / 6406129	20	20	125	34	25	WN.. 08..	58-61
	MWLN-R/L 2525M08	6406141 / 6406132	25	25	150	34	32		
	MWLN-R/L 3225P08	6406143 / 6406134	32	25	170	34	32		







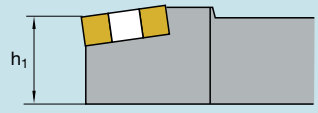

Rechtsausführung wie gezeichnet, Linksausführung spiegelbildlich
 Righthand version as shown, lefthand version mirrorlike

Ersatzteile Spare parts		Bestellbezeichnung Ordering Code				
Schneid- kantenlänge Cutting edge length	Schaftgröße Shank size					
		Unterlage Shim	Spannpratzen- satz Clampset	Schraube Screw	Stift Pin	Schlüssel Key
06	2020-3225	B08-W0632	D08-W06SP	A14-30006	E08-05610	V01-A0020
08	2020-3225	B01-W0831	D08-12008*	-	E08-11662	V01-A0025

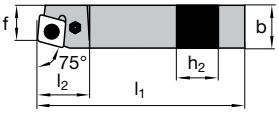

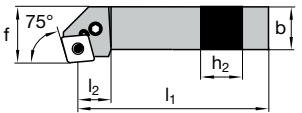

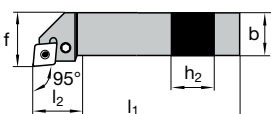

Bestellbeispiel: 1 Stück MWLN-R 2020K06
 Order example: 1 piece MWLN-R 2020K06

Lieferung ohne Schlüssel
 Delivery without key

* Spannpratze und Schraube Sonderausführung/Set
 Clampset with screw special edition/set







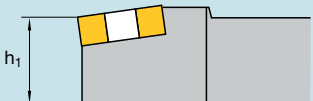

	Bestellbezeichnung Ordering Code	Ident No.	h₁ = h₂	b	l₁	l₂	f	Passende Wende- platten Suitable inserts	Seite Page
PCBN-R/L   	PCBNR/L 2525M12	6406213 / 6406210	25	25	150	27,7	22	CN.. 12..	36-40
	PCBNR/L 2525M16	6406214 / 6406211	25	25	150	31,7	22	CN.. 16..	36-40
	PCBNR/L 3232P19	6406216 / 6406212	32	32	170	37,9	27	CN.. 19..	36-40
PCKN-R/L   	PCKNR/L 2525M12	6406219 / 6406217	25	25	150	28	32	CN.. 12..	36-40
	PCKNR/L 3232P19	6406220 / 6406218	32	32	170	36	40	CN.. 19..	36-40
PCLN-R/L   	PCLNR/L 1616H09	6406232 / 6406221	16	16	100	23	20	CN.. 09..	36-40
	PCLNR/L 1616H12	6406233 / 6406222	16	16	100	26,1	20	CN.. 12..	36-40
	PCLNR/L 2020K12	6406234 / 6406223	20	20	125	27,4	25		
	PCLNR/L 2525M12	6406235 / 6406224	25	25	150	28	32		
	PCLNR/L 3225P12	6406238 / 6406227	32	25	170	32,6	32		
	PCLNR/L 2525M16	6406236 / 6406225	25	25	150	28	32	CN.. 16..	36-40
	PCLNR/L 3232P16	6406239 / 6406229	32	32	170	32,6	40		
	PCLNR/L 2525M19	6406237 / 6406226	25	25	150	38	32	CN.. 19..	36-40
	PCLNR/L 3232P19	6406240 / 6406230	32	32	170	38	40		
PCLNL 3225P19	6406228	32	25	170	38	40			
PCLNR/L 4040S19	6406241 / 6406231	40	40	250	38	50			

Rechtsausführung wie gezeichnet, Linksausführung spiegelbildlich
 Righthand version as shown, lefthand version mirrorlike

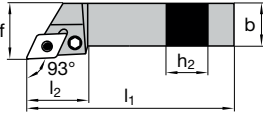

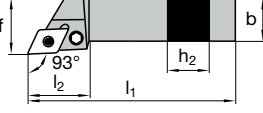

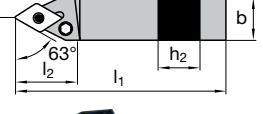
Ersatzteile Spare parts		Bestellbezeichnung Ordering Code					
							
Schneid- kantenlänge Cutting edge length	Schaftgröße Shank size	Unterlage Shim	Hebel Lever	Spann- schraube Fixation screw	Spannhülse Shim pin	Montagedorn Assembly punch	Schlüssel Key
09	1616	B01-C0931	D02-09120	A03-06170	E01-05405	V10-10000	V01-A0025
12	1616-3225	B01-C1231	D02-12130	A03-08210	E01-07205	V10-20000	V01-A0030
16	2525-3232	B01-C1547	D02-15173	A03-08235	E01-09008	V10-40000	V01-A0030
19	2525-4040	B01-C1847	D02-19210	A03-10270	E01-11011	V10-30000	V01-A0040

Bestellbeispiel: 1 Stück PCBNR 2525M12
 Order example: 1 piece PCBNR 2525M12

Lieferung ohne Schlüssel
 Delivery without key

	Bestellbezeichnung Ordering Code	Ident No.	h₁ = h₂	b	l₁	l₂	f	Passende Wende- platten Suitable inserts	Seite Page
  	PDJNR/L 1616H11	6406255 / 6406244	16	16	100	30	20	DN.. 11..	43-44
	PDJNR/L 2020K11	6406256 / 6406245	20	20	125	30	25		
	PDJNR/L 2525M11	6406259 / 6406248	25	25	150	30	32	DN.. 15..	43-46
	PDJNR/L 2020K15	6406258 / 6406247	20	20	125	34,7	25		
	PDJNR/L 2525M15	6406261 / 6406250	25	25	150	34,7	32		
	PDJNR/L 3225P15	6406263 / 6406252	32	25	170	34,7	32		
	PDJNR/L 3232P15	6406264 / 6406253	32	32	170	34,7	40		
  	PDJNR/L 2020K14	6406257 / 6406246	20	20	125	34,7	25	DN.. 14..	45
	PDJNR/L 2525M14	6406260 / 6406249	25	25	150	34,7	32	DN.. 14..	45
	PDJNR/L 3225P14	6406262 / 6406251	32	25	170	34,7	32		
	PDJNL 4025R14	6406254	40	25	200	34,7	32		
  	PDNNR/L 2525M11	6406270 / 6406266	25	25	150	30	12,5	DN.. 11..	43-44
	PDNNR/L 2525M15	6406271 / 6406267	25	25	150	36,5	12,5	DN.. 15..	42-46
	PDNNR/L 3225P15	6406272 / 6406268	32	25	170	36,5	12,5		
	PDNNR/L 4025P15	6406273 / 6406269	40	25	170	36,5	12,5		

Rechtsausführung wie gezeichnet, Linksausführung spiegelbildlich
Righthand version as shown, lefthand version mirrorlike

Ersatzteile Spare parts		Bestellbezeichnung Ordering Code					
							
Schneid- kantenlänge Cutting edge length	Schaftgröße Shank size	Unterlage Shim	Hebel Lever	Spann- schraube Fixation screw	Spannhülse Shim pin	Montagedorn Assembly punch	Schlüssel Key
11	1616-2525	B01-D1131	D02-10120	A03-06170	E01-05405	V10-10000	V01-A0025
14	2020-4025	B01-D1331	D02-15145	A03-08210	E01-07205	V10-20000	V01-A0030
15 ¹⁾	2020-4025	B01-D1448	D02-15145	A03-08210	E01-07205	V10-20000	V01-A0030
15 ²⁾	2020-4025	B01-D1447	D02-15145	A03-08210	E01-07205	V10-20000	V01-A0030
15 ³⁾	2020-4025	B01-D1432	D02-15145	A03-08210	E01-07205	V10-20000	V01-A0030
15 ⁴⁾	2020-4025	B01-D1431	D02-15145	A03-08210	E01-07205	V10-20000	V01-A0030

Für WSP DNMG 1504../ for insert DNMG 1504..

Für WSP DNMG 1506../ for insert DNMG 1506..

¹⁾ s = 4,76 mm, r = 0,4; 0,8 mm







³⁾ s = 6,35 mm, r = 0,4; 0,8 mm

²⁾ s = 4,76 mm, r = 1,2; 1,6 mm

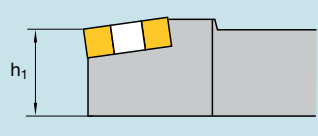

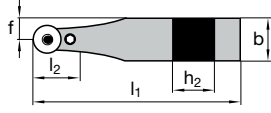

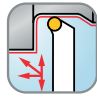
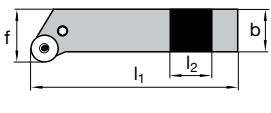

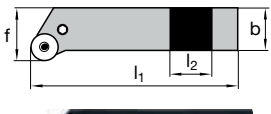
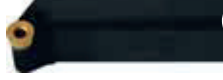
⁴⁾ s = 6,35 mm, r = 1,2; 1,6 mm

Bestellbeispiel: 1 Stück PDJNR 1616H11
Order example: 1 piece PDJNR 1616H11

Lieferung ohne Schlüssel
Delivery without key

	Bestellbezeichnung Ordering Code	Ident No.	h ₁ = h ₂	b	l ₁	l ₂	f	Passende Wende- platten Suitable inserts	Seite Page
PRDC-N   	PRDCN 2020M10	6406279	20	20	150	22	10	RCMX 10..	47
	PRDCN 2525M10	6406280	25	25	150	22	12,5	RCMX 12..	47
	PRDCN 2525M12	6406281	25	25	150	24	12,5		
	PRDCN 3225P12	6406282	32	25	170	24	12,5	RCMX 16..	47
	PRDCN 3225P16	6406283	32	25	170	28	12,5		
	PRDCN 3232P20	6406284	32	32	170	32	16	RCMX 20..	47
	PRDCN 4040S25	6406285	40	40	250	42	20	RCMX 25..	47
PRGC-R/L   	PRGCR/L 2525M12	6406292 / 6406286	25	25	150		32	RCMX 12..	47
	PRGCR/L 3225P12	6406293 / 6406287	32	25	170		32	RCMX 16..	47
	PRGCR/L 3225P16	6406294 / 6406288	32	25	170		32		
	PRGCR/L 3232P16	6406295 / 6406289	32	32	170		40	RCMX 20..	47
	PRGCR/L 3232P20	6406296 / 6406290	32	32	170		40		
	PRGCR/L 4040S25	6406297 / 6406291	40	40	250		50	RCMX 25..	47
	PRSCR-R/L   	PRSCR 2020K10	6406302	20	20	125		25	RC.. 10..
PRSCR 2020K12		6406303	20	20	125		25	RC.. 12..	47
PRSCR/L 2525M10		6406304 / 6406298	25	25	150		32	RC.. 10..	46-47
PRSCL 2525M12		6406299	25	25	150		32	RC.. 12..	47
PRSCR/L 2525M16		6406305 / 6406300	25	25	150		32	RC.. 16..	46-47
PRSCR/L 3225P12		6406306 / 6406301	32	25	170		32	RC.. 12..	47
PRSCR 3225P16		6406307	32	25	170		32	RC.. 16..	46-47
PRSCR 3232P20		6406308	32	32	170		40	RC.. 20..	46-47

Rechtsausführung wie gezeichnet, Linksausführung spiegelbildlich
Righthand version as shown, lefthand version mirrorlike

Ersatzteile Spare parts		Bestellbezeichnung Ordering Code					
							
Schneid- kantenlänge Cutting edge length	Schaftgröße Shank size	Unterlage Shim	Hebel Lever	Spann- schraube Fixation screw	Spannhülse Shim pin	Montagedorn Assembly punch	Schlüssel Key
10	2020–2525	B05-R0831	D05-10118	A03-05140	E01-05405	V10-10000	V01-A0020
12	2525–3225	B05-R0931	D05-12133	A03-06170	E01-05405	V10-10000	V01-A0025
16	2525–3225	B05-R1347	D05-17178	A03-06210	E01-07409	V10-20000	V01-A0025
20	3232	B05-R1747	D05-19189	A03-08235	E01-09008	V10-40000	V01-A0030
25	4040	B05-R2263	D05-23235	A03-10305	E01-11011	V10-30000	V01-A0040

Bestellbeispiel: 1 Stück PRDCN 2020M10
Order example: 1 piece PRDCN 2020M10

Lieferung ohne Schlüssel
Delivery without key





	Bestellbezeichnung Ordering Code		$h_1 = h_2$	b	l ₁	l ₂	f	Passende Wende- platten Suitable inserts	Seite Page
	Ident No.								
 	PSBNR/L 2020K12	6406318 / 6406310	20	20	125	27,5	17	SN.. 12..	49-52
	PSBNR/L 2525M12	6406319 / 6406311	25	25	150	27,5	22		
	PSBNR/L 3225P12	6406320 / 6406312	32	25	170	32	22	SN.. 15..	50-52
	PSBNR/L 3232P15	6406321 / 6406313	32	32	170	32	27		
	PSBNR/L 3232P19	6406322 / 6406314	32	32	170	39,2	27	SN.. 19..	49-52
	PSBNR/L 4040S19	6406323 / 6406315	40	40	250	38,5	35	SN.. 25..	49-52
	PSBNR/L 4040S25	6406324 / 6406316	40	40	250	47,5	35		
	PSBNR/L 5050T25	6406325 / 6406317	50	50	300	49	43		
 	PSDNN 1616H09	6406326	16	16	100	21	8,3	SN.. 09..	49-50
	PSDNN 2020K12	6406327	20	20	125	27,6	10,3	SN.. 12..	49-52
	PSDNN 2525M12	6406328	25	25	150	27,6	12,8	SN.. 19..	49-52
	PSDNN 3225P19	6406329	32	25	170	40,4	13		
	PSDNN 3232P19	6406330	32	32	170	40,4	12,5		
 	PSKNR/L 1616H09	6406338 / 6406331	16	16	100	18,7	20	SN.. 09..	49-50
	PSKNR/L 2020K12	6406339 / 6406332	20	20	125	22,7	25	SN.. 12..	49-52
	PSKNR/L 2525M12	6406340 / 6406333	25	25	150	22,7	32	SN.. 15..	50-52
	PSKNR/L 3225P12	6406342 / 6406335	32	25	170	32	32		
	PSKNR/L 2525M15	6406341 / 6406334	25	25	150	22,7	32	SN.. 19..	49-52
	PSKNR/L 3232P19	6406343 / 6406336	32	32	170	33,7	40		
PSKNR/L 4040S19	6406344 / 6406337	40	40	250	37,6	50			

Rechtsausführung wie gezeichnet, Linksausführung spiegelbildlich
Righthand version as shown, lefthand version mirrorlike



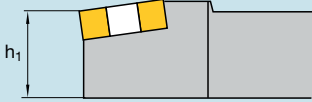

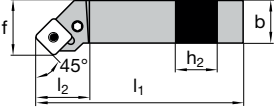

Ersatzteile Spare parts		Bestellbezeichnung Ordering Code					
Schneid- kantenlänge Cutting edge length	Schaftgröße Shank size						
		Unterlage Shim	Hebel Lever	Spann- schraube Fixation screw	Spannhülse Shim pin	Montagedorn Assembly punch	Schlüssel Key
09	1616	B01-S0931	D02-09120	A03-05095	E01-05405	V10-10000	V01-A0025
12	2020-3225	B01-S1231	D02-12130	A03-08210	E01-07205	V10-20000	V01-A0030
15	2525-3232	B01-S1547	D02-15173	A03-08235	E01-09008	V10-40000	V01-A0030
19	3232-4040	B01-S1847	D02-19210	A03-10270	E01-11011	V10-30000	V01-A0040
25	4040-5050	B01-S2463	D02-23250	A03-12360	E01-15212	V10-50000	V01-A0050

Bestellbeispiel: 1 Stück PSBNR 2020K12
Order example: 1 piece PSBNR 2020K12

Lieferung ohne Schlüssel
Delivery without key







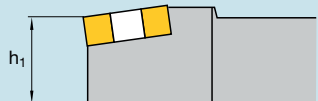

			$h_1 = h_2$	b	l ₁	l ₂	f	Passende Wende- platten Suitable inserts	Seite Page
	Bestellbezeichnung Ordering Code	Ident No.							
<p>PSSN-R/L</p>   	PSSNR/L 1616H09	6406352 / 6406345	16	16	100	21,2	20	SN.. 09..	49-50
	PSSNR/L 2020K12	6406353 / 6406346	20	20	125	29,3	25	SN.. 12..	49-52
	PSSNR/L 2525M12	6406354 / 6406347	25	25	150	29,3	32		
	PSSNR/L 3225P12	6406356 / 6406349	32	25	170	32	32		
	PSSNR/L 2525M15	6406355 / 6406348	25	25	150	29,3	32	SN.. 15..	50-52
	PSSNR/L 3232P19	6406357 / 6406350	32	32	170	40,2	40	SN.. 19..	49-52
	PSSNR/L 4040S19	6406358 / 6406351	40	40	250	39,5	50	SN.. 19..	49-52

Rechtsausführung wie gezeichnet, Linksausführung spiegelbildlich
 Righthand version as shown, lefthand version mirrorlike

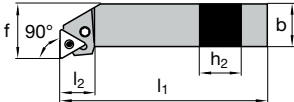

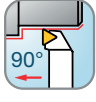
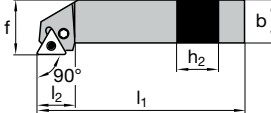

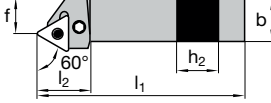

Ersatzteile Spare parts		Bestellbezeichnung Ordering Code					
Schneid- kantenlänge Cutting edge length	Schaftgröße Shank size	 Unterlage Shim	 Hebel Lever	 Spann- schraube Fixation screw	 Spannhülse Shim pin	 Montagedorn Assembly punch	 Schlüssel Key
09	1616	B01-S0931	D02-09120	A03-05096	E01-05405	V10-10000	V01-A0025
12	2020-3225	B01-S1231	D02-12130	A03-08210	E01-07205	V10-20000	V01-A0030
15	2525	B01-S1547	D02-15173	A03-08235	E01-09008	V10-40000	V01-A0030
19	3232-4040	B01-S1847	D02-19210	A03-10270	E01-11011	V10-30000	V01-A0040

Bestellbeispiel: 1 Stück PSSNR 1616H09
 Order example: 1 piece PSSNR 1616H09

Lieferung ohne Schlüssel
 Delivery without key





	Bestellbezeichnung Ordering Code	Ident No.	h₁ = h₂	b	l₁	l₂	f	Passende Wende- platten Suitable inserts	Seite Page
PTFN-R/L   	PTFNR/L 1616H16	6406364 / 6406359	16	16	100	19,7	20	TN.. 16..	53-55
	PTFNR/L 2020K16	6406365 / 6406360	20	20	125	20,2	25		
	PTFNR/L 2525M16	6406366 / 6406361	25	25	150	20,2	32		
	PTFNR/L 2525M22	6406367 / 6406362	25	25	150	25,2	32	TN.. 22..	53-55
	PTFNR/L 3225P22	6406368 / 6406363	32	25	170	25,2	32		
PTGN-R/L   	PTGNR/L 1616H16	6406376 / 6406369	16	16	100	20	20	TN.. 16..	53-55
	PTGNR/L 2020K16	6406377 / 6406370	20	20	125	20	25		
	PTGNR/L 2525M16	6406378 / 6406371	25	25	150	22,2	32		
	PTGNR/L 3225P16	6406380 / 6406373	32	25	170	22,2	32		
	PTGNR/L 2525M22	6406379 / 6406372	25	25	150	25,2	32	TN.. 22..	53-55
PTGNR/L 3232P22	6406381 / 6406374	32	32	170	28,7	40	TN.. 22..	53-55	
PTTN-R/L   	PTTNR/L 2020K16	6406417 / 6406415	20	20	125	25,9	17	TN.. 16..	53-55
	PTTNR/L 2525M22	6406418 / 6406416	25	25	150	31,9	22	TN.. 22..	53-55

Rechtsausführung wie gezeichnet, Linksausführung spiegelbildlich
 Righthand version as shown, lefthand version mirrorlike



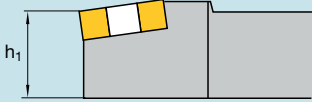

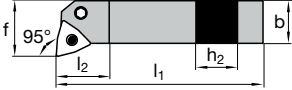

Ersatzteile Spare parts		Bestellbezeichnung Ordering Code					
Schneid- kantenlänge Cutting edge length	Schaftgröße Shank size	 Unterlage Shim	 Hebel Lever	 Spann- schraube Fixation screw	 Spannhülse Shim pin	 Montagedorn Assembly punch	 Schlüssel Key
16	1616 – 3225	B01-T1527	D02-09120	A03-06170	E01-05405	V10-10000	V01-A0025
22	2525 – 3232	B01-T2031	D02-12130	A03-08210	E01-07205	V10-20000	V01-A0030

Bestellbeispiel: 1 Stück PTFNR 1616H16
 Order example: 1 piece PTFNR 1616H16

Lieferung ohne Schlüssel
 Delivery without key







			$h_1 = h_2$	b	l ₁	l ₂	f	Passende Wendeplatten Suitable inserts	Seite Page
	Bestellbezeichnung Ordering Code	Ident No.							
PWLN-R/L   	PWLN-R/L 1616H06	6406425 / 6406419	16	16	100	20	20	WN.. 06..	58-60
	PWLN-R/L 2020K06	6406426 / 6406420	20	20	125	25	25		
	PWLN-R/L 2525M06	6406428 / 6406422	25	25	150	25	32		
	PWLN-R/L 2020K08	6406427 / 6406421	20	20	125	25	25	WN.. 08..	58-61
	PWLN-R/L 2525M08	6406429 / 6406423	25	25	150	25	32		

Rechtsausführung wie gezeichnet, Linksausführung spiegelbildlich
 Righthand version as shown, lefthand version mirrorlike

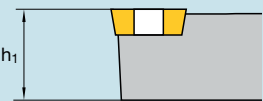
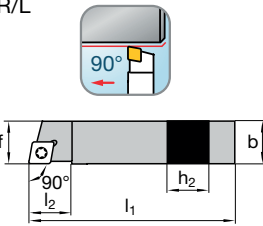

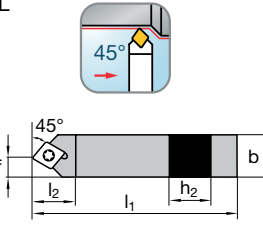
Ersatzteile Spare parts		Bestellbezeichnung Ordering Code					
Schneidkantenlänge Cutting edge length	Schaftgröße Shank size	 Unterlage Shim	 Hebel Lever	 Spannschraube Fixation screw	 Spannhülse Shim pin	 Montagedorn Assembly punch	 Schlüssel Key
06	1616–2525	B01-W0627	D02-09120	A03-06170	E01-05807	V10-10000	V01-A0025
08	2020–3225	B01-W0831	D02-12130	A03-08210	E01-07205	V10-20000	V01-A0030

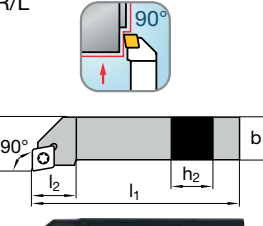
Bestellbeispiel: 1 Stück PWLNR 1616H06
 Order example: 1 piece PWLNR 1616H06

Lieferung ohne Schlüssel
 Delivery without key

	Bestellbezeichnung Ordering Code		h ₁ = h ₂	b	l ₁	l ₂	f	Passende Wende- platten Suitable inserts	Seite Page
	Ident No.								
 	SCACR/L 0808D06	6406571 / 6406562	8	8	60	9	8	CC.. 06..	34-35
	SCACR/L 0808K06	6406572 / 6406563	8	8	125	9	8		
	SCACR/L 1010E06	6406573 / 6406564	10	10	70	9	10		
	SCACR/L 1010M06	6406574 / 6406565	10	10	150	9	10		
	SCACR/L 1212F09	6406575 / 6406566	12	12	80	13	12	CC.. 09..	34-35
	SCACR/L 1212M09	6406576 / 6406567	12	12	150	13	12		
	SCACR/L 1414M09	6406577 / 6406568	14	14	150	13	14		
	SCACR/L 1616H09	6406578 / 6406569	16	16	100	13	16		
	SCACR/L 2020K12	6406579 / 6406570	20	20	125	17	20	CC.. 12..	34-35
	 	SCDCL 0808K06	6406580	8	8	125	13	4	CC.. 06..
SCDCL 1010M06		6406581	10	10	150	13	5		
SCDCL 1212M09		6406582	12	12	150	18	6	CC.. 09..	34-35
SCDCL 1414M09		6406583	14	14	150	18	7		
 		SCFCR/L 0808D06	6406589 / 6406584	8	8	60	10	8	CC.. 06..
	SCFCR/L 1010E06	6406590 / 6406585	10	10	70	10	10		
	SCFCR/L 1212F09	6406591 / 6406586	12	12	80	13	12	CC.. 09..	34-35
	SCFCR/L 1616H09	6406592 / 6406587	16	16	100	13	16		
	SCFCR/L 2020K12	6406593 / 6406588	20	20	125	17	20	CC.. 12..	34-35

Rechtsausführung wie gezeichnet, Linksausführung spiegelbildlich
 Righthand version as shown, lefthand version mirrorlike

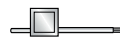
Ersatzteile Spare parts		Bestellbezeichnung Ordering Code			
Schneid- kantenlänge Cutting edge length	Schaftgröße Shank size	 Unterlage Shim	 Gewindehülse Shim screw	 Klemm- schraube Fixation screw	 Schlüssel Key
06	0808 – 1010	–	–	A02-25059	V02-T0800
09	1212 – 1414	–	–	A02-35082	V02-T1500
09	1616 – 2020	B09-C0923	E09-F5035	A02-35096	V05-T1534
12	1616 – 2020	B09-C1231	E09-F6045	A02-45102	V05-T1534

Bestellbeispiel: 1 Stück SCACR 0808D06
 Order example: 1 piece SCACR 0808D06

Lieferung ohne Schlüssel
 Delivery without key





	Bestellbezeichnung Ordering Code	Ident No.	h₁ = h₂	b	l₁	l₂	f	Passende Wende- platten Suitable inserts	Seite Page
<p>SCGC-R/L</p>	SCGCR/L 2020K12	6406595 / 6406594	20	20	125	17	25	CC.. 12..	34-35
<p>SCLC-R/L</p>	SCLCR/L 0808D06 SCLCR 1010E06 SCLCR/L 1212F09 SCLCR/L 1616H09 SCLCR/L 2020K09 SCLCR/L 1616H12 SCLCR/L 2020K12 SCLCR/L 2525M12 SCLCR/L 3225P12	6406614 / 6406605 6406615 6406616 / 6406607 6406617 / 6406608 6406619 / 6406610 6406618 / 6406609 6406620 / 6406611 6406621 / 6406612 6406622 / 6406613	8 10 12 16 20 16 20 25 32	8 10 12 16 20 16 20 25 25	60 70 80 100 125 100 125 150 170	9 9 15 17 17 20 20 20 20 25 32 32	8 12 16 20 25 32	CC.. 06.. CC.. 09.. CC.. 12..	34-35 34-35 34-35
<p>SCMC-N</p>	SCMCN 1616H12 SCMCN 2020K12 SCMCN 2525M12 SCMCN 3225P12	6406623 6406624 6406625 6406626	16 20 25 32	16 20 25 25	100 125 150 170	25 25 25 25	8 10 12,5 12,5	CC.. 12..	34-35

Rechtsausführung wie gezeichnet, Linksausführung spiegelbildlich
 Righthand version as shown, lefthand version mirrorlike

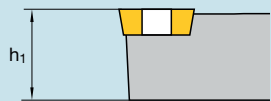
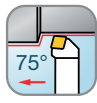
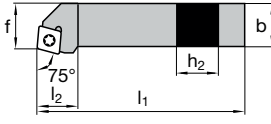

Ersatzteile Spare parts		Bestellbezeichnung Ordering Code				
Schneid- kantenlänge Cutting edge length	Schaftgröße Shank size	Unterlage Shim	Gewindehülse Shim screw	Klemm- schraube Fixation screw	Schlüssel Key	
06	0808-1010	-	-	A02-25059	V02-T0800	
09	1212	-	-	A02-35082	V02-T1500	
09	1616-2020	B09-C0923	E09-F5035	A02-35096	V05-T1534	
12	1616-3225	B09-C1231	E09-F6045	A02-45102	V05-T1534	

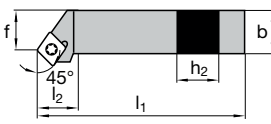
Bestellbeispiel: 1 Stück SCGCR 2020K12
 Order example: 1 piece SCGCR 2020K12

Lieferung ohne Schlüssel
 Delivery without key









	Bestellbezeichnung Ordering Code		h ₁ = h ₂	b	l ₁	l ₂	f	Passende Wende- platten Suitable inserts	Seite Page	
	Ident No.									
<p>SCRCR-R/L</p>   	SCRCR/L 0808D06	6406647 / 6406638	8	8	60	10	9	CC.. 06..	34-35	
	SCRCR/L 1010E06	6406648 / 6406639	10	10	70	10	11			
	SCRCR/L 1212F09	6406649 / 6406640	12	12	80	16	13			
		SCRCR/L 1616H09	6406650 / 6406641	16	16	100	17	17	CC.. 12..	34-35
		SCRCR/L 2020K09	6406652 / 6406643	20	20	125	17	22		
		SCRCR/L 1616H12	6406651 / 6406642	16	16	100	20	17		
		SCRCR/L 2020K12	6406653 / 6406644	20	20	125	20	22		
		SCRCR/L 2525M12	6406654 / 6406645	25	25	150	20	27		
		SCRCR/L 3225P12	6406655 / 6406646	32	25	170	20	27		
<p>SCSCR-R/L</p>   	SCSCR/L 1616H12	6406660 / 6406656	16	16	100	20	20	CC.. 12..	34-35	
	SCSCR/L 2020K12	6406661 / 6406657	20	20	125	20	25			
	SCSCR/L 2525M12	6406662 / 6406658	25	25	150	20	32			
	SCSCR/L 3225P12	6406663 / 6406659	32	25	170	20	32			

Rechtsausführung wie gezeichnet, Linksausführung spiegelbildlich
 Righthand version as shown, lefthand version mirrorlike

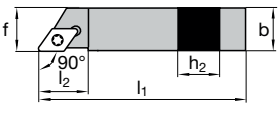

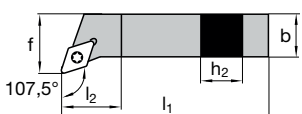

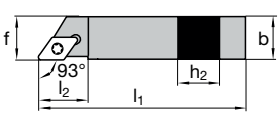
Ersatzteile Spare parts		Bestellbezeichnung Ordering Code					
Schneid- kantenlänge Cutting edge length	Schaftgröße Shank size	 Unterlage Shim	 Gewindehülse Shim screw	 Klemm- schraube Fixation screw	 Schlüssel Key		
06	0808-1010	-	-	A02-25059	V02-T0800		
09	1212	-	-	A02-35082	V02-T1500		
09	1616-2020	B09-C0923	E09-F5035	A02-35096	V05-T1534		
12	1616-3225	B09-C1231	E09-F6045	A02-45102	V05-T1534		

Bestellbeispiel: 1 Stück SCRCR 0808D06
 Order example: 1 piece SCRCR 0808D06

Lieferung ohne Schlüssel
 Delivery without key



	Bestellbezeichnung Ordering Code	Ident No.	h₁ = h₂	b	l₁	l₂	f	Passende Wende- platten Suitable inserts	Seite Page
SDACR-R/L   	SDACR/L 0808K07	6406673 / 6406668	8	8	125	14	8	DC.. 07..	40-42
	SDACR/L 1010M07	6406674 / 6406669	10	10	150	14	10		
	SDACR/L 1212M07	6406675 / 6406670	12	12	150	14	12		
	SDACR/L 1212M11	6406676 / 6406671	12	12	150	21	12	DC.. 11..	40-42
	SDACR/L 1414M11	6406677 / 6406672	14	14	150	21	14		
	SDACR/L 1010X07-D	6424956 / 6424954	10	10	150	15	10	DC.. 07..	40-42
	SDACR/L 1212X07-D	6424957 / 6424955	12	12	150	15	12		
SDHCR-R/L   	SDHCR/L 1010E07	6406683 / 6406678	10	10	70	5,5	12	DC.. 07..	40-42
	SDHCR/L 1212F07	6406684 / 6406679	12	12	80	12	16		
	SDHCR/L 1616H11	6406685 / 6406680	16	16	100	10,4	20	DC.. 11..	40-42
	SDHCR/L 2020K11	6406686 / 6406681	20	20	125	14	25		
	SDHCR/L 2525M11	6406687 / 6406682	25	25	150	20	32		
SDJCR-R/L   	SDJCR/L 0808D07	6406717 / 6406708	8	8	60	13	10	DC.. 07..	40-42
	SDJCR/L 1010E07	6406718 / 6406709	10	10	70	13	12		
	SDJCR/L 1212F07	6406719 / 6406710	12	12	80	14,5	16	DC.. 11..	40-42
	SDJCR/L 1212F11	6406720 / 6406711	12	12	80	22	16		
	SDJCR/L 1616H11	6406721 / 6406712	16	16	100	20	20	DC.. 15..	42
	SDJCR/L 2020K11	6406722 / 6406713	20	20	125	20,5	25		
	SDJCR/L 2525M11	6406723 / 6406714	25	25	150	21,5	32	DC.. 07..	40-42
	SDJCR/L 3225P11	6406725 / 6406716	32	25	150	21,25	32		
	SDJCR/L 2525M15	6406724 / 6406715	25	25	150	26	32	DC.. 11..	40-42
	SDJCR/L 1010X07-D	6424962 / 6424958	10	10	115	15	10		
	SDJCR/L 1212X07-D	6424963 / 6424959	12	12	130	15	12	DC.. 11..	40-42
	SDJCR/L 1212X11-D	6424964 / 6424960	12	12	130	15	12		
	SDJCR/L 1616X11-D	6424965 / 6424961	16	16	130	20	16		



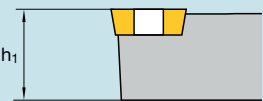
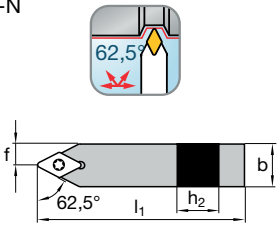

Rechtsausführung wie gezeichnet, Linksausführung spiegelbildlich
 Righthand version as shown, lefthand version mirrorlike

Ersatzteile Spare parts		Bestellbezeichnung Ordering Code					
Schneid- kantenlänge Cutting edge length	Schaftgröße Shank size						
		Unterlage Shim	Gewindehülse Shim screw	Klemm- schraube Fixation screw	Schlüssel Key		
		07	0808-1212	-	-	A02-25059	V02-T0800
		11	1212-1414	-	-	A02-35082	V02-T1500
		11	1616-3225	B09-D1131	E09-F5035	A02-35096	V05-T1534
15	2525	B02-D1431	E02-60045	A02-45102	V05-T1534		

Bestellbeispiel: 1 Stück SDACR 0808K07
 Order example: 1 piece SDACR 0808K07





Lieferung ohne Schlüssel
 Delivery without key

		Bestellbezeichnung Ordering Code	Ident No.	$h_1 = h_2$	b	l_1	l_2	f	Passende Wende- platten Suitable inserts	Seite Page	
<p>SDNC-N</p>  		SDNCN 0808D07	6406734	8	8	60		4	DC.. 07..	40-42	
	SDNCN 0808K07	6406735	8	8	125		4				
	SDNCN 1010E07	6406736	10	10	70		5				
	SDNCN 1010M07	6406737	10	10	150		5				
	SDNCN 1212F07	6406738	12	12	80		6				
	SDNCN 1212M07	6406740	12	12	150		6				
			SDNCN 1212F11	6406739	12	12	80		6	DC.. 11..	40-42
			SDNCN 1212M11	6406741	12	12	150		6		
			SDNCN 1414M11	6406742	14	14	150		7		
			SDNCN 1616H11	6406743	16	16	100		8		
			SDNCN 2020K11	6406744	20	20	125		10		
			SDNCN 2525M11	6406745	25	25	150		12,5		

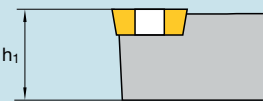
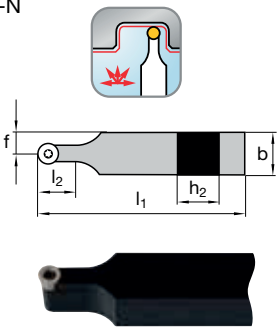

Ersatzteile Spare parts		Bestellbezeichnung Ordering Code					
Schneid- kantenlänge Cutting edge length	Schaftgröße Shank size	 Unterlage Shim	 Gewindehülse Shim screw	 Klemm- schraube Fixation screw	 Schlüssel Key		
07	0808 – 1212	-	-	A02-25059	V02-T0800		
11	1212 – 1414	-	-	A02-35082	V02-T1500		
11	1616 – 2525	B09-D1131	E09-F5035	A02-35096	V05-T1534		

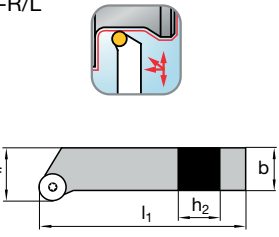
Bestellbeispiel: 1 Stück SDNCN 0808D07
 Order example: 1 piece SDNCN 0808D07

Lieferung ohne Schlüssel
 Delivery without key

		Bestellbezeichnung Ordering Code	Ident No.	$h_1 = h_2$	b	l_1	l_2	f	Passende Wende- platten Suitable inserts	Seite Page
SRDC-N  		SRDCN 1212F06	6406989	12	12	80	12,4	6	RCGT 06..	46
		SRDCN 1616H06	6406990	16	16	100	12,4	8	RCMT 06..	46
		SRDCN 2020K06	6406994	20	20	125	12,4	10		
		SRDCN 2525M06	6406997	25	25	150	12,4	12,5		
		SRDCN 1616H08	6406991	16	16	100	16,4	8	RCGT 08..	46
		SRDCN 2020K08	6406995	20	20	125	16,4	10		
		SRDCN 2525M08	6406998	25	25	150	16,4	12,5		
		SRDCN 1616H10	6406992	16	16	100	20,3	8	RCGT 10..	46
		SRDCN 2020K10	6406996	20	20	125	20,3	10		
		SRDCN 2525M10	6406999	25	25	150	20,3	12,5		
SRGC-R/L  		SRGCR/L 1212F06	6407010 / 6407000	12	12	80	10	16	RCGT 06..	46
		SRGCR/L 1616H06	6407011 / 6407001	16	16	100	10	20	RCMT 06..	46
		SRGCR/L 2020K06	6407014 / 6407004	20	20	125	11,5	25		
		SRGCR/L 2525M06	6407017 / 6407007	25	25	150	15	32		
		SRGCR/L 1616H08	6407012 / 6407002	16	16	100	11	20	RCGT 08..	46
		SRGCR/L 2020K08	6407015 / 6407005	20	20	125	12	25		
		SRGCR/L 2525M08	6407018 / 6407008	25	25	150	16,4	32		
		SRGCR/L 1616H10	6407013 / 6407003	16	16	100	12	20	RCGT 10..	46
		SRGCR/L 2020K10	6407016 / 6407006	20	20	125	13,5	25		
		SRGCR/L 2525M10	6407019 / 6407009	25	25	150	17	32		

Rechtsausführung wie gezeichnet, Linksausführung spiegelbildlich
 Righthand version as shown, lefthand version mirrorlike

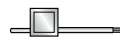
Ersatzteile Spare parts		Bestellbezeichnung Ordering Code				
Schneid- kantenlänge Cutting edge length	Schaftgröße Shank size	 Unterlage Shim	 Gewindehülse Shim screw	 Klemm- schraube Fixation screw	 Schlüssel Key	
06	1212-2525	-	-	A02-25059	V02-T0800	
08	1616-2525	-	-	A13-30073	V02-T1500	
10	1616-2525	B09-R1025	E09-F5035	A13-35110	V05-T1534	

Bestellbeispiel: 1 Stück SRDCN 1212F06
 Order example: 1 piece SRDCN 1212F06

Lieferung ohne Schlüssel
 Delivery without key

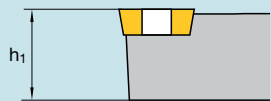
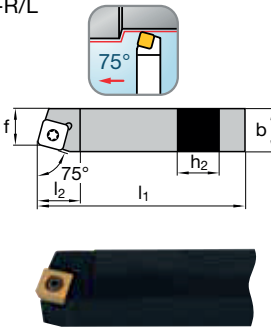
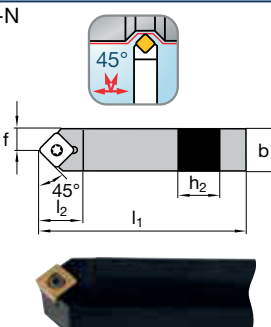
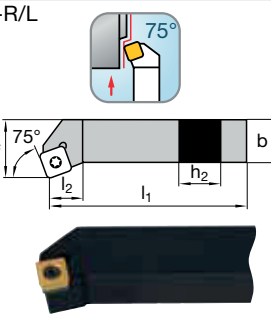



	Bestellbezeichnung Ordering Code		h ₁ = h ₂	b	l ₁	l ₂	f	Passende Wende- platten Suitable inserts	Seite Page
	Ident No.								
SSBC-R/L 	SSBCR/L 1616H09	6407024 / 6407020	16	16	100	20	13	SC.. 09..	47-49
	SSBCR/L 2020K09	6407025 / 6407021	20	20	125	20	17		
	SSBCR/L 2020K12	6407026 / 6407022	20	20	125	20	17	SC.. 12..	47-49
	SSBCR/L 2525M12	6407027 / 6407023	25	25	150	20	22		
SSDC-N 	SSDCN 1212F09	6407028	12	12	80	16	6	SC.. 09..	47-49
	SSDCN 1616H09	6407029	16	16	100	20	8		
	SSDCN 2020K09	6407030	20	20	125	20	10	SC.. 12..	47-49
	SSDCN 1616H12	6407031	16	16	100	25	8		
	SSDCN 2020K12	6407032	20	20	125	25	10	SC.. 12..	47-49
	SSDCN 2525M12	6407033	25	25	150	25	12,5		
SSKC-R/L 	SSKCR/L 1616H09	6407039 / 6407034	16	16	100	22	20	SC.. 09..	47-49
	SSKCR/L 2020K09	6407041 / 6407036	20	20	125	22	25		
	SSKCR/L 1616H12	6407040 / 6407035	16	16	100	23	20	SC.. 12..	47-49
	SSKCR/L 2020K12	6407042 / 6407037	20	20	125	23	25		
	SSKCR/L 2525M12	6407043 / 6407038	25	25	150	23	32		

Rechtsausführung wie gezeichnet, Linksausführung spiegelbildlich
 Righthand version as shown, lefthand version mirrorlike

Ersatzteile Spare parts		Bestellbezeichnung Ordering Code			
					
Schneid- kantenlänge Cutting edge length	Schaftgröße Shank size	Unterlage Shim	Gewindehülse Shim screw	Klemm- schraube Fixation screw	Schlüssel Key
09	1212	-	-	A02-35082	V02-T1500
09	1616-2020	B09-S0923	E09-F5035	A02-35096	V05-T1534
12	1616-2525	B09-S1231	E09-F6045	A02-45102	V05-T1534

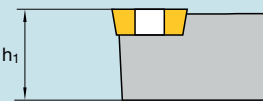
Bestellbeispiel: 1 Stück SSBCR 1616H09
 Order example: 1 piece SSBCR 1616H09

Lieferung ohne Schlüssel
 Delivery without key

			$h_1 = h_2$	b	l ₁	l ₂	f	Passende Wende- platten Suitable inserts	Seite Page	
	Bestellbezeichnung Ordering Code	Ident No.								
SSSC-R/L   	SSSCR/L 1212F09	6407051 / 6407044	12	12	80	18	16	SC.. 09..	47-49	
	SSSCR/L 1616H09	6407052 / 6407045	16	16	100	20	20			
	SSSCR/L 2020K09	6407054 / 6407047	20	20	125	20	25			
		SSSCR/L 1616H12	6407053 / 6407046	16	16	100	25	20	SC.. 12..	47-49
		SSSCR/L 2020K12	6407055 / 6407048	20	20	125	25	25		
		SSSCR/L 2525M12	6407056 / 6407049	25	25	150	25	32		
		SSSCR/L 3225P12	6407057 / 6407050	32	25	170	25	32		

Rechtsausführung wie gezeichnet, Linksausführung spiegelbildlich
 Righthand version as shown, lefthand version mirrorlike

Ersatzteile Spare parts		Bestellbezeichnung Ordering Code				
Schneid- kantenlänge Cutting edge length	Schaftgröße Shank size	 Unterlage Shim	 Gewindehülse Shim screw	 Klemm- schraube Fixation screw	 Schlüssel Key	
09	1212	-	-	A02-35082	V02-T1500	
09	1616-2020	B09-S0923	E09-F5035	A02-35096	V05-T1534	
12	1616-3225	B09-S1231	E09-F6045	A02-45102	V05-T1534	

Bestellbeispiel: 1 Stück SSSCR 1212F09
 Order example: 1 piece SSSCR 1212F09

Lieferung ohne Schlüssel
 Delivery without key





		Bestellbezeichnung Ordering Code	Ident No.	$h_1 = h_2$	b	l_1	l_2	f	Passende Wende- platten Suitable inserts	Seite Page
STACR-R/L 		STACR/L 1212K11	6407061 / 6407058	12	12	125	15	12	TC.. 11..	52-53
		STACR/L 1414K11	6407062 / 6407059	14	14	125	15	14		
		STACR/L 1616K11	6407063 / 6407060	16	16	125	15	16		
STCC-N 		STCCN 1010K11	6407074	10	10	125	15	-	TC.. 11..	52-53
		STCCN 1212K11	6407075	12	12	125	15	-		
		STCCN 1414K11	6407076	14	14	125	21	-		
		STCCN 1616K11	6407077	16	16	125	24	-		
STFCR-R/L 		STFCR/L 1212F11	6407104 / 6407100	12	12	80	15	16	TC.. 11..	52-53
		STFCR/L 1616H16	6407105 / 6407101	16	16	100	20	20	TC.. 16..	52-53
		STFCR/L 2020K16	6407106 / 6407102	20	20	125	20	25		
		STFCR/L 2525M16	6407107 / 6407103	25	25	150	20	32		

Rechtsausführung wie gezeichnet, Linksausführung spiegelbildlich
 Righthand version as shown, lefthand version mirrorlike

Ersatzteile Spare parts		Bestellbezeichnung Ordering Code					
Schneid- kantenlänge Cutting edge length	Schaftgröße Shank size	Unterlage Shim	Gewindehülse Shim screw	Klemm- schraube Fixation screw	Schlüssel Key		
11	1010-1616	-	-	A02-25059	V02-T0800		
16	1616-2525	B09-T1631	E09-F5035	A02-35096	V05-T1534		

Bestellbeispiel: 1 Stück STACR 1212K11
 Order example: 1 piece STACR 1212 K11

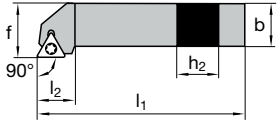
Lieferung ohne Schlüssel
 Delivery without key

			$h_1 = h_2$	b	l ₁	l ₂	f	Passende Wendeplatten Suitable inserts	Seite Page
	Bestellbezeichnung Ordering Code	Ident No.							
STGC-R/L   	STGCR/L 1212F11	6407112 / 6407108	12	12	80	15	16	TC.. 11..	52-53
	STGCR/L 1616H16	6407113 / 6407109	16	16	100	22	20	TC.. 16..	52-53
	STGCR/L 2020K16	6407114 / 6407110	20	20	125	22	25		
	STGCR/L 2525M16	6407115 / 6407111	25	25	150	22	32		

Rechtsausführung wie gezeichnet, Linksausführung spiegelbildlich
 Righthand version as shown, lefthand version mirrorlike

Ersatzteile Spare parts		Bestellbezeichnung Ordering Code					
Schneidkantenlänge Cutting edge length	Schaftgröße Shank size	 Unterlage Shim	 Gewindehülse Shim screw	 Klemmschraube Fixation screw	 Schlüssel Key		
11	1212	-	-	A02-25059	V02-T0800		
16	1616-2525	B09-T1631	E09-F5035	A02-35096	V05-T1534		

Bestellbeispiel: 1 Stück STGCR 1212F11
 Order example: 1 piece STGCR 1212 F11

Lieferung ohne Schlüssel
 Delivery without key

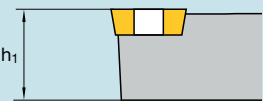
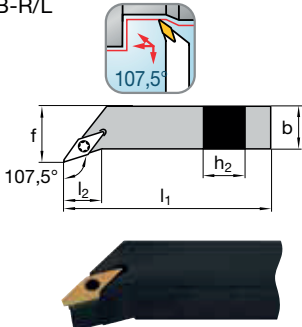
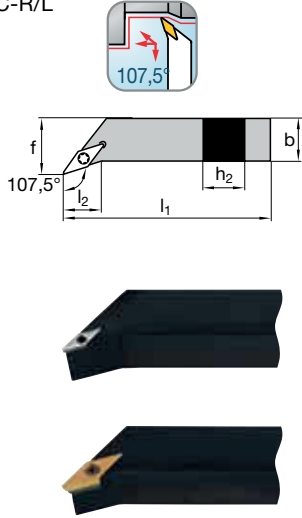





		Bestellbezeichnung		h ₁ = h ₂	b	l ₁	l ₂	f	Passende Wende- platten Suitable inserts	Seite Page
		Ordering Code	Ident No.							
SVHB-R/L		SVHBR/L 2020K16	6407118 / 6407116	20	20	125	17	25	VB.. 16..	56
		SVHBR/L 2525M16	6407119 / 6407117	25	25	150	26	32		
SVHC-R/L		SVHCR/L 1212F11	6407130 / 6407120	12	12	80	11,4	16	VC.. 11..	56-57
		SVHCR/L 1616H11	6407131 / 6407121	16	16	100	11,4	20		
		SVHCR/L 2020K11	6407132 / 6407122	20	20	125	14,6	25		
		SVHCR/L 2525M11	6407135 / 6407125	25	25	150	20,9	32	VC.. 16..	56-57
		SVHCR/L 2020K16	6407133 / 6407123	20	20	125	13,2	25		
		SVHCR/L 2525M16	6407136 / 6407126	25	25	150	19,6	32		
		SVHCR/L 3225P16	6407138 / 6407128	32	25	170	19,6	32	VC.. 22..	56-57
		SVHCR/L 2020K22	6407134 / 6407124	20	20	125	13,2	25		
		SVHCR/L 2525M22	6407137 / 6407127	25	25	150	19,6	32		
SVHCR/L 3225P22	6407139 / 6407129	32	25	170	19,6	32				

Rechtsausführung wie gezeichnet, Linksausführung spiegelbildlich
 Righthand version as shown, lefthand version mirrorlike

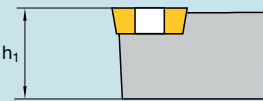

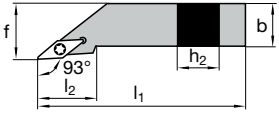

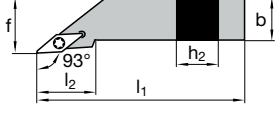
Ersatzteile Spare parts			Bestellbezeichnung Ordering Code			
Schneid- kantenlänge Cutting edge length	Wendeplatte Indexable insert	Schaftgröße Shank size	 Unterlage Shim	 Gewindehülse Shim screw	 Klemm- schraube Fixation screw	 Schlüssel Key
11	VC...	1212-2525	-	-	A02-25059	V02-T0800
16	VC...	2020-3225	B09-V1602	E09-F5035	A02-35096	V05-T1534
r = 0,4-0,8	VB...	2020-2525	B02-V1431	E02-F5035	A02-35096	V05-T1534
16	VC...	2020-3225	B09-V1606	E09-F5035	A02-35096	V05-T1534
r = 1,2	VB...	2020-2525	B02-V1431	E02-F5035	A02-35096	V05-T1534
22	VC...	2020-3225	B09-V2222	E09-F6045	A02-45102	V05-T1534

Bestellbeispiel: 1 Stück SVHBR 2020K16
 Order example: 1 piece SVHBR 2020K16

Lieferung ohne Schlüssel
 Delivery without key

									Passende Wende- platten Suitable inserts	Seite Page
		Bestellbezeichnung Ordering Code	Ident No.	h₁ = h₂	b	l₁	l₂	f		
SVJB-R/L   	SVJBR/L 2020K16	6407143 / 6407140	20	20	125	34	25	VB.. 16..	56	
	SVJBR/L 2525M16	6407144 / 6407141	25	25	150	34	32			
	SVJBR/L 3225P16	6407145 / 6407142	32	25	170	34	32			
SVJC-R/L   	SVJCR/L 1212F11	6407153 / 6407146	12	12	80	21,5	16	VC.. 11..	56-57	
	SVJCR/L 1616H11	6407154 / 6407147	16	16	100	21,5	20			
	SVJCR/L 2020K11	6407155 / 6407148	20	20	125	23	25			
	SVJCR/L 2525M11	6407157 / 6407150	25	25	150	25,5	32	VC.. 16..	56-57	
	SVJCR/L 2020K16	6407156 / 6407149	20	20	125	29,5	25			
	SVJCR/L 2525M16	6407158 / 6407151	25	25	150	32,5	32			
	SVJCR/L 3225P16	6407159 / 6407152	32	25	170	32,5	32	VC.. 11..	56-57	
	SVJCR/L 1010X11-D	6424969 / 6424966	10	10	115	21,5	10			
	SVJCR/L 1212X11-D	6424970 / 6424967	12	12	130	21,5	12			
SVJCR/L 1616X11-D	6424971 / 6424968	16	16	130	21,5	16				

Rechtsausführung wie gezeichnet, Linksausführung spiegelbildlich
 Righthand version as shown, lefthand version mirrorlike

Ersatzteile Spare parts			Bestellbezeichnung Ordering Code					
Schneid- kantenlänge Cutting edge length	Wendeplatte Indexable insert	Schaftgröße Shank size	 Unterlage Shim	 Gewindehülse Shim screw	 Klemm- schraube Fixation screw	 Schlüssel Key		
11	VC...	1212-2525	-	-	A02-25059	V02-T0800		
16	VC...	2020-3225	B09-V1602	E09-F5035	A02-35096	V05-T1534		
r = 0,4-0,8	VB...	2020-3225	B02-V1431	E02-F5035	A02-35096	V05-T1534		
16	VC...	2020-3225	B09-V1606	E09-F5035	A02-35096	V05-T1534		
r = 1,2	VB...	2020-3225	B02-V1431	E02-F5035	A02-35096	V05-T1534		
18	VO...	2020-3225	B02-V1431	E02-F5035	A02-35135	V05-T1534		

Bestellbeispiel: 1 Stück SVJBR 2020K16
 Order example: 1 piece SVJBR 2020K16

Lieferung ohne Schlüssel
 Delivery without key

		Bestellbezeichnung Ordering Code	Ident No.	$h_1 = h_2$	b	l_1	l_2	f	Passende Wende- platten Suitable inserts	Seite Page
SVVB-N 		SVVBN 2020K16	6407166	20	20	125	32	10	VB.. 16..	56
		SVVBN 2525M16	6407167	25	25	150	40	12,5		
		SVVBN 3225P16	6407168	32	25	170	40	12,5		
SVCN-N SVVO-N 		SVVCN 1212F11	6407169	12	12	80	19	6	VC.. 11..	56-57
		SVVCN 1616H11	6407170	16	16	100	25	8		
		SVVCN 2020K11	6407171	20	20	125	32	10		
		SVVCN 2525M11	6407173	25	25	150	40	12,5	VC.. 16..04 VC.. 16..08 VC.. 16..12	56-57
		SVVCN 2020K16	6407172	20	20	125	32	10		
		SVVCN 2525M16	6407174	25	25	150	40	12,5		
	SVVCN 3225P16	6407175	32	25	170	40	12,5			
SVZC-R/L 		SVZCR/L 2525M16	6407180 / 6407179	25	25	150	28,5	32	VC.. 16..04 VC.. 16..08 VC.. 16..12	56-57

Rechtsausführung wie gezeichnet, Linksausführung spiegelbildlich
 Righthand version as shown, lefthand version mirrorlike

Ersatzteile Spare parts			Bestellbezeichnung Ordering Code			
Schneid- kantenlänge Cutting edge length	Wendeplatte Indexable insert	Schaftgröße Shank size	Unterlage Shim	Gewindehülse Shim screw	Klemm- schraube Fixation screw	Schlüssel Key
11	VC...	1212-2525	-	-	A02-25059	V02-T0800
16	VC...	2020-3225	B09-V1602	E09-F5035	A02-35096	V05-T1534
r = 0,4-0,8	VB...	2020-3225	B02-V1431	E02-F5035	A02-35096	V05-T1534
16	VC...	2020-3225	B09-V1606	E09-F5035	A02-35096	V05-T1534
r = 1,2	VB...	2020-3225	B02-V1431	E02-F5035	A02-35096	V05-T1534
18	VO...	2020-3225	B02-V1431	E02-F5035	A02-35135	V05-T1534

Bestellbeispiel: 1 Stück SVVBN 2020K16
 Order example: 1 piece SVVBN 2020K16

Lieferung ohne Schlüssel
 Delivery without key

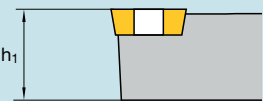
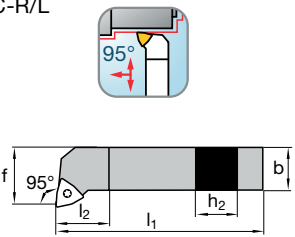
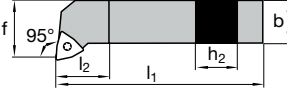

			$h_1 = h_2$	b	l ₁	l ₂	f	Passende Wendeplatten Suitable inserts	Seite Page
	Bestellbezeichnung Ordering Code	Ident No.							
SWLCR-R/L  	SWLCR/L 1212F06	6407187 / 6407181	12	12	80	14	16	WC.. 06..	58
	SWLCR/L 1616H06	6407188 / 6407182	16	16	100	16	20		
	SWLCR/L 2020K06	6407190 / 6407184	20	20	125	16	25		
	SWLCR/L 1616H08	6407189 / 6407183	16	16	100	17	20	WC.. 08..	58
	SWLCR/L 2020K08	6407191 / 6407185	20	20	125	18	25		
	SWLCR/L 2525M08	6407192 / 6407186	25	25	150	21	32		

Rechtsausführung wie gezeichnet, Linksausführung spiegelbildlich
 Righthand version as shown, lefthand version mirrorlike

Ersatzteile Spare parts		Bestellbezeichnung Ordering Code				
Schneidkantenlänge Cutting edge length	Schaftgröße Shank size	 Unterlage Shim	 Gewindehülse Shim screw	 Klemmschraube Fixation screw	 Schlüssel Key	
06	1212	–	–	A02-35082	V02-T1500	
06	1616–2020	B09-W0623	E09-F5035	A02-35082	V05-T1534	
08	1616–2525	B09-W0831	E09-F6045	A02-45102	V05-T1534	

Bestellbeispiel: 1 Stück SWLCR 1212F06
 Order example: 1 piece SWLCR 1212F06

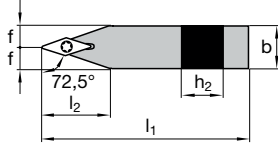
Lieferung ohne Schlüssel
 Delivery without key

	Bestellbezeichnung Ordering Code	Ident No.	h ₁	b	l ₁	Passende Wende- platten Suitable inserts	Seite Page
BM51576   	BM51576	5010414	20	20	130	XCGT26	61
						XCGT28	61

Ersatzteile Spare parts	Bestellbezeichnung Ordering Code					
	 Unterlage Shim	 Gewindehülse Shim screw	 Klemm- schraube Fixation screw	 Schlüssel Key		
	-	-	A02-35096	V04-T1500		
	-	-	A02-35096	-		

Bestellbeispiel: 1 Stück BM51576
 Order example: 1 piece BM51576

Lieferung ohne Schlüssel
 Delivery without key

	Bestellbezeichnung Ordering Code	Ident No.	d	h ₁	l ₁	l ₂	f	D _{min}	Passende Wende- platten Suitable inserts	Seite Page
	A25R-PCLNR/L 12	6401488 / 6401487	25	24	200	21	17	31,5	CN.. 12..	36-39
	S25T-PCLNR/L 12	6407249 / 6407248	25	23	300	22	17	32		
	A32S-PCLNR/L 12	6401557 / 6401556	32	31	250	24,1	22	40		
	S32U-PCLNR/L 12	6407282 / 6407281	32	30	350	24,1	22	40		
	A40T-PCLNR/L 12	6401598 / 6401597	40	39	300	24,1	27	49		
	S40V-PCLNR/L 12	6407308 / 6407307	40	37	400	24,1	27	49		
	S50W-PCLNR/L 16	6407329 / 6407328	50	47	450	31	35	62	CN.. 16..	36-40
	S40S-29629 12	6407298	40	-	250	80	40	45	CN.. 12..	36-39
	S50S-29529 12	6407325	50	-	250	100	50	55		





A = Stahlschaft mit Kühlbohrung Steel shank with coolant hole
 S = Stahlschaft Steel shank

Rechtsausführung wie gezeichnet, Linksausführung spiegelbildlich
 Righthand version as shown, lefthand version mirrorlike

Ersatzteile Spare parts		Bestellbezeichnung Ordering Code					
Schneid- kantenlänge Cutting edge length	Schaftdurch- messer Ø d Shank diameter Ø d	Unterlage Shim	Hebel Lever	Spann- schraube Fixation screw	Spannhülse Shim pin	Montagedorn Assembly punch	Schlüssel Key
12	25-32	B01-C1231	D02-12130	A03-08170	E01-07205	V10-20000	V01-A0030
12	40-50	B01-C1231	D02-12130	A03-08210	E01-07205	V10-20000	V01-A0030
16	50	B01-C1547	D02-15173	A03-08235	E01-09008	V10-40000	V01-A0030

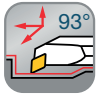
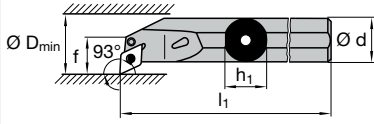
Bestellbeispiel: 1 Stück A25R-PCLNR 12
 Order example: 1 piece A25R-PCLNR 12

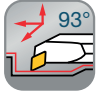
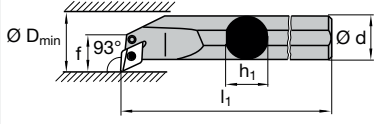
Lieferung ohne Schlüssel
 Delivery without key

											Passende Wende- platten Suitable inserts	Seite Page
	Bestellbezeichnung Ordering Code	Ident No.	d	h ₁	l ₁	l ₂	f	D _{min}				
PDUN-R/L   	A20Q-PDUNR/L 11	6401452 / 6401451	20	19	180	-	16	27		DN.. 11..	43-44	
	A25R-PDUNR/L 11	6401490 / 6401489	25	24	200	-	18,5	32				
	A32S-PDUNR/L 11	6401560 / 6401558	32	31	250	-	22	40				
		A32S-PDUNR/L 15	6401561 / 6401559	32	31	250	-	22	40		DN.. 15..	43-46
		A40T-PDUNR/L 15	6401600 / 6401599	40	39	300	-	27	49			
		S40V-PDUNR/L 15	6407310 / 6407309	40	37	400	-	27	49			
		S50W-PDUNR/L 15	6407331 / 6407330	50	47	450	-	35	62			
PDUN-R/L 14   	S32T-PDUNR/L 14	6407270 / 6407269	32	30	300	-	22	40		DNMG 14..	45	
	S40U-PDUNR/L 14	6407304 / 6407303	40	38	350	-	27	50				

A = Stahlschaft mit Kühlbohrung Steel shank with coolant hole
 S = Stahlschaft Steel shank

Rechtsausführung wie gezeichnet, Linksausführung spiegelbildlich
 Righthand version as shown, lefthand version mirrorlike

Ersatzteile Spare parts		Bestellbezeichnung Ordering Code					
Schneid- kantenlänge Cutting edge length	Schaftdurch- messer Ø d Shank diameter Ø d	 Unterlage Shim	 Hebel Lever	 Spann- schraube Fixation screw	 Spannhülse Shim pin	 Montagedorn Assembly punch	 Schlüssel Key
11	20	-	D02-11105	A03-06135	-	V10-10000	V01-A0025
11	25-32	B01-D1131	D02-10120	A03-06170	E01-05405	V10-10000	V01-A0025
14	32-40	B01-D1331	D02-15145	A03-08210	E01-07205	V10-20000	V01-A0030
15 ¹⁾	32-50	B01-D1448	D02-15145	A03-08210	E01-07205	V10-20000	V01-A0030
15 ²⁾	32-50	B01-D1447	D02-15145	A03-08210	E01-07205	V10-20000	V01-A0030
15 ³⁾	32-50	B01-D1432	D02-15145	A03-08210	E01-07205	V10-20000	V01-A0030
15 ³⁾	32-50	B01-D1431	D02-15145	A03-08210	E01-07205	V10-20000	V01-A0030

Für WSP DNMG 1504../ for insert DNMG 1504..

Für WSP DNMG 1506../ for insert DNMG 1506..

¹⁾ s = 4,76 mm, r = 0,4; 0,8 mm

³⁾ s = 6,35 mm, r = 0,4; 0,8 mm

²⁾ s = 4,76 mm, r = 1,2; 1,6 mm





⁴⁾ s = 6,35 mm, r = 1,2; 1,6 mm

Bestellbeispiel: 1 Stück A20Q-PDUNR 11

Lieferung ohne Schlüssel

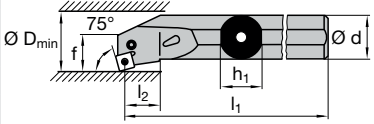
Order example: 1 piece A20Q-PDUNR 11

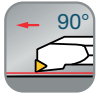
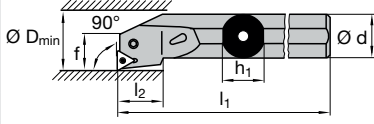
Delivery without key

	Bestellbezeichnung Ordering Code	Ident No.	d	h₁	l₁	l₂	f	D_{min}	Passende Wende- platten Suitable inserts	Seite Page
PSKN-R/L   	A25R-PSKNR/L 12	6401492 / 6401491	25	24	200	15,5	17	31,5	SN.. 12..	49-52
	A32S-PSKNR/L 12	6401563 / 6401562	32	31	250	16	22	40		
	A40T-PSKNR/L 12	6401602 / 6401601	40	39	300	23	27	49		
	S50W-PSKNR/L 15	6407333 / 6407332	50	47	450	30	35	62	SN.. 15..	50-52
PTFN-R/L   	A25R-PTFNR/L 16	6401494 / 6401493	25	24	200	17,5	17	31,5	TN.. 16..	53-55
	S25T-PTFNR/L 16	6407251 / 6407250	25	23	300	17,5	17	32		
	A32S-PTFNR/L 16	6401565 / 6401564	32	31	250	18	22	40		
	A40T-PTFNR/L 22	6401604 / 6401603	40	39	300	27	27	49	TN.. 22..	53-55
	S50W-PTFNR/L 22	6407335 / 6407334	50	47	450	35	35	62		



A = Stahlschaft mit Kühlbohrung Steel shank with coolant hole
 S = Stahlschaft Steel shank

Rechtsausführung wie gezeichnet, Linksausführung spiegelbildlich
 Righthand version as shown, lefthand version mirrorlike

Ersatzteile Spare parts		Bestellbezeichnung Ordering Code					
							
Schneid- kantenlänge Cutting edge length	Schaftdurch- messer Ø d Shank diameter Ø d	Unterlage Shim	Hebel Lever	Spann- schraube Fixation screw	Spannhülse Shim pin	Montagedorn Assembly punch	Schlüssel Key
12	25-32	B01-S1231	D02-12130	A03-08170	E01-07205	V10-20000	V01-A0030
12	40	B01-S1231	D02-12130	A03-08210	E01-07210	V10-20000	V01-A0030
15	50	B01-S1547	D02-15173	A03-08235	E01-09008	V10-40000	V01-A0030
							
16	25-32	B01-T1527	D02-09120	A03-06170	E01-05405	V10-10000	V01-A0025
22	40-50	B01-T2031	D02-12130	A03-08210	E01-07205	V10-20000	V01-A0030



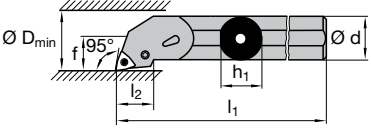



Bestellbeispiel: 1 Stück A25R-PSKNR 12
 Order example: 1 piece A25R-PSKNR 12

Lieferung ohne Schlüssel
 Delivery without key

	Bestellbezeichnung Ordering Code	Ident No.	d	h₁	l₁	l₂	f	D_{min}	Passende Wende- platten Suitable inserts	Seite Page
PWLN-R/L   	A16M-PWLN/R/L 06	6401408 / 6401407	16	15,25	150	17,5	11	21	WN.. 06..	58-60
	A20Q-PWLN/R/L 06	6401454 / 6401453	20	19	180	19,5	13	25		
	A25R-PWLN/R/L 06	6401496 / 6401495	25	24	200	19,5	17	32		
	A32S-PWLN/R/L 08	6401567 / 6401566	32	31	250	26	22	40	WN.. 08..	58-61
	A40T-PWLN/R/L 08	6401606 / 6401605	40	38,5	300	26	27	49		





A = Stahlschaft mit Kühlbohrung Steel shank with coolant hole

Rechtsausführung wie gezeichnet, Linksausführung spiegelbildlich
 Righthand version as shown, lefthand version mirrorlike

Ersatzteile Spare parts		Bestellbezeichnung Ordering Code					
Schneid- kantenlänge Cutting edge length	Schaftdurch- messer Ø d Shank diameter Ø d	 Unterlage Shim	 Hebel Lever	 Spann- schraube Fixation screw	 Spannhülse Shim pin	 Montagedorn Assembly punch	 Schlüssel Key
06	16-20	-	D02-09093	A03-05120	-	-	V01-A0020
06	25	B01-W0627	D02-09120	A03-06170	E01-05405	V10-10000	V01-A0025
08	32-40	B01-W0831	D02-12130	A03-08210	E01-07205	V10-20000	V01-A0030

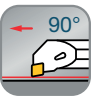
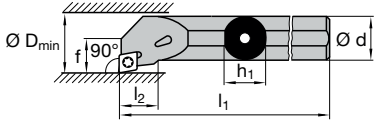

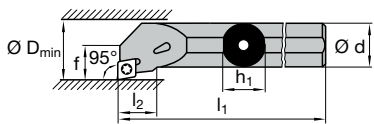
Bestellbeispiel: 1 Stück A16M-PWLN/R 06
 Order example: 1 piece A16M-PWLN/R 06

Lieferung ohne Schlüssel
 Delivery without key

	Bestellbezeichnung Ordering Code	Ident No.	d	h ₁	l ₁	l ₂	f	D _{min}	Passende Wende- platten Suitable inserts	Seite Page		
SCFC-R/L   	A08F-SCFCR/L 06	6401298 / 6401297	8	7,5	80	-	5	11	CC.. 06..	34-35		
	A10H-SCFCR/L 06	6401333 / 6401332	10	9,5	100	9	7	14				
	A12K-SCFCR/L 06	6401358 / 6401357	12	11,5	125	14	9	17				
	SCLC-R/L   	A08F-SCLCR/L 06	6401300 / 6401299	8	7,5	80	-	5	11	CC.. 06..	34-35	
E08H-SCLCR/L 06		6404753 / 6404752	8	7,5	100	-	5	11				
S08H-SCLCR/L 06		6407199 / 6407198	8	7	100	-	5	11				
A10H-SCLCR/L 06		6401335 / 6401334	10	9,5	100	10	7	13				
E10K-SCLCR/L 06		6404765 / 6404764	10	9,5	125	10	7	14				
S10K-SCLCR/L 06		6407203 / 6407202	10	9	125	10	7	13				
A12K-SCLCR/L 06		6401360 / 6401359	12	11,5	125	10	9	16				
E12Q-SCLCR/L 06		6404774 / 6404773	12	11,5	180	10	9	17				
S12Q-SCLCR/L 06		6407207 / 6407206	12	11	180	10	9	16				
A16M-SCLCR/L 09		6401410 / 6401409	16	15,5	150	16	11	20	CC.. 09..			34-35
E16R-SCLCR/L 09		6404802 / 6404801	16	15,5	200	16	11	21				
S16R-SCLCR/L 09		6407213 / 6407212	16	15	200	16	11	20				
A20Q-SCLCR/L 09		6401456 / 6401455	20	19	180	16	13	25				
E20S-SCLCR/L 09		6404854 / 6404853	20	19	250	16	13	25				
S20S-SCLCR/L 09		6407229 / 6407228	20	18	250	16	13	25				
A25R-SCLCR/L 09		6401498 / 6401497	25	24	200	16	17	31,5				
E25T-SCLCR/L 09		6404886 / 6404885	25	24	300	16	17	31,5				
S25T-SCLCR/L 09		6407255 / 6407253	25	23	300	16	17	31,5	CC.. 12..	34-35		
A32S-SCLCR/L 12		6401569 / 6401568	32	31	250	22	22	40				
A40T-SCLCR/L 12		6401608 / 6401607	40	38,5	300	22	27	49				
S25T-SCLCR/L 12	6407256 / 6407254	25	23	300	16	17	31,5					

A = Stahlschaft mit Kühlbohrung Steel shank with coolant hole
 S = Stahlschaft Steel shank
 E = Hartmetall-Schaft mit Stahlkopf und Kühlbohrung
 Carbide shank with steel head and coolant hole

Rechtsausführung wie gezeichnet, Linksausführung spiegelbildlich
 Righthand version as shown, lefthand version mirrorlike

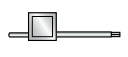
Ersatzteile Spare parts		Bestellbezeichnung Ordering Code					
Schneid- kantenlänge Cutting edge length	Schaftdurch- messer Ø d Shank diameter Ø d	 Unterlage Shim	 Gewindehülse Shim screw	 Klemm- schraube Fixation screw	 Schlüssel Key		
06	08-12	-	-	A02-25059	V02-T0800		
09	16-20	-	-	A02-35082	V02-T1500		
09	25	-	-	A02-35096	V02-T1500		
12	32-40	B09-C1231	E09-F6045	A02-45102	V05-T1534		

Bestellbeispiel: 1 Stück A08F-SCFCR 06
 Order example: 1 piece A08F-SCFCR 06

Lieferung ohne Schlüssel
 Delivery without key

	Bestellbezeichnung Ordering Code	Ident No.	d	h ₁	l ₁	l ₂	f	D _{min}	Passende Wende- platten Suitable inserts	Seite Page	
	A10H-SDQCR/L 07	6410851 / 6410850	10	9	100	10	7	14	DC.. 07..	40-42	
	A12K-SDQCR/L 07	6401362 / 6401361	12	11,5	125	12,5	9	17			
	A16M-SDQCR/L 07	6401412 / 6401411	16	15,5	150	16,5	11	21			
		A20Q-SDQCR/L 07	6401458 / 6401457	20	19	180	20,5	13	25	DC.. 11..	40-42
		A25R-SDQCR/L 11	6401500 / 6401499	25	24	200	26,5	17	31,5		
		A32S-SDQCR/L 11	6401571 / 6401570	32	31	250	33,5	22	40		
A40T-SDQCR/L 11		6401610 / 6401609	40	38,5	300	41,5	27	49			
	A12K-SDUCR/L 07	6401364 / 6401363	12	11,5	125	12,5	9	17	DC.. 07..	40-42	
	E12Q-SDUCR/L 07	6404776 / 6404775	12	11,5	180	12,5	9	17			
	S12Q-SDUCR/L 07	6407209 / 6407208	12	11	180	12,5	9	17			
		A16M-SDUCR/L 07	6401414 / 6401413	16	15,5	150	16,5	11	21	DC.. 11..	40-42
		E16R-SDUCR/L 07	6404804 / 6404803	16	15,5	200	16,5	11	21		
		S16R-SDUCR/L 07	6407215 / 6407214	16	15	200	16,5	11	21		
		A20Q-SDUCR/L 07	6401461 / 6401459	20	19	180	20,5	13	25		
		S20S-SDUCR/L 07	6407232 / 6407230	20	18	250	20,5	13	25		
		A20Q-SDUCR/L 11	6401462 / 6401460	20	19	180	21	13	25		
		E20S-SDUCR/L 11	6404856 / 6404855	20	19	250	20,5	13	25		
		S20S-SDUCR/L 11	6407233 / 6407231	20	18	250	21	13	25		
		A25R-SDUCR/L 11	6401502 / 6401501	25	24	200	26	17	31,5		
		E25T-SDUCR/L 11	6404888 / 6404887	25	24	300	26	17	31,5		
		S25T-SDUCR/L 11	6407260 / 6407259	25	23	300	26	17	31,5		
		A32S-SDUCR/L 11	6401573 / 6401572	32	31	250	50	22	40		
		S32U-SDUCR/L 11	6407289 / 6407288	32	30	350	33	22	40		
A40T-SDUCR/L 11	6401612 / 6401611	40	38,5	300	33	27	49				

A = Stahlschaft mit Kühlbohrung Steel shank with coolant hole
 S = Stahlschaft Steel shank
 E = Hartmetall-Schaft mit Stahlkopf und Kühlbohrung
 Carbide shank with steel head and coolant hole

Rechtsausführung wie gezeichnet, Linksausführung spiegelbildlich
 Righthand version as shown, lefthand version mirrorlike

Ersatzteile Spare parts		Bestellbezeichnung Ordering Code					
Schneid- kantenlänge Cutting edge length	Schaftdurch- messer Ø d Shank diameter Ø d	Unterlage Shim	Gewindehülse Shim screw	Klemm- schraube Fixation screw	Schlüssel Key		
07	12-20	-	-	A02-25059	V02-T0800		
11	20	-	-	A02-35072	V02-T1500		
11	25-40	B09-D1131	E09-F5035	A02-35096	V05-T1534		

Bestellbeispiel: 1 Stück A10H-SDQCR 07
 Order example: 1 piece A10H-SDQCR 07

Lieferung ohne Schlüssel
 Delivery without key

		Bestellbezeichnung Ordering Code	Ident No.	d	h₁	l₁	l₂	f	D_{min}	Passende Wende- platten Suitable inserts	Seite Page	
	STFC-R/L	A12K-STFCR/L 11	6401366 / 6401365	12	11,5	125	13	9	17	TC.. 11..	52-53	
	S12Q-STFCR/L 11	6407211 / 6407210	12	11	180	13	9	17				
	A16M-STFCR/L 11	6401416 / 6401415	16	15,5	150	13	11	21				
	S16R-STFCR/L 11	6407217 / 6407216	16	15	200	13	11	21				
	A20Q-STFCR/L 11	6401464 / 6401463	20	19	180	13	13	25				
			S20S-STFCR/L 11	6407235 / 6407234	20	18	250	13	13	25	TC.. 16..	52-53
			A25R-STFCR/L 16	6401504 / 6401503	25	24	200	21	17	31,5		
			S25T-STFCR/L 16	6407262 / 6407261	25	23	300	21	17	31,5		
			A32S-STFCR/L 16	6401575 / 6401574	32	31	250	21	22	40		
			S32U-STFCR/L 16	6407291 / 6407290	32	30	350	21	22	40		
			A40T-STFCR/L 16	6401614 / 6401613	40	38,5	300	21	27	49		
		S40V-STFCR/L 16	6407318 / 6407317	40	37	400	21	27	49			
	SVLC-R/L	A10H-SVLCR/L 07	6437515 / 6426806	10	-	100	22	7	12,5	VC.. 07..	56-57	
		A12K-SVLCR/L 07	6437519 / 6437518	12	-	125	28	9	15,5			
		A16M-SVLCR/L 07	6437523 / 6437522	16	-	150	36	11	19,5			
	SVOC-R/L	A10H-SVOCR/L 07	6437517 / 6437516	10	-	100	-	5,4	11	VC.. 07..	56-57	
		A12K-SVOCR/L 07	6437521 / 6437520	12	-	125	-	5,4	11			
		A16M-SVOCR/L 11	6437525 / 6437524	16	-	150	16	11	20			VC.. 11..







A = Stahlschaft mit Kühlbohrung Steel shank with coolant hole
S = Stahlschaft Steel shank

Rechtsausführung wie gezeichnet, Linksausführung spiegelbildlich
Righthand version as shown, lefthand version mirrorlike

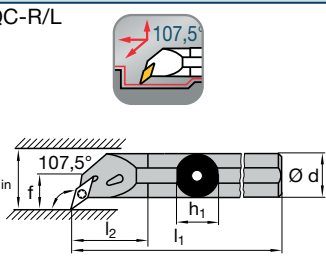
Ersatzteile Spare parts		Bestellbezeichnung Ordering Code			
Schneid- kantenlänge Cutting edge length	Schaftdurch- messer Ø d Shank diameter Ø d	Unterlage Shim	Gewindehülse Shim screw	Klemm- schraube Fixation screw	Schlüssel Key
11	12-20	-	-	A02-25059	V02-T0800
16	25-40	B09-T1631	E09-F5035	A02-35082	V05-T1534

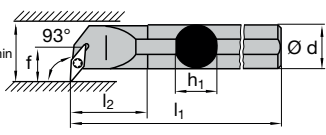

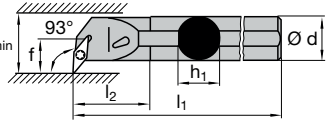
Bestellbeispiel: 1 Stück A12K-STFCR 11
Order example: 1 piece A12K-STFCR 11

Lieferung ohne Schlüssel
Delivery without key

	Bestellbezeichnung Ordering Code	Ident No.	d	h ₁	l ₁	l ₂	f	D _{min}	Passende Wende- platten Suitable inserts	Seite Page
	A16M-SVQCR/L 11	6401418 / 6401417	16	15,5	150	16,5	11	21	VC.. 11..	56-57
	A20Q-SVQCR/L 11	6401466 / 6401465	20	19	180	20,5	13	25		
	A25R-SVQCR/L 11	6401506 / 6401505	25	24	200	25,5	17	31,5	VC.. 16..	56-57
	A32S-SVQCR/L 16	6401577 / 6401576	32	31	250	33,5	22	40		
	A40T-SVQCR/L 16	6401616 / 6401615	40	38,5	300	40	27	49		
										
	S32T-SVUBR/L 16	6407276 / 6407275	32	30	300	60	22	40	VB.. 16..	56
										
	A16M-SVUCR/L 11	6401420 / 6401419	16	15,5	150	16,5	11	21	VC.. 11..	56-57
	E16R-SVUCR/L 11	6404806 / 6404805	16	15,5	200	16,5	11	21		
	A20Q-SVUCR/L 11	6401468 / 6401467	20	19	180	20,5	13	25	VC.. 16..	56-57
	E20S-SVUCR/L 11	6404858 / 6404857	20	19	250	20,5	13	25		
	A25R-SVUCR/L 11	6401508 / 6401507	25	24	200	25,5	17	31,5		
	E25T-SVUCR/L 11	6404890 / 6404889	25	24	300	25,5	17	31,5	VC.. 16..	56-57
	A32S-SVUCR/L 16	6401579 / 6401578	32	31	250	33,5	22	40		
A40T-SVUCR/L 16	6401618 / 6401617	40	38,5	300	40	27	49			
										

A = Stahlschaft mit Kühlbohrung Steel shank with coolant hole
 S = Stahlschaft Steel shank
 E = Hartmetall-Schaft mit Stahlkopf und Kühlbohrung
 Carbide shank with steel head and coolant hole

Rechtsausführung wie gezeichnet, Linksausführung spiegelbildlich
 Righthand version as shown, lefthand version mirrorlike

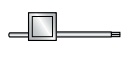
Ersatzteile Spare parts			Bestellbezeichnung Ordering Code			
Schneid- kantenlänge Cutting edge length	Wendeplatte Indexable insert	Schaftdurch- messer Ø d Shank diameter Ø d	 Unterlage Shim	 Gewindehülse Shim screw	 Klemm- schraube Fixation screw	 Schlüssel Key
11	VC...	16-25	-	-	A02-25059	V02-T0800
16	VC...	32-40	B09-V1602	E09-F5035	A02-35096	V05-T1534
r = 0,4-0,8	VB...	32	B02-V1431	E02-F5035	A02-35096	V05-T1534
16	VC...	32-40	B09-V1606	E09-F5035	A02-35096	V05-T1534
r = 1,2	VB...	32	B02-V1431	E02-F5035	A02-35096	V05-T1534

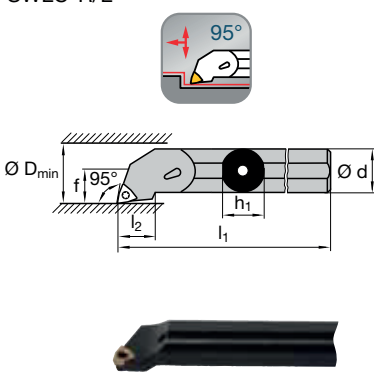

Bestellbeispiel: 1 Stück A16M-SVQCR 11
 Order example: 1 piece A16M-SVQCR 11

Lieferung ohne Schlüssel
 Delivery without key

	Bestellbezeichnung Ordering Code	Ident No.	d	h ₁	l ₁	l ₂	f	D _{min}	Passende Wende- platten Suitable inserts	Seite Page
	A16M-SWLCR/L 06	6401422 / 6401421	16	15,5	150	-	11	21	WC.. 06T3..	58
	E16R-SWLCR/L 06	6404808 / 6404807	16	15	200	-	11	21	WCGT 06T3..	
	S16R-SWLCR/L 06	6407223 / 6407222	16	15	200	-	11	21	WC.. 06T3..	58
	A20Q-SWLCR/L 06	6401470 / 6401469	20	19	180	-	13	25		
	E20S-SWLCR/L 06	6404860 / 6404859	20	19	250	-	13	25		
	S20S-SWLCR/L 06	6407241 / 6407240	20	18	250	-	13	25		
	A25R-SWLCR/L 06	6401510 / 6401509	25	24	200	-	17	31,5		
	E25T-SWLCR/L 06	6404892 / 6404891	25	24	300	-	17	31,5		
	S25T-SWLCR/L 06	6407268 / 6407267	25	23	300	-	17	31,5		
	A32S-SWLCR/L 08	6401581 / 6401580	32	31	250	-	22	40	WC.. 08..	58
	S32U-SWLCR/L 08	6407297 / 6407296	32	30	350	-	22	40		
	A40T-SWLCR/L 08	6401620 / 6401619	40	38,5	300	-	27	49		
	S40V-SWLCR/L 08	6407324 / 6407323	40	37	400	-	27	49		

A = Stahlschaft mit Kühlbohrung Steel shank with coolant hole
 S = Stahlschaft Steel shank
 E = Hartmetall-Schaft mit Stahlkopf und Kühlbohrung
 Carbide shank with steel head and coolant hole

Rechtsausführung wie gezeichnet, Linksausführung spiegelbildlich
 Righthand version as shown, lefthand version mirrorlike

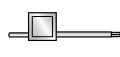

Ersatzteile Spare parts		Bestellbezeichnung Ordering Code					
Schneid- kantenlänge Cutting edge length	Schaftdurch- messer Ø d Shank diameter Ø d	 Unterlage Shim	 Gewindehülse Shim screw	 Klemm- schraube Fixation screw	 Schlüssel Key		
06	16-25	-	-	A02-35082	V02-T1500		
08	32-40	B09-W0831	E09-F6045	A02-45102	V05-T1534		

Bestellbeispiel: 1 Stück A16M-SWLCR 06
 Order example: 1 piece A16M-SWLCR 06

Lieferung ohne Schlüssel
 Delivery without key

C-Klemmhalter Innenbearbeitung

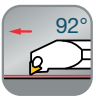
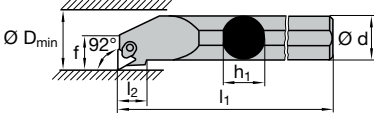
Tool holders type C, internal machining

	Bestellbezeichnung Ordering Code	Ident No.	d	h ₁	l ₁	l ₂	f	D _{min}	Passende Wende- platten Suitable inserts	Seite Page
  	S74P-16R/LTP 11	6407343 / 6407342	16	14	180	14	10,7	20	TPMR 11..	55
	S74P-20R/LTP 11	6407345 / 6407344	20	18	250	14	13,8	27		
	S74P-25R/LTP 16	6407347 / 6407346	25	23	300	20	17,7	34	TPMR 16..	55
	S74P-32R/LTP 16	6407349 / 6407348	32	30	350	20	22,2	43		
	S74P-40RTP 16	6407350	40	37	350	20	27,7	58		

S = Stahlschaft Steel shank

Rechtsausführung wie gezeichnet, Linksausführung spiegelbildlich
Righthand version as shown, lefthand version mirrorlike

Ersatzteile Spare parts		Bestellbezeichnung Ordering Code					
Schneid- kantenlänge Cutting edge length	Schaftdurch- messer Ø d Shank diameter Ø d	 Unterlage Shim	 Rohrstift Shim pin	 Klemmfinger Clamp	 Schlüssel Key		
09	16-20	-	-	33.01.05	V02-T1000		
12	25-32	33.03.54	33.04.04	33.01.06	V02-T2000		
							
09	12	-	-	33.01.04	V02-T0800		
11	16-20	-	-	33.01.05	V02-T1000		
16	25-40	33.03.04	33.04.04	33.01.06	V02-T2000		

Bestellbeispiel: 1 Stück S74P-16RTR 11
Order example: 1 piece S74P-16RTP11

Lieferung ohne Schlüssel
Delivery without key

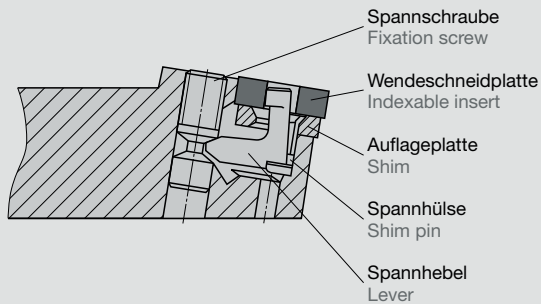

P-Hebelspannsystem

- Geeignet für alle Wendeschneidplatten nach DIN 4988
- Wenig Ersatzteile, keine losen Teile
- Ungehindertes Spanablauf, da kein störender Aufbau
- Einwandfreies Lösen der Schneidplatte durch Zwangsentspannen
- Schnelles, sicheres Spannen der Wendeschneidplatte

P-lever clamping system

- Suitable for all indexable inserts in compliance with DIN 4988
- Few spare parts, no loose parts
- Unimpeded chip removal as there is no troublesome build-up
- Perfect insert removal thanks to forced release mechanism
- Fast and secure clamping of indexable insert

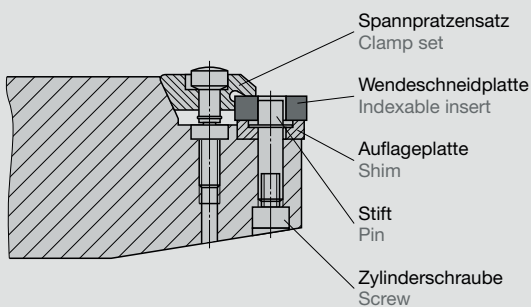

M bzw. D-Keilspannpratzensystem

- Schnelles, sicheres Spannen durch Keil- und Spannpratze
- Schneidplatte ist an Haupt- und Nebenschneide frei
- Vorteilhaft vor allem bei Kopierarbeiten
- Besonders ausgebildeter Spannkeil bringt optimalen Spanfluss

M- or D-wedge clamp system

- Fast and secure clamping using wedges and clamps
- Insert is free around the primary and secondary cutting edges
- Especially well-suited to copy machining
- Specially shaped clamping wedge provides ideal chip flow

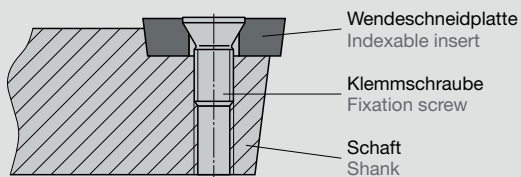





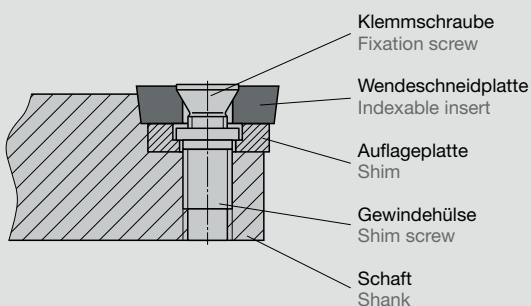













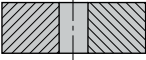
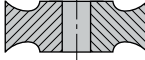
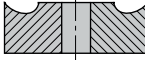
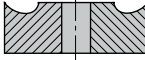





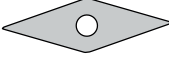



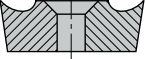
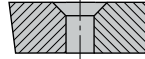
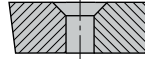

S-Schraubspannsystem

- Einfache und sichere Befestigung der Schneidplatte durch kegelige Positionierungsschraube
- Keine Beeinträchtigung des Spanablaufes
- Maximal 3 Ersatzteile

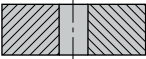
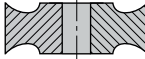
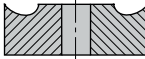
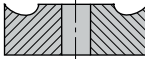

S-screw clamp system

- Simple and secure fixing of the indexable insert using a tapered positioning screw
- Flow of chips is not obstructed
- Maximum of 3 replacement parts

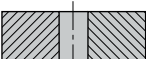
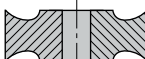
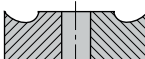
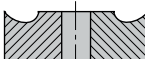
P-Klemmhalter P-type tool holders 	Bearbeitungsart Process type	Außen External	Innen Internal
	Schruppen Roughing	sehr gut very good	sehr gut very good
	Schlichten Finishing	gut good	gut good
	Plattenform Shape of the indexable insert	     	 
Plattentyp Type of the indexable insert	  		
S-Klemmhalter S-type tool holders 	Bearbeitungsart Process type	Außen External	Innen Internal
	Schruppen Roughing	geeignet suitable	geeignet suitable
	Schlichten Finishing	sehr gut very good	sehr gut very good
	Plattenform Shape of the indexable insert	      	 
Plattentyp Type of the indexable insert	 		
M-Klemmhalter M-type tool holders 	Bearbeitungsart Process type	Außen External	Innen Internal
	Schruppen Roughing	geeignet suitable	geeignet suitable
	Schlichten Finishing	gut good	sehr gut very good
	Plattenform Shape of the indexable insert	  	
Plattentyp Type of the indexable insert	  		
D-Klemmhalter D-type tool holders 	Bearbeitungsart Process type	Außen External	Innen Internal
	Schruppen Roughing	geeignet suitable	geeignet suitable
	Schlichten Finishing	gut good	sehr gut very good
	Plattenform Shape of the indexable insert	  	
Plattentyp Type of the indexable insert	  		

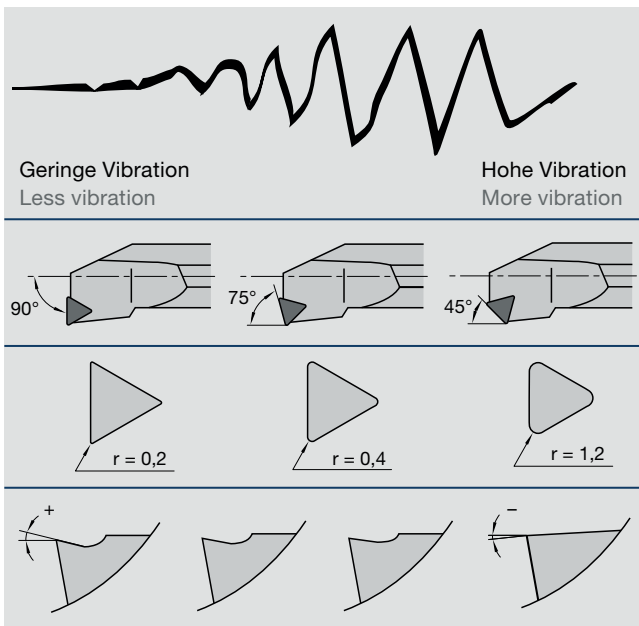
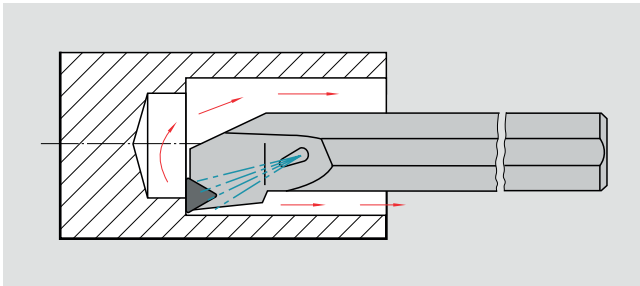
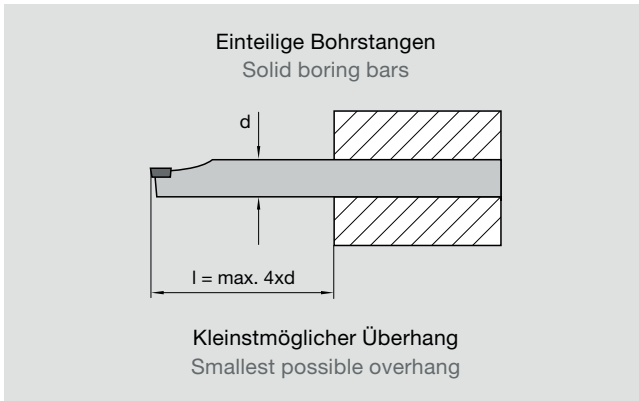

Allgemeine Empfehlungen

- Den größtmöglichen Schaftdurchmesser wählen.
- Kleinstmöglichen Überhang wählen.
- Korrekte und stabile Einspannung für die Bohrstange wählen.
- Kühlschmierstoff (oder Druckluft) können den Spantransport und die Oberflächengüte, besonders bei tiefen Bohrungen, verbessern.

General recommendations

- Use the largest possible shank diameter.
- Use the smallest possible overhang.
- Use the correct, stable clamping method for the boring bar.
- Cooling lubricant (or compressed air) can improve chip transport and the surface quality, particularly with deep bores.

Faktoren, die bei der Wahl der Bohrstangen für vibrationsanfällige Bearbeitungen eine Rolle spielen

- Der Einstellwinkel sollte so nahe wie möglich an 90° und nicht unter 75° liegen.
- Kleinen Eckenradius wählen.
- Positive Halter (S-Klemmhalter) und Wendeschneidplatten wählen.
- Unbeschichtete Sorten haben in der Regel schärfere Schneidkanten und erzeugen daher geringere Schnittkräfte.

Factors to consider when selecting boring bars for work susceptible to vibration:

- The approach angle should be as close as possible to 90° and not be below 75°.
- Select a small corner radius.
- Use positive holders (S-clamp holder) and indexable inserts.
- Uncoated grades generally have sharper cutting edges and therefore generate less cutting force.

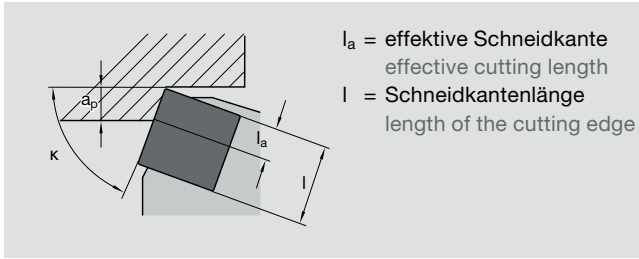

Spantiefe

- Bestimmen der größten Spantiefe a_p .
- Erforderliche effektive Schneidkantenlänge l_a bestimmen. Dabei sind der Anstellwinkel κ und die Spantiefe a_p zu berücksichtigen.
- Die kleinste erforderliche Schneidkantenlänge l_a kann aus der Tabelle links abgelesen werden.

Anstellwinkel Angle of approach κ	Spantiefe (a_p) mm Depth of cut (a_p) mm														
	1	2	3	4	5	6	7	8	9	10	15				
	Erforderliche effektive Schneidkantenlänge (l_a) mm Required effective length of the cutting edge (l_a) mm														
90	1	2	3	4	5	6	7	8	9	10	15				
105 75	1,1	2,1	3,1	4,1	5,2	6,2	7,3	8,3	9,3	11	16				
120 60	1,2	2,3	3,5	4,7	5,8	7	8,2	9,3	11	12	18				
135 45	1,4	2,9	4,3	5,7	7,1	8,5	10	12	13	15	22				
150 30	2	4	6	8	10	12	14	16	18	20	30				
165 15	4	8	12	16	20	24	27	31	35	39	58				

Depth of cut

- Determine the largest depth of cut a_p .
- Determine the effective length of cutting edge (l_a) required. The setting angle (κ) and the depth of cut (a_p) should be taken into consideration.
- The smallest length of cutting edge (l_a) required can be found in the table to the left.

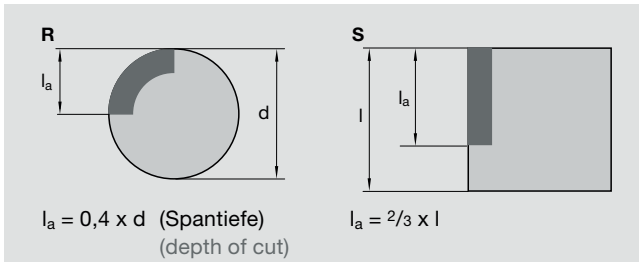

Effektive Schneidkantenlänge

Der Spitzenwinkel einer Wendschneidplatte hat einen großen Einfluss auf die Schneidkantenstabilität. Jede Wendschneidplatte hat eine maximale effektive Schneidkantenlänge. Die in der Tabelle angeführten maximalen Werte sind für eine Bearbeitungssicherheit beim Schruppen ohne unterbrochenen Schnitt ausgelegt.

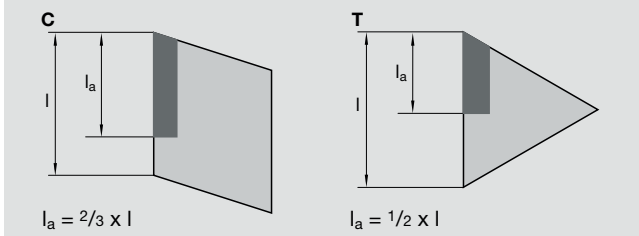

Falls die effektive Schneidkantenlänge niedriger als die Spantiefe ist, sollte eine größere Wendeplatte gewählt oder die Spantiefe reduziert werden.

Für zusätzliche Sicherheit bei anspruchsvollen Zerspanaufgaben sollte eine größere und dickere Wendschneidplatte eingesetzt werden. Beim Drehen gegen eine Schulter kann sich die Spantiefe erheblich erhöhen. Damit es hier nicht zu Problemen kommt, sollte eine größere Wendschneidplatte verwendet oder eine zusätzliche Plandrehoperation durchgeführt werden.

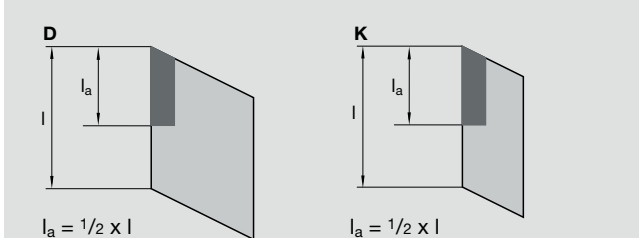

The effective length of the cutting edge

The point angle of an indexable insert has a great influence on the stability of the cutting edges. Every indexable insert has a maximum effective cutting edge length. The maximum values given in the table are designed for working safety when rough cutting with a continuous cut.

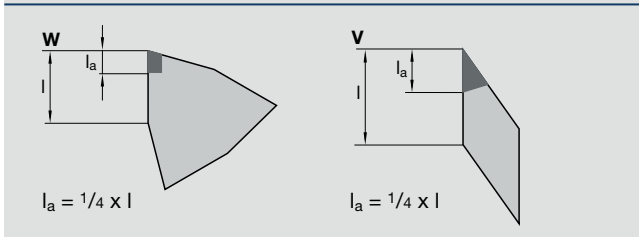

If the effective length of the cutting edges is lower than the depth of cut, a larger indexable insert should be used or the depth of cut should be reduced.

For additional safety during difficult cutting jobs, a larger or thicker indexable insert should be used. When turning against a shoulder, the depth of cut can be increased considerably. So that no problems arise here, a larger indexable insert should be used or an additional face turning operation should be performed.

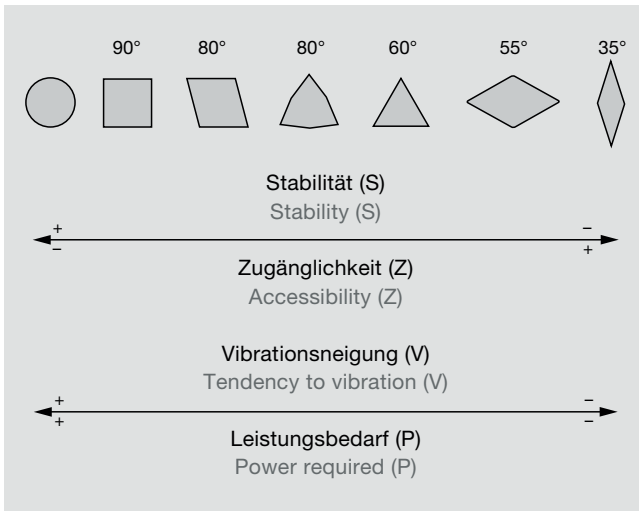

Wendeplattenform

Die Abbildung zeigt die gebräuchlichsten ISO-Plattenformen von der runden bis hin zur 35° Wendschneidplatte.

Die Pfeilskala zeigt, dass die Schneidkantenstabilität (S) mit größer werdendem Eckenwinkel zunimmt.

Je kleiner der Eckenwinkel, umso besser ist die Zugänglichkeit (Z).

Die Pfeilskala zeigt, dass die Vibrationsneigung (V) links ansteigt, während der Leistungsbedarf (P) rechts niedriger ist.

Beim Drehen von Formen darf beim Einwärtskopieren der maximale Kopierwinkel nicht überschritten werden. Der Winkel zwischen der Nebenschneide und der erzeugten Werkstückform sollte mindestens 2° betragen.

Indexable insert shape

The diagram shows the most common indexable insert shapes from round tips right down to 35° indexable inserts.

The arrow on the scale shows that the stability of the cutting edge (S) grows with increasing point angle, Whereas the accessibility (Z) becomes improved by smaller point angles.

Tendency to vibration (V) and power requirement (P) rise with larger point angles.

When turning shapes the maximum copy angle must not be exceeded for inward copying. The angle between the secondary cutting edge and the workpiece shape produced should be at least 2°.

Eckenradius (r) mm Corner radius (r) mm	0,4	0,8	1,2	1,6	2,4
Max. empf. Vorschub (f _r) mm/U Recommended max. feed rate (f _r) mm/rev	0,25–0,35	0,4–0,7	0,5–1,0	0,7–1,3	1,0–1,8

Eckenradius und Vorschub

Der Eckenradius der Wendeschneidplatte ist ein Schlüsselfaktor in Bezug auf:

- Stabilität beim Schrappen.
- Oberflächengüte beim Schlichten.

Schrappbearbeitung

- Größtmöglichen Eckenradius wählen, um eine möglichst stabile Schneidkante zu gewährleisten.
- Ein großer Eckenradius erlaubt größere Vorschübe.
- Bei Vibrationsgefahr kleineren Eckenradius wählen.

Bei der Wahl des Vorschubs für die Schrappdrehbearbeitung dürfen die maximalen Vorschubwerte wie oben genannt auf keinen Fall überschritten werden. Als Grundregel gilt:

$$f_r \text{ Schrappen} = 0,5 \times \text{Eckenradius}$$

Maximaler Vorschub für verschiedene Eckenradien

Die bei der Schrappbearbeitung am häufigsten verwendeten Radien betragen 1,2 - 1,6 mm.

Die Tabelle basiert auf der max. empfohlenen Vorschubgeschwindigkeit von $\frac{2}{3}$ des Eckenradius.

Höhere Vorschübe sind möglich bei:

- Wendeschneidplatten mit stabiler Schneidkante und Spitzenwinkel von min. 60°.
- Einseitigen Wendeschneidplatten.
- Wendeschneidplatten, die mit einem Anstellwinkel unter 90° eingesetzt werden.
- Bearbeitungen von gut zerspanbaren Werkstückstoffen mit mittleren Schnittgeschwindigkeiten.

Corner radius and feed

The corner radius of the indexable insert is a key factor with regard to:

- Stability during rough cutting.
- Surface quality during finishing.

Roughing

- Use the largest possible corner radius to ensure the greatest degree of stability for the cutting edge.
- A large corner radius permits a greater feed rate.
- Use a smaller corner radius if there is a risk of vibration.

When selecting the feed rate for rough turning work, the maximum feed rates given above must not be exceeded in any circumstances. The basic rule is:

$$f_r \text{ Roughing} = 0,5 \times \text{Corner radius}$$

Maximum feed rate for various corner radii

The most frequently used radii for rough machining are between 1.2 - 1.6 mm.

The table is based on the max. recommended feed rate of $\frac{2}{3}$ of the corner radius.

Greater feed rates are possible in the following cases:

- Indexable inserts have a stable cutting edge and a point angle of at least 60°.
- Single-sided indexable inserts.
- Indexable inserts which are used with a setting angle less than 90°.
- Working easily machineable workpiece materials at moderate cutting speeds.

Theoretische maximale Rautiefe (R_{max})

Theoretical maximum roughness height (R_{max})

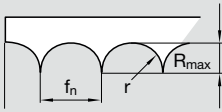

R_{max} = Rautiefe
Roughness height
 r = Eckenradius (mm)
Corner radius (mm)
 f_n = Vorschub (mm/U)
Feed (mm/revolution)

$$R_{max} = \frac{f_n^2}{8r} \cdot 1000 \text{ (}\mu\text{m)}$$

Vorschub Feed:

$$f_n = \sqrt{\frac{R_{max} \times 8r}{1000}}$$

Mittenrauwert (R_a)

Mean roughness figure (R_a)

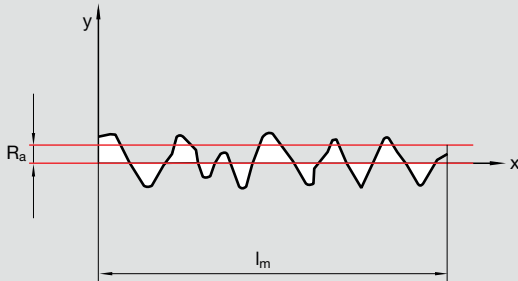

Die Oberflächengüte und Toleranzgenauigkeit wird wesentlich durch das Zusammenspiel von Vorschub und Eckenradius beeinflusst. Weitere Einflussgrößen sind die Stabilität der Aufspannung und der Maschine.

Allgemeine Empfehlung

- Die Oberflächengüte kann durch höhere Schnittgeschwindigkeiten und positive Spanwinkel noch verbessert werden.
- Bei Vibrationsgefahr kleineren Eckenradius wählen.
- Besonders gute Oberflächengüten werden mit unbeschichteten Hartmetallsorten (schärfere Schneidkanten als beschichtete Sorten) erzielt.

The surface quality and accuracy of the tolerance is greatly influenced by the interaction of the feed rate and corner radius. The stability of the clamping system and the machine are other decisive factors.

General recommendation

- The surface quality can be improved by using higher cutting speeds and positive rake angles.
- Use a smaller corner radius if there is a risk of vibration.
- Especially high quality surfaces can be achieved using uncoated hard metals (sharper cutting edges than coated grades).

R _{max}	R _a = CLA = AA		RMS		Rauigkeitswert Value for roughness
	µm	µinch	µm	µinch	
1,6	0,30	11,8	0,33	13,1	
1,8	0,35	13,8	0,39	15,3	
2,0	0,40	15,7	0,44	17,4	N5
2,2	0,44	17,5	0,49	19,4	
2,4	0,49	19,2	0,54	21,3	
2,6	0,53	20,8	0,59	23,1	
2,8	0,58	22,7	0,64	25,2	
3,0	0,63	24,6	0,70	27,3	
3,5	0,71	27,8	0,79	30,9	
4,0	0,80	31,4	0,89	34,8	N6
4,5	0,90	35,2	1,00	39,1	
5,0	0,99	38,8	1,10	43,1	
6,0	1,20	47,2	1,30	52,4	
7,0	1,40	55,1	1,50	61,2	
8,0	1,60	63,0	1,80	70,0	N7
9,0	1,80	71,0	2,00	78,8	
10,0	2,00	79,0	2,20	87,7	
15,0	3,20	126,0	3,10	140,0	N8
20,0	4,40	173,0	4,90	192,0	
25,0	5,80	238,0	6,40	264,0	
27,0	6,30	247,0	7,00	274,0	N9
30,0	7,40	292,0	8,20	324,0	
35,0	8,80	346,0	9,80	384,0	
40,0	10,70	422,0	11,90	468,0	
45,0	12,50	485,0	13,90	538,0	N10

Vorgangsweise:

Umwandlungstabelle für die verschiedenen Messsysteme. Es lässt sich keine rechnerische Beziehung zwischen der Rautiefe R_{max} und dem Wert R_a herstellen.

Aus der Umwandlungstabelle den in Frage kommenden R_{max}-Wert entnehmen. Danach aus dem Diagramm die richtige Kombination von Eckenradius und Vorschub ablesen.

Procedure:

Conversion table for various measurement systems. This cannot be used to calculate a mathematical relationship between the R_{max} roughness height and the figure for R_a.

Look up the appropriate R_{max} value in the conversion table. Then read off the correct combination of corner radius and feed rate.

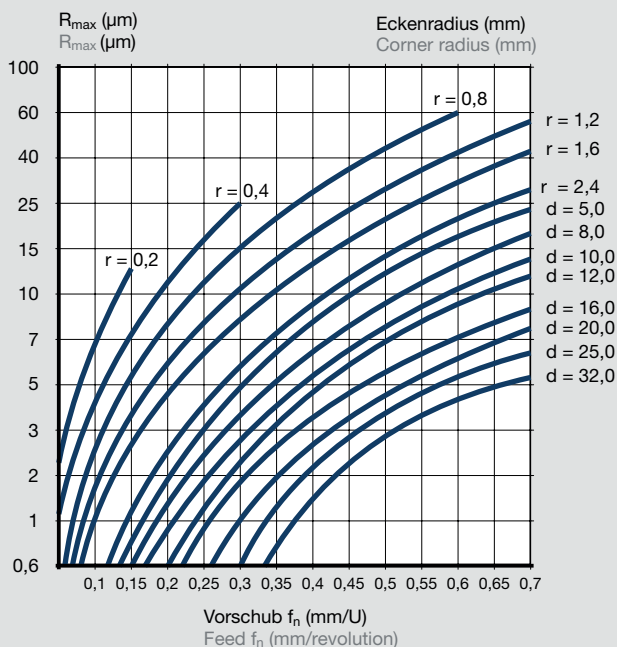

Das Diagramm zeigt theoretische R_{max}-Werte für bestimmte Vorschub-/Eckenradius-Kombinationen.
The diagram shows theoretical R_{max} values for specific feed/corner radius combinations.



Berechnungseinheiten Units		
Kurzbezeichnung Code	Bezeichnung Description	Einheiten Unit
D_m	Bearbeitungsdurchmesser Machining diameter	mm
v_c	Schnittgeschwindigkeit Cutting speed	m/min
n	Anzahl Spindelumdrehungen No. of spindle revolutions	min^{-1} r.p.m.
T_c	Eingriffszeit Working time	min
Q	Zerspanungsvolumen Metal removal volume	cm^3/min
l_m	Bearbeitungslänge Working length	mm
P_c	Netto-Antriebsleistung Net power consumption	kW
$k_{c\ 0,4}$	Spezifische Schnittkraft für Spandicke 0,4 mm Specific cutting force for chip thickness of 0.4 mm	N/mm^2
f_n	Vorschub pro Umdrehung Feed per revolution	mm/U mm/rev
κ_r	Anstellwinkel Approach angle	Grad degrees
R_{\max}	Profiltiefe Profile depth	μm
r_ϵ	Schneidplattenradius Indexable insert corner radius	mm
a_p	Schnitttiefe Cutting depth	mm

Formeln Formulas		
	Schnittgeschwindigkeit (m/min) Cutting speed (m/min)	$v_c = \frac{D_m \cdot \pi \cdot n}{1000}$
	Anzahl Spindelumdrehungen (min^{-1}) No. of spindle revolutions r.p.m.	$n = \frac{v_c \cdot 1000}{D_m \cdot \pi}$
	Zerspanungsvolumen (cm^3/min) Metal removal volume (cm^3/min)	$Q = v_c \cdot a_p \cdot f_n$
	Antriebsleistung (kW) Power consumption (kW)	$P_c = \frac{Q \cdot k_{c\ 0,4}}{60 \cdot 1000} \left[\frac{0,4}{f_n \cdot \sin \kappa_r} \right]^{0,29}$
	Eingriffszeit (min) Working time (min)	$T_c = \frac{l_m}{f_n \cdot n}$
	Profiltiefe (μm) Profile depth (μm)	$R_{\max} = \frac{f_n^2}{r_\epsilon} \cdot 125$

Abhilfe Option	Problem											
	Extremer Freiflächenverschleiß Wear of free areas	Extremer Kolkverschleiß Extreme crater wear	Aufbauschneidenbildung Formation of built-up edge	Schneidkantenausbrüche Chips in cutting edge	Kerbverschleiß Notch sensibility	Plattenbruch Broken indexable insert	Wärmerisse Heat cracks	Plastische Verformung Plastic deformation	Unterbrochener Schnitt Interrupted cut	Schlechte Werkstückoberfläche Poor workpiece surface	Band-/Wirrspan (nicht angelaufen) Band/snarl chips (not coloured)	Zu enge Spanform (blau angelaufen) Chip shape too narrow (blueing)
HM-Verschleißfestigkeit T/C wear resistance	↑				↑			↑				
HM-Zähigkeit T/C roughness				↑		↑	↑		↑			
Schnittgeschwindigkeit Cutting speed	↓	↓	↑		↓			↓	↑	↑		
Vorschub Feed	↔	↓	↓					↓	↓	↓	↑	↓
Schnitttiefe Depth of cut					↔				↑		↔	↔
Spanwinkel Chip angle		↑	↑	↓		↓			↔			
Spanformgeometrie Chip breaker geometry				↔		↔					↔	↔
Zustand der Schneidkante Condition of cutting edge				↔					↔			
Platten-Eckenradius Corner radius						↑			↑	↑		
Anstellwinkel Approach angle				↓								
Stabilität Stability				↑								
Kühlung Cooling		↑	↑				↑	↑		↑		
<p> ↑ erhöhen, vergrößern ↓ vermindern, verkleinern ↔ optimieren, kontrollieren increase reduce optimize </p>												

Werkstoffgruppe Material group	Werkstoff Material		Brinell Härte Brinell hardness HB	Schnittgeschwindigkeit Cutting speed v_c (m/min)		
				LCP15T		
				f = mm/U rev		
				0,4–0,8	0,25–0,4	0,05–0,25
						
P	Unlegierter Stahl ¹⁾ Unalloyed steel ¹⁾	ca. 0,15 %C geglüht ≈ 0,15 %C annealed	125	140 – 200	230 – 300	290 – 360
		ca. 0,45 %C geglüht ≈ 0,45 %C annealed	190	110 – 180	180 – 260	250 – 320
		ca. 0,45 %C vergütet ≈ 0,45 %C hardened and temp.	250	90 – 180	110 – 180	140 – 210
		ca. 0,75 %C geglüht ≈ 0,75 %C annealed	270	120 – 180	170 – 240	230 – 300
		ca. 0,75 %C vergütet ≈ 0,75 %C hardened and temp.	300	130 – 150	80 – 150	140 – 210
	Niedrig legierter Stahl ¹⁾ Low-alloy steel ¹⁾	geglüht annealed	180	100 – 170	150 – 220	220 – 300
		vergütet hardened and temp.	275	100 – 150	110 – 180	140 – 210
		vergütet hardened and temp.	300	100 – 140	100 – 170	130 – 200
		vergütet hardened and temp.	350	100–140	80 – 150	110 – 180
	Hochlegierter Stahl und hochlegierter Werkzeugstahl ¹⁾ High-alloy steel and high alloy tool steel ¹⁾	geglüht annealed	200	100 – 180	80 – 220	180 – 260
gehärtet und angelassen hardened and temp.		325	100 – 160	80 – 140	100 – 170	
Nichtrostender Stahl ¹⁾ Stainless steel ¹⁾	ferritisch/martensitisch geglüht ferritic/martensitic annealed	200	100–170	130 – 200	180 – 260	
	martensitisch vergütet martensitic hardened and temp.	240	100 – 140	80 – 150	150 – 210	
K	Grauguss Grey cast iron	perlitisches/ferritisch perlitic/ferritic	180	100 – 180	170 – 240	250 – 320
		perlitisches (martensitisch) perlitic (martensitic)	260	90 – 120	80 – 150	110 – 180
	Gusseisen mit Kugelgraphit Nodular graphite cast iron	ferritisch ferritic	160	100 – 150	110 – 180	140 – 210
		perlitisches perlitic	250	90 – 140	90 – 160	110 – 180
	Temperguss Malleable cast iron	ferritisch ferritic	130	90 – 140	120 – 190	150 – 210
perlitisches perlitic		230	90 – 120	100 – 150	110 – 180	

¹⁾ und Stahlguss
and cast steel

 Trockenbearbeitung
Dry machining

 Nassbearbeitung
Wet machining







Werkstoffgruppe Material group	Werkstoff Material	Brinell Härte Brinell hardness HB	Schnittgeschwindigkeit Cutting speed v_c (m/min)			
			LCP25T			
			f = mm/U rev			
			0,4 – 0,8	0,25 – 0,4	0,05 – 0,25	
P	Unlegierter Stahl ¹⁾ Unalloyed steel ¹⁾	ca. 0,15 %C geglüht ≈ 0,15 %C annealed	125	120 – 190	170 – 250	170 – 250
		ca. 0,45 %C geglüht ≈ 0,45 %C annealed	190	100 – 180	150 – 200	150 – 220
		ca. 0,45 %C vergütet ≈ 0,45 %C hardened and temp.	250	80 – 150	100 – 170	120 – 200
		ca. 0,75 %C geglüht ≈ 0,75 %C annealed	270	100 – 170	80 – 140	140 – 200
		ca. 0,75 %C vergütet ≈ 0,75 %C hardened and temp.	300	70 – 140	100 – 160	100 – 170
		Niedrig legierter Stahl ¹⁾ Low-alloy steel ¹⁾	geglüht annealed	180	90 – 160	140 – 200
	Hochlegierter Stahl und hochlegierter Werkzeugstahl ¹⁾ High-alloy steel and high alloy tool steel ¹⁾	vergütet hardened and temp.	275	90 – 140	100 – 160	100 – 180
		vergütet hardened and temp.	300	85 – 130	100 – 150	100 – 170
		vergütet hardened and temp.	350	80 – 120	80 – 140	90 – 170
		geglüht annealed	200	90 – 150	80 – 170	130 – 170
	Nichtrostender Stahl ¹⁾ Stainless steel ¹⁾	gehärtet und angelassen hardened and temp.	325	50 – 110	70 – 130	80 – 130
		ferritisch/martensitisch geglüht ferritic/martensitic annealed	200	90 – 140	120 – 180	140 – 180
M	Nichtrostender Stahl ¹⁾ Stainless steel ¹⁾	martensitisch vergütet martensitic hardened and temp.	240	85 – 120	80 – 140	100 – 140
		austenitisch ²⁾ , abgeschreckt austenitic ²⁾ , quenched	180	90 – 110	100 – 130	100 – 130

¹⁾ und Stahlguss
and cast steel

²⁾ und austenitische/ferritische
and austenitic/ferritic

 Trockenbearbeitung
Dry machining

 Nassbearbeitung
Wet machining

Werkstoffgruppe Material group	Werkstoff Material		Brinell Härte Brinell hardness HB	Schnittgeschwindigkeit Cutting speed v_c (m/min)					
				LC240F					
				f = mm/U rev					
				0,4–0,8	0,25–0,4	0,05–0,25			
									
P	Unlegierter Stahl ¹⁾ Unalloyed steel ¹⁾	ca. 0,15 %C geglüht ≈ 0,15 %C annealed	125	60 – 100	70 – 110	90 – 170			
		ca. 0,45 %C geglüht ≈ 0,45 %C annealed	190	60 – 100	70 – 110	90 – 170			
		ca. 0,45 %C vergütet ≈ 0,45 %C hardened and temp.	250	60 – 100	70 – 110	90 – 170			
		ca. 0,75 %C geglüht ≈ 0,75 %C annealed	270	60 – 100	70 – 110	90 – 170			
		ca. 0,75 %C vergütet ≈ 0,75 %C hardened and temp.	300	60 – 100	70 – 110	90 – 170			
	Niedrig legierter Stahl ¹⁾ Low-alloy steel ¹⁾	geglüht annealed	180	60 – 100	70 – 110	90 – 170			
		vergütet hardened and temp.	275	70 – 110	70 – 110	90 – 170			
			300	60 – 100	70 – 110	90 – 170			
			350	55 – 80	70 – 110	90 – 170			
	Hochlegierter Stahl und hochlegierter Werkzeugstahl ¹⁾ High-alloy steel and high alloy tool steel ¹⁾	geglüht annealed	200	80 – 110	70 – 110	90 – 170			
gehärtet und angelassen hardened and temp.		325	60 – 90	70 – 110	90 – 170				
Nichtrostender Stahl ¹⁾ Stainless steel ¹⁾	ferritisch/martensitisch geglüht ferritic/martensitic annealed	200	90 – 130	70 – 110	90 – 170				
	martensitisch vergütet martensitic hardened and temp.	240	70 – 110	70 – 110	90 – 170				
M	Nichtrostender Stahl ¹⁾ Stainless steel ¹⁾	austenitisch ²⁾ , abgeschreckt austenitic ²⁾ , quenched	180	70 – 100	90 – 140	110 – 170			

¹⁾ und Stahlguss
and cast steel

²⁾ und austenitische/ferritische
and austenitic/ferritic

 Trockenbearbeitung
Dry machining

 Nassbearbeitung
Wet machining

Werkstoffgruppe Material group	Werkstoff Material	Werkstoff Material	LCM20T													
			Negative Wendepplatten Negative indexable inserts					Positive Wendepplatten Positive indexable inserts								
			ISO-P-System					ISO-S-System								
			Brinell Härte HB Brinell hardness HB	Geometrie Geometry	Eckenradius Corner radius	Empfohlene a_p (mm) Recommended a_p (mm)	Empfohlene f_n (mm/U) Recommended f_n (mm/rev)	Schnittgeschwindigkeit v_c (m/min) Cutting speed v_c (m/min)	Geometrie Geometry	Eckenradius Corner radius	Empfohlene a_p (mm) Recommended a_p (mm)	Empfohlene f_n (mm/U) Recommended f_n (mm/rev)	Schnittgeschwindigkeit v_c (m/min) Cutting speed v_c (m/min)			
M	Ferritisch Ferritic	1.4000, 1.4002, 1.4003, 1.4006, 1.4016, 1.4104, 1.4113, 1.4313, 1.4742, 1.4762	180	MM	08 12	2 3	0,20 0,30	180 – 230 180 – 230	MM	04 08	1 2	0,15 0,25	180 – 230 180 – 230			
		Martensitisch Martensitic	1.4006, 1.4014, 1.4021, 1.4024, 1.4027, 1.4028, 1.4031, 1.4034, 1.4057, 1.4122, 1.4724	320	MM	08 12	2 3	0,20 0,30	180 – 230 180 – 230	MM	04 08	1 2	0,15 0,25	180 – 230 180 – 230		
			Austenitisch Austenitic	1.4300, 1.4301, 1.4303, 1.4305, 1.4306, 1.4308, 1.4310, 1.4311	180	MM	08 12	2 3	0,2 0,3	150 – 200 150 – 200	MM	04 08	1 2	0,15 0,20	150 – 200 150 – 200	
					1.4321, 1.4401, 1.4404, 1.4406, 1.4428, 1.4435, 1.4436, 1.4438, 1.4449 1.4571	180	MM	08 12	2 3	0,2 0,3	150 – 200 150 – 200	MM	04 08	0,4 0,8	1 2	150 – 200 150 – 200

Die angegebenen Schnittdatenrichtwerte sind Empfehlungen für Anwendungen mit Kühlschmierstoff.
Bei Trockenbearbeitung reduzieren Sie die Schnittgeschwindigkeit v_c um ca. 20 %.
The above recommendations are given for wet machining. For dry machining the recommended values for the cutting speed have to be reduced by approx. 20 %.

Werkstoffgruppe Material group			BCM25T										
			Negative Wendepplatten Negative indexable inserts						Positive Wendepplatten Positive indexable inserts				
			ISO-P-System						ISO-S-System				
			Brinell Härte HB Brinell hardness HB	Geometrie Geometry	Eckenradius Corner radius	Empfohlene a_p (mm) Recommended a_p (mm)	Empfohlene f_n (mm/U) Recommended f_n (mm/rev)	Schnittgeschwindigkeit v_c (m/min) Cutting speed v_c (m/min)	Geometrie Geometry	Eckenradius Corner radius	Empfohlene a_p (mm) Recommended a_p (mm)	Empfohlene f_n (mm/U) Recommended f_n (mm/rev)	Schnittgeschwindigkeit v_c (m/min) Cutting speed v_c (m/min)
M	Ferritisch Ferritic 1.4000, 1.4002, 1.4003, 1.4006, 1.4016, 1.4104, 1.4113, 1.4313, 1.4742, 1.4762	180	MM	08	2	0,2	130 - 200	MM	04	1	0,15	130 - 200	
				12	3	0,3	130 - 200						
				16	3,5	0,3	130 - 200						
			BFMS	04	1	0,15	130 - 200						
				08	2,5	0,25	130 - 200						
				12	3	0,3	130 - 200						
		BMS	08	2	0,2	130 - 200							
			12	3	0,3	130 - 200							
		Martensitisch Martensitic 1.4006, 1.4014, 1.4021, 1.4024, 1.4027, 1.4028, 1.4031, 1.4034, 1.4057, 1.4122, 1.4724	320	MM	08	2	0,2	130 - 200	MM	04	1	0,15	130 - 200
					12	3	0,3	130 - 200					
					16	3,5	0,3	130 - 200					
	BFMS			04	1	0,15	130 - 200						
				08	2,5	0,25	130 - 200						
				12	3	0,3	130 - 200						
	BMS		08	2	0,2	130 - 200							
			12	3	0,3	130 - 200							
	Austenitisch Austenitic 1.4300, 1.4301, 1.4303, 1.4305, 1.4306, 1.4308, 1.4310, 1.4311 1.4321, 1.4401, 1.4404, 1.4406, 1.4428, 1.4435, 1.4436, 1.4438, 1.4449 1.4571		180	MM	08	2	0,2	100 - 180	MM	04	1	0,15	100 - 180
					12	3	0,3	100 - 180					
					16	3,5	0,3	100 - 180					
		BFMS		04	1	0,15	100 - 180						
				08	2,5	0,25	100 - 180						
				12	3	0,3	100 - 180						
BMS		08	2	0,2	100 - 180								
		12	3	0,3	100 - 180								
180		MM	08	2	0,2	100 - 180	MM	04	1	0,15	100 - 180		
			12	3	0,3	100 - 180							
			16	3,5	0,3	100 - 180							
	BFMS	04	1	0,15	100 - 180								
		08	2,5	0,25	100 - 180								
		12	3	0,3	100 - 180								
BMS	08	2	0,2	100 - 180									
	12	3	0,3	100 - 180									

Die angegebenen Schnittdatenrichtwerte sind Empfehlungen für Anwendungen mit Kühlschmierstoff.

Bei Trockenbearbeitung reduzieren Sie die Schnittgeschwindigkeit v_c um ca. 20 %.

The above recommendations are given for wet machining. For dry machining the recommended values for the cutting speed have to be reduced by approx. 20 %.

Werkstoffgruppe Material group			BCM40T																						
			Negative Wendepplatten Negative indexable inserts					Positive Wendepplatten Positive indexable inserts																	
			ISO-P-System					ISO-S-System																	
			Brinell Härte HB Brinell hardness HB	Geometrie Geometry	Eckenradius Corner radius	Empfohlene a_p (mm) Recommended a_p (mm)	Empfohlene f_n (mm/U) Recommended f_n (mm/rev)	Schnittgeschwindigkeit v_c (m/min) Cutting speed v_c (m/min)	Geometrie Geometry	Eckenradius Corner radius	Empfohlene a_p (mm) Recommended a_p (mm)	Empfohlene f_n (mm/U) Recommended f_n (mm/rev)	Schnittgeschwindigkeit v_c (m/min) Cutting speed v_c (m/min)												
M	Ferritisch Ferritic	1.4000, 1.4002, 1.4003, 1.4006, 1.4016, 1.4104, 1.4113, 1.4313, 1.4742, 1.4762	180	MM	08	2	0,2	100 - 180																	
					12	3	0,3	100 - 180																	
					16	3,5	0,3	100 - 180																	
					BMRS	12	4	0,45	100 - 180																
						16	5	0,5	100 - 180																
	Martensitisch Martensitic	1.4006, 1.4014, 1.4021, 1.4024, 1.4027, 1.4028, 1.4031, 1.4034, 1.4057, 1.4122, 1.4724	320	MM	08	2	0,2	100 - 180																	
					12	3	0,3	100 - 180																	
					16	3,5	0,3	100 - 180																	
					BMRS	12	4	0,45	100 - 180																
						16	5	0,5	100 - 180																
	Austenitisch Austenitic	1.4300, 1.4301, 1.4303, 1.4305, 1.4306, 1.4308, 1.4310, 1.4311	180	MM	08	2	0,2	70 - 150																	
					12	3	0,3	70 - 150																	
					16	3,5	0,3	70 - 150																	
					BMRS	12	4	0,45	100 - 180																
						16	5	0,5	100 - 180																
	1.4321, 1.4401, 1.4404, 1.4406, 1.4428, 1.4435, 1.4436, 1.4438, 1.4449 1.4571	180	MM	08	2	0,2	70 - 150																		
				12	3	0,3	70 - 150																		
				16	3,5	0,3	70 - 150																		
				BMRS	12	4	0,45	100 - 180																	
					16	5	0,5	100 - 180																	

Die angegebenen Schnittdatenrichtwerte sind Empfehlungen für Anwendungen mit Kühlschmierstoff.
Bei Trockenbearbeitung reduzieren Sie die Schnittgeschwindigkeit v_c um ca. 20 %.
The above recommendations are given for wet machining. For dry machining the recommended values for the cutting speed have to be reduced by approx. 20 %.

Werkstoffgruppe Material group		Werkstoff Material		LC435D																					
				Negative Wendepplatten Negative indexable inserts ISO-P-System						Positive Wendepplatten Positive indexable inserts ISO-S-System															
				Brinell Härte HB Brinell hardness HB	Geometrie Geometry	Eckenradius Corner radius	Empfohlene a_p (mm) Recommended a_p (mm)	Empfohlene f_n (mm/U) Recommended f_n (mm/rev)	Schnittgeschwindigkeit v_c (m/min) Cutting speed v_c (m/min)	Geometrie Geometry	Eckenradius Corner radius	Empfohlene a_p (mm) Recommended a_p (mm)	Empfohlene f_n (mm/U) Recommended f_n (mm/rev)	Schnittgeschwindigkeit v_c (m/min) Cutting speed v_c (m/min)											
M	Ferritisch Ferritic	1.4000, 1.4002, 1.4003, 1.4006, 1.4016, 1.4104, 1.4113, 1.4313, 1.4742, 1.4762	180	BFMS	04	0,5	0,15	150 – 180																	
					08	1	0,20	150 – 180																	
					12	2	0,25	120 – 180																	
				BMS	08	2	0,25	150 – 180	BSMS	04	0,4	0,15	120 – 180												
					12	3	0,30	150 – 180		08	1	0,20	140 – 180												
					16	4	0,35	120 – 180																	
		Martensitisch Martensitic	1.4006, 1.4014, 1.4021, 1.4024, 1.4027, 1.4028, 1.4031, 1.4034, 1.4057, 1.4122, 1.4724	320	BFMS	04	0,5	0,15	140 – 180																
						08	1	0,20	120 – 180																
						12	2	0,25	110 – 160																
					BMS	08	2	0,25	120 – 180	BSMS	04	0,4	0,15	140 – 180											
						12	3	0,30	110 – 160		08	1	0,20	120 – 180											
						16	4	0,35	100 – 140																
	Austenitisch Austenitic	1.4300, 1.4301, 1.4303, 1.4305, 1.4306, 1.4308, 1.4310, 1.4311	180	BFMS	04	0,5	0,15	150 – 180																	
					08	1	0,20	150 – 180																	
					12	2	0,25	120 – 180																	
				BMS	08	2	0,25	120 – 180	BSMS	04	0,4	0,15	120 – 150												
					12	3	0,30	120 – 180		08	1	0,20	150 – 180												
					16	4	0,35	140 – 180																	
		1.4321, 1.4401, 1.4404, 1.4406, 1.4428, 1.4435, 1.4436, 1.4438, 1.4449	180	BFMS	04	0,5	0,15	150 – 180																	
					08	1	0,20	140 – 180																	
					12	2	0,25	130 – 180																	
				BMS	08	2	0,25	140 – 180	BSMS	04	0,4	0,15	150 – 180												
					12	3	0,30	130 – 180		08	1	0,20	120 – 180												
					16	4	0,35	120 – 160																	
BMRS	08	3	0,35	150 – 180																					
	12	4	0,45	140 – 180																					
	16	5	0,50	120 – 160																					

Die angegebenen Schnittdatenrichtwerte sind Empfehlungen für Anwendungen mit Kühlschmierstoff.
Bei Trockenbearbeitung reduzieren Sie die Schnittgeschwindigkeit v_c um ca. 20 %.
The above recommendations are given for wet machining. For dry machining the recommended values for the cutting speed have to be reduced by approx. 20 %.

Werkstoffgruppe Material group	Werkstoff Material		Brinell Härte Brinell hardness HB	Schnittgeschwindigkeit Cutting speed v_c (m/min)		
				LC610H und and LC620H		
				f = mm/U rev		
				0,4–0,8	0,25–0,4	0,05–0,25
K	Grauguss Grey cast iron	perlitisch/ferritisch perlitic/ferritic	180	210 – 300	300 – 450	350 – 500
		perlitisch (martensitisch) perlitic (martensitic)	260	140 – 200	170 – 240	190 – 270
	Gusseisen mit Kugelgraphit Nodular graphite cast iron	ferritisch ferritic	160	150 – 210	180 – 260	210 – 300
		perlitisch perlitic	250	110 – 160	130 – 190	150 – 200
	Temperguss Malleable cast iron	ferritisch ferritic	130	200 – 280	220 – 300	240 – 330
		perlitisch perlitic	230	100 – 150	140 – 220	170 – 240

 Nassbearbeitung
Wet machining

Schnittwertempfehlungen für Drehen LCM45T

Turning data recommendations for LCM45T

Dreh-Bohr-Werkzeug Pentatec®

Turning-drilling-tool Pentatec®



Werkstoffgruppe Material group	Gliederung der Werkstoff-Hauptgruppen und Kennbuchstaben Main workpiece material groups and their characteristic letters		Brinell Härte Brinell hardness HB	Drehen und Bohren Turning and drilling v_c m/min	
	Werkstückstoff			LCM45T	
P	Unlegierter Stahl ¹⁾ Unalloyed steel ¹⁾	ca 0,15%C geglüht ≈0,15%C annealed	125	120 - 250	Vorschubwerte Pentatec siehe Seite 130 - 131 Feed value Pentatec see page 130 - 131
		ca 0,45%C geglüht ≈0,45%C annealed	190	100 - 200	
		ca 0,45%C vergütet ≈0,45%C hardened and temp.	250	70 - 180	
		ca 0,75%C geglüht ≈0,75%C annealed	270	70 - 180	
		ca 0,75%C vergütet ≈0,75%C hardened and temp.	300	50 - 150	
	Niedrig legierter Stahl ¹⁾ Low-alloy steel ¹⁾	geglüht annealed	180	80 - 200	
		vergütet hardened and temp.	275	70 - 180	
		vergütet hardened and temp.	300	100 - 185	
		vergütet hardened and temp.	350	70 - 150	
	Hochlegierter Stahl und hochleg. Werkzeugstahl High-alloy steel and high-alloy tool steel ¹⁾	geglüht annealed	200	70 - 180	
		gehärtet und angelassen hardened and temp.	325	50 - 120	
		ferritisch / martensitisch geglüht ferritic / martensitic annealed	200	70 - 150	
martensitisch vergütet martensitic hardened and temp.		240	70 - 120		
M	Nichtrostender Stahl ¹⁾ Stainless steel ¹⁾	austenitisch ²⁾ , abgeschreckt austenitic ²⁾ , quenched	180	50 - 150	

¹⁾ und Stahlguss

²⁾ und austenitische / ferritische

¹⁾ and cast steel

²⁾ and austenitic / ferritic



Werkstoffgruppe Material group	Werkstoff Material		Brinell Härte Brinell hardness HB	Schnittgeschwindigkeit Cutting speed v_c (m/min)		
				LC610T		
				f = mm/U rev		
				0,4–0,8	0,25–0,4	0,05–0,25
						
M	Nichtrostender Stahl ¹⁾ Stainless steel ¹⁾	austenitisch ²⁾ , abgeschreckt austenitic ²⁾ , quenched				120 – 300
	K	Grauguss Grey cast iron	perlitisch/ferritisch perlitic/ferritic	180		
perlitisch (martensitisch) perlitic (martensitic)			180			
Gusseisen mit Kugelgraphit Nodular graphite cast iron		ferritisch ferritic	260			70 – 200
		perlitisch perlitic	160			
Temperguss Malleable cast iron		ferritisch ferritic	250			80 – 220
		perlitisch perlitic	130			
N	Aluminium-Knetlegierungen Aluminium wrought alloys	nicht aushärtbar unhardenable	230	500 – 2000	600 – 2500	700 – 3000
		aushärtbar, ausgehärtet hardenable, hardened	60	200 – 1000	300 – 1500	400 – 2000
	Aluminium-Gusslegierungen Aluminium cast alloys	ca. 12 % Si. nicht aushärtbar ca. 12 % Si. unhardenable	100	400 – 800	500 – 1200	600 – 1500
		ca. 12 % Si. aushärtbar, ausgehärtet ca. 12 % Si. hardenable, hardened	75	300 – 600	400 – 900	500 – 1200
		> 12 % Si. nicht aushärtbar > 12 % Si. unhardenable	90	200 – 600	300 – 800	400 – 1000
	Kupfer und Kupferlegierungen (Bronze/Messing) Copper and copper alloys (Bronze/Brass)	Automatenlegierung Pb > 1 % Free cutting alloys Pb > 1 %	130	250 – 400	250 – 500	450 – 650
		Messing, Rotguss Brass, Red bronze	110	250 – 600	250 – 800	450 – 1000
		Bronze, bleifreies Kupfer und Elektrolytkupfer Bronze, non leaded copper and electrolytic copper	90 100	150 – 250	180 – 300	200 – 400
	Nichtmetallische Werkstoffe Nonmetallic materials	Duroplaste Duroplastics		60 – 70	80 – 100	90 – 120
		Faserverstärkte Kunststoffe Fibre reinforced plastics				
		Hartgummi Hard rubber				

¹⁾ und Stahlguss
and cast steel

²⁾ und austenitische/ferritische
and austenitic/ferritic



Nassbearbeitung
Wet machining

Werkstoffgruppe Material group	Werkstoff Material		Brinell Härte Brinell hardness HB	Schnittgeschwindigkeit Cutting speed
				v_c (m/min)
				LW610 und and LW611
				f = mm/U rev
				0,1-0,4
				 
K	Grauguss Grey cast iron	perlitisch/ferritisch perlitic/ferritic	180	150 – 250
		perlitisch (martensitisch) perlitic (martensitic)	260	100 – 150
	Gusseisen mit Kugelgraphit Nodular graphite cast iron	ferritisch ferritic	160	130 – 180
		perlitisch perlitic	250	100 – 150
	Temperguss Malleable cast iron	ferritisch ferritic	130	120 – 180
		perlitisch perlitic	230	100 – 160
N	Aluminium-Knetlegierungen Aluminium wrought alloys	nicht aushärtbar unhardenable	60	400 – 2400
		aushärtbar, ausgehärtet hardenable, hardened	100	160 – 1600
	Aluminium-Gusslegierungen Aluminium cast alloys	ca. 12 % Si. nicht aushärtbar ca. 12 % Si. unhardenable	75	320 – 1200
		ca. 12 % Si. aushärtbar, ausgehärtet ca. 12 % Si. hardenable, hardened	90	240 – 950
		> 12 % Si. nicht aushärtbar > 12 % Si. unhardenable	130	160 – 800
	Kupfer und Kupferlegierungen (Bronze/Messing) Copper and copper alloys (Bronze/Brass)	Automatenlegierung Pb > 1 % Free cutting alloys Pb > 1 %	110	200 – 520
		Messing, Rotguss Brass, Red bronze	90	200 – 800
		Bronze, bleifreies Kupfer und Elektrolytkupfer Bronze, non leaded copper and electrolytic copper	100	120 – 320
	Nichtmetallische Werkstoffe Nonmetallic materials	Duroplaste Duroplastics		
		Faserverstärkte Kunststoffe Fibre reinforced plastics		
Hartgummi Hard rubber				

 Trockenbearbeitung
Dry machining

 Nassbearbeitung
Wet machining

Werkstoffgruppe Material group	Werkstoff Material	Brinell Härte Brinell hardness HB	Schnittgeschwindigkeit Cutting speed v_c (m/min)	Vorschub Feed f mm/U rev
			LC415X	
				
P	Automatenstahl Machining steel	125 - 300	100 - 220	0,01 - 0,15
	Stahl Steel < 600 N/mm ²	180 - 380	100 - 180	0,01 - 0,20
	Stahl Steel < 800 N/mm ²	200 - 350	60 - 130	0,01 - 0,15
M	Nichtrostender Stahl Stainless steel	180 - 300	60 - 140	0,01 - 0,20
N	Aluminium Aluminium	30 - 130	200 - 800	0,01 - 0,30
	Bronze, Messing, Kupfer Bronze, Brass, Copper	100 - 500	100 - 500	0,01 - 0,30
S	Titan Titanium	180 - 400	40 - 90	0,01 - 0,15
		180 - 400	30 - 70	0,2 - 0,45

Schnittwertempfehlungen für Drehen LC415Z und BCS20T
Cutting data recommendations for LC415Z and BCS20T

Werkstoffgruppe Material group	Werkstoff Material	Brinell Härte Brinell hardness HB	Schnittgeschwindigkeit Cutting speed v_c (m/min)		
			LC415Z / BCS20T		
			f = mm/U rev 0,15 - 0,5		
					
M	Nichtrostender Stahl ¹⁾ Stainless steel ¹⁾	austenitisch ²⁾ , abgeschreckt austenitic ²⁾ , quenched	180	80 - 180	
S	Warmfeste Legierungen Heat resistant alloys	Fe-Basis Fe-based	geglüht annealed	200	40 - 100
			ausgehärtet hardened	280	30 - 70
		Ni- oder Co-Basis Ni- or Co-based	geglüht annealed	250	50 - 85
			ausgehärtet hardened	350	20 - 50
			gegossen cast	320	30 - 50

Schnittwertempfehlungen für Drehen BCS10T
Cutting data recommendations for BCS10T

Werkstoffgruppe Material group	Werkstoff Material	Brinell Härte Brinell hardness HB	Schnittgeschwindigkeit Cutting speed v_c (m/min)	
			BCS10T	
			f = mm/U rev 0,2 - 0,45	
S	Warmfeste Legierungen Heat resistant alloys	Titan und Titan-Legierungen Titanium and titanium alloys	150 - 450	30 - 70

¹⁾ und Stahlguss
and cast steel

²⁾ und austenitische/ferritische
and austenitic/ferritic

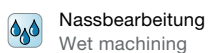

BOEHLERIT

Pentatec®

Pentatec®

Das universellste Dreh-Bohr-Werkzeug
Kostenreduktion auf allen Hauptwerkstoffen

The most universal turning-drilling-tool
Cost reduction on all main materials



121	Dreh-Bohr-Werkzeug Pentatec® Turning-drilling-tool Pentatec®
123	Fünf Bearbeitungsoperationen, ein Werkzeug Five machining operations, one tool
124	Konstruktionsmerkmale und weitere Anwendungsmöglichkeiten Additional features and application possibilities
126	Bezeichnungssystem Pentatec® Designation system Pentatec®
127	Pentatec® Halter Pentatec® holders
128	Wendeschneidplatten Indexable inserts
129	Pentatec® Mini / Pentatec® Adapter Pentatec® Mini / Pentatec® Adapter
129	Schneidstoffsorten, Übersicht Grade designation, overview
130	Schnittparameter Cutting parameters
132	Schnittwertempfehlungen, Dreh-Bohr-Werkzeug Pentatec® Cutting data recommendations, turning-drilling-tool Pentatec®
133	Bearbeitungsbeispiele Machining examples



Fünf Bearbeitungsoperationen, ein Werkzeug
 Das universelle Dreh-Bohr-Werkzeug ersetzt bis zu fünf ISO-Werkzeuge und reduziert die Bearbeitungszeiten um bis zu 30 % durch die Einsparung von Werkzeugwechselzeiten und Werkzeugleerfahrten.

Five machining operations, one tool
 The universal turning-drilling-tool substitutes up to 5 ISO-tools and reduces machining times up to 30 % through saving of tool changing times and unnecessary tool movements.

Nebenschneide einsetzbar
Secondary cutting edge can be used

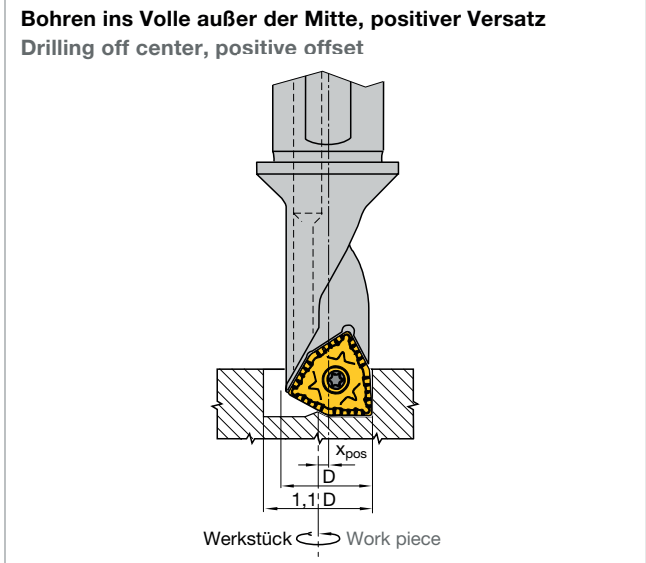

X_{pos} : Versatz aus der Mitte positiv
Offset off center, positive
D: Nenndurchmesser Werkzeug
Nominal tool diameter

Stahl
Steel $X_{pos} = \frac{(1,1 \times D) - D}{2}$

Aluminium
Aluminium $X_{pos} = \frac{(1,5 \times D) - D}{2}$

Werkzeug Tool	D	Stahl Steel		Aluminium Aluminium	
		D_{max}	x_{pos}	D_{max}	x_{pos}
2,25D/1,50D					
PTR/L 08 -x,xxD- 04	08H13	8,8	0,40	12,0	2,00
PTR/L 10 -x,xxD- 05	10H13	11,0	0,50	15,0	2,50
PTR/L 11 -x,xxD- 06	11H13	12,1	0,55	16,5	2,75
PTR/L 15 -x,xxD- 07	15H13	16,5	0,75	22,5	3,75
PTR/L 18 -x,xxD- 09	18H13	19,8	0,90	27,0	4,50
PTR/L 20 -x,xxD- 10	20H13	22,0	1,00	30,0	5,00
PTR/L 26 -x,xxD- 13	26H13	28,6	1,30	39,0	6,50



X_{neg} : Versatz aus der Mitte negativ
Offset off center, negative
D: Nenndurchmesser Werkzeug
Nominal tool diameter

$$X_{neg} = \frac{D_{min} - D}{2}$$

Werkzeug Tool	D	D_{min}	x_{neg}
2,25D/1,50D			
PTR/L 08 -x,xxD- 04	08H13	7,8	0,10
PTR/L 10 -x,xxD- 05	10H13	9,8	0,10
PTR/L 11 -x,xxD- 06	11H13	10,8	0,10
PTR/L 15 -x,xxD- 07	15H13	14,7	0,15
PTR/L 18 -x,xxD- 09	18H13	17,7	0,15
PTR/L 20 -x,xxD- 10	20H13	19,7	0,15
PTR/L 26 -x,xxD- 13	26H13	25,7	0,15

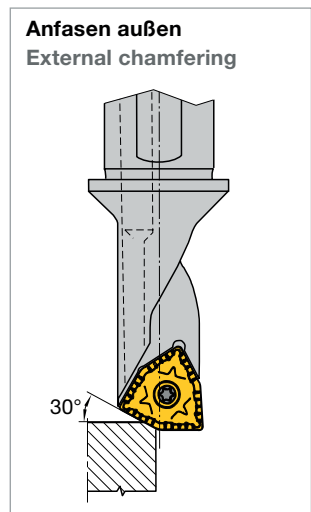
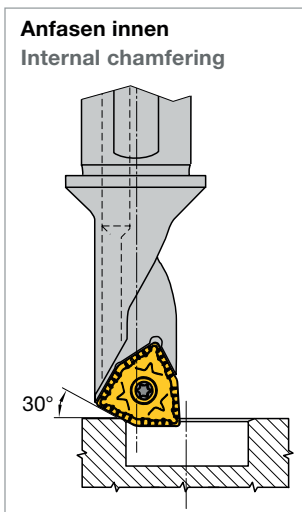

Senkbohrung mit Pentatec®-Werkzeugen
Core drilling with Pentatec®-tools

Die Durchmesserreihe der Pentatec®-Werkzeuge ist so ausgelegt, dass damit Senkbohrungen nach DIN 74 Form H3, J3 und K3 in einem Arbeitsgang produziert werden können.
 The diameters of the Pentatec®-tools are designed to produce counter-bores according to DIN 74 forms H3, J3 and K3 in one operation.

- | | | |
|--------------|--|--|
| Form H3 für: | Zylinderschrauben nach DIN 84 und DIN 7984
Gewindeschneidschrauben nach DIN 7513 Form B
Gewindefurchende Schrauben nach DIN 7500 Teil 1 Form A | } mit Federring nach DIN 7980 |
| Form J3 für: | Zylinderschrauben nach DIN 6912
(niedriger Kopf, Schlüsselführung) | |
| Form K3 für: | Zylinderschrauben nach DIN 912 | |
| Form H3 für: | socket head cap screws according to DIN 84 and DIN 7984
cheese-head screws according to DIN 7513 form B
cheese-head screws according to DIN 7500 part 1 form A | } with lock washer according to DIN 7980 |
| Form J3 für: | socket head cap screws according to DIN 6912
(low screw head, key guide) | |
| Form K3 für: | socket head cap screws according to DIN 912 | |

Werkzeug Tool 2,25D/1,50D	Gewinde- Nenn Durchmesser Thread nominal diameter	D	H13
PTR/L 08 -x,xxD- 04	M 4	8	0/+0,220
PTR/L 10 -x,xxD- 05	M 5	10	0/+0,220
PTR/L 11 -x,xxD- 06	M 6	11	0/+0,270
PTR/L 15 -x,xxD- 07	M 8	15	0/+0,270
PTR/L 18 -x,xxD- 09	M 10	18	0/+0,330
PTR/L 20 -x,xxD- 10	M 12	20	0/+0,330
PTR/L 26 -x,xxD- 13	M 16	26	0/+0,330

Große Aufnahmedurchmesser und Plananlage
Large mounting diameter and location face

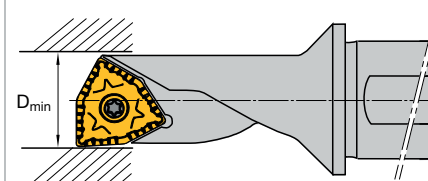
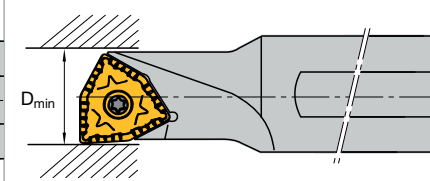
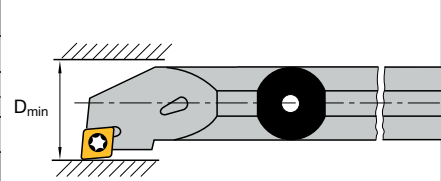
	Pentatec® PTR20 -2,25D	Pentatec® PTR20 -1,50D	ISO-Bohrstange ISO-boring bar
			
D _{min}	20	20	21
d	25/32 ¹⁾	25	16
Schaft Shank			
Plananlage Seating face	Ja Yes	Nein No	Nein No

¹⁾ Durchmesser am Bund
 Diameter on the flange

Pentatec®-Nutzen: Höhere Stabilität und geringere Vibrationsneigung durch größere Aufnahmedurchmesser und zusätzliche Plananlage bei PT-2,25D
 Pentatec®-benefits: More stability and less tendency to vibrate through larger locating diameters and the additional seating face for PT-2,25D

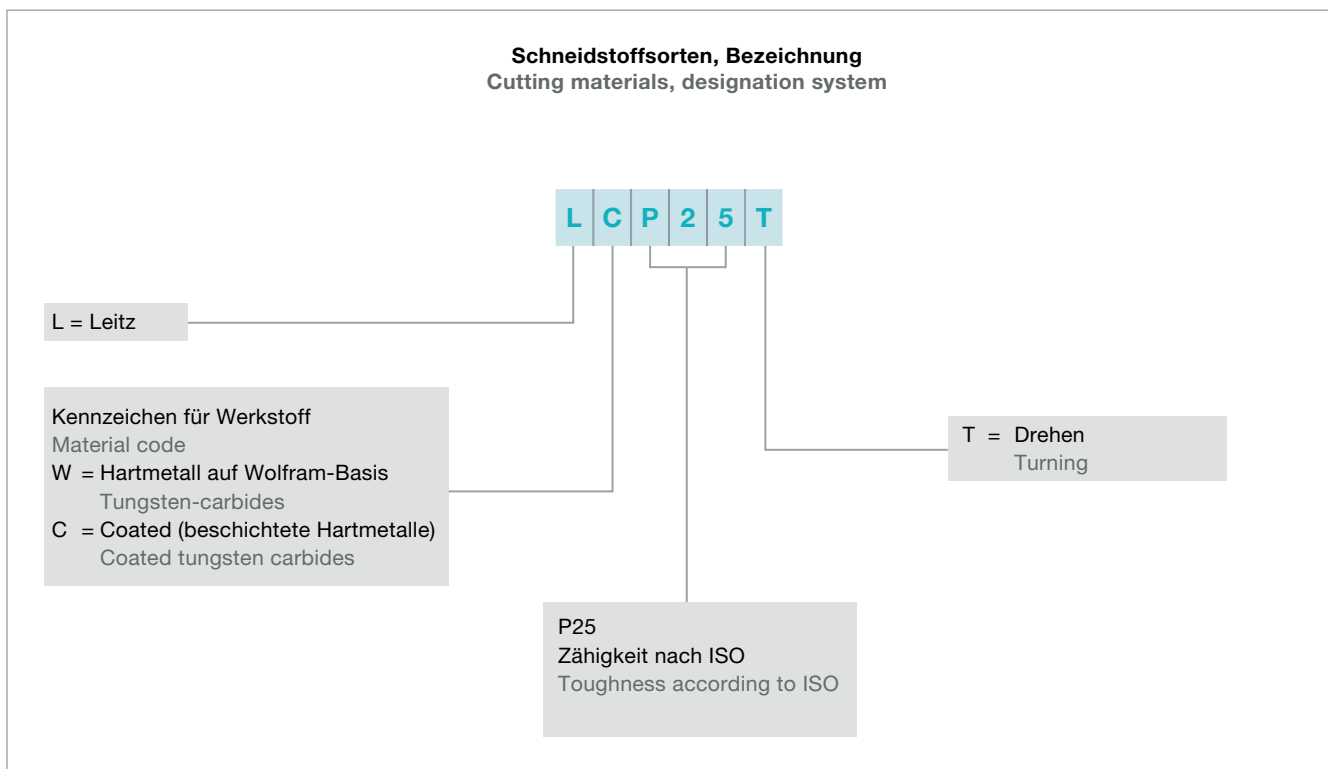
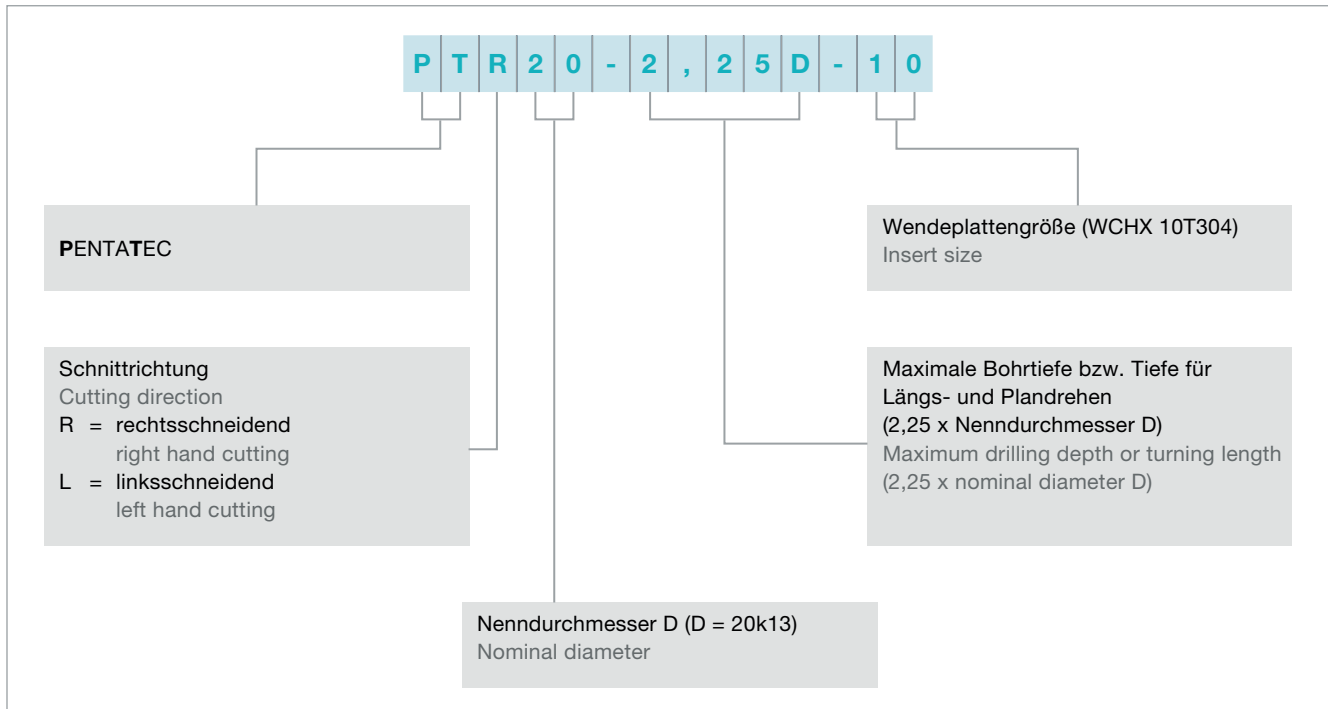

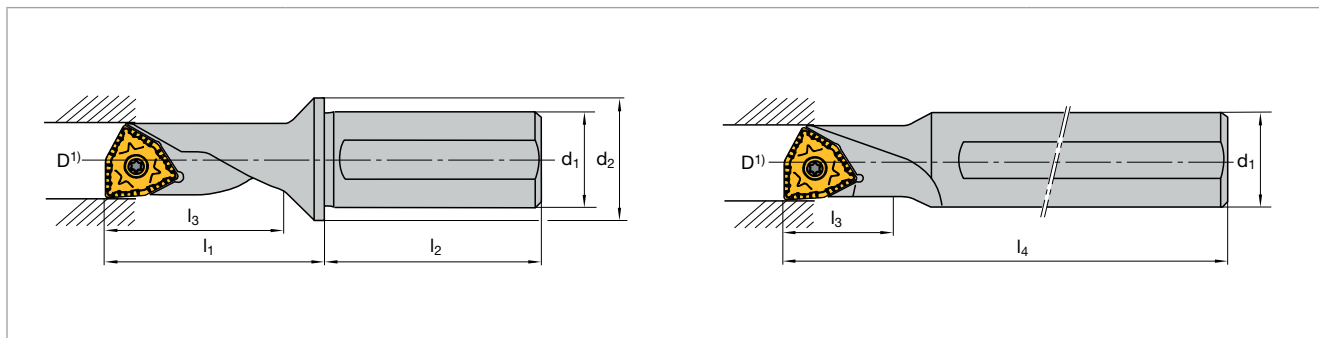







Bestellbezeichnung Ordering code	D ¹⁾	d ₁	d ₂	l ₁	l ₂	l ₃	l ₄	Passende Wendeplatte Indexable insert
PTR/L 08 - 2,25D-04	8	10	12	22,5	38	18,0	–	WCHX 04...
PTR/L 08 - 1,50D-04	8	12	–	–	–	12,0	80	
PTR/L 10 - 2,25D-05	10	12	16	28	42	22,5	–	WCHX 05...
PTR/L 10 - 1,50D-05	10	12	–	–	–	15,0	90	
PTR/L 11 - 2,25D-06	11	16	20	32	45	24,75	–	WCHX 06...
PTR/L 11 - 1,50D-06	11	16	–	–	–	16,5	100	
PTR/L 15 - 2,25D-07	15	20	25	43	50	33,75	–	WCHX 07...
PTR/L 15 - 1,50D-07	15	20	–	–	–	22,5	125	
PTR/L 18 - 2,25D-09	18	25	32	53	56	40,5	–	WCHX 09...
PTR/L 18 - 1,50D-09	18	25	–	–	–	27,0	135	
PTR/L 20 - 2,25D-10	20	25	32	56	56	45,0	–	WCHX 10...
PTR/L 20 - 1,50D-10	20	25	–	–	–	30,0	150	
PTR/L 26 - 2,25D-13	26	32	40	73	60	58,5	–	WCHX 13...
PTR/L 26 - 1,50D-13	26	32	–	–	–	39,0	180	

¹⁾ Durchmesser für Senkbohrung laut DIN 74
Diameter for plunge drilling according to DIN 74

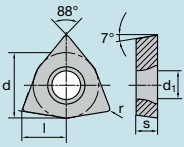
Auf Anfrage bieten wir Pentatec® Werkzeuge mit schwingungsdämpfenden Densimet (Schwermetall) an.
On request we offer Pentatec® tools with vibration damping Densimet (heavy duty metal).

Ersatzteile Spare parts				
	 Schraube Screw	 Schlüssel Key	Torx	Anzugsmoment Torque [Ncm]
PTR/L 08	A02-20033	V04-T0600	06	62
PTR/L 10	A13-25042	V04-T0800	08	128
PTR/L 11	A13-25050	V04T-0800	08	128
PTR/L 15	A13-30073	V04T-0800	08	180
PTR/L 18	A02-35082	V04-T1500	15	345
PTR/L 20	A06-50088	V04-T2000	20	1020
PTR/L 26	A02-60120	V04T-2500	25	1750

	Bestellbezeichnung Ordering code	l	d	s	d ₁	r	Sorte Grade		
							LCP25T	LCM45T	LW610
WCHX...FN-BAL 	WCHX 040102FN-BAL	4,0	6,35	1,59	2,25	0,2			6409963
	WCHX 040104FN-BAL	4,0	6,35	1,59	2,25	0,4			6407959
	WCHX 05T102FN-BAL	5,0	7,93	1,98	2,80	0,2			6409964
	WCHX 05T104FN-BAL	5,0	7,93	1,98	2,80	0,4			6407962
	WCHX 060202FN-BAL	5,5	8,93	2,38	2,80	0,2			6409965
	WCHX 060204FN-BAL	5,5	8,93	2,38	2,80	0,4			6407965
	WCHX 070304FN-BAL	7,5	12,00	3,18	3,40	0,4			6409966
	WCHX 070308FN-BAL	7,5	12,00	3,18	3,40	0,8			6407968
	WCHX 090304FN-BAL	9,0	14,29	3,18	4,40	0,4			6409967
	WCHX 090308FN-BAL	9,0	14,29	3,18	4,40	0,8			6407971
	WCHX 10T304FN-BAL	10,0	15,87	3,97	5,90	0,4			6409968
	WCHX 10T308FN-BAL	10,0	15,87	3,97	5,90	0,8			6400540
	WCHX 130508FN-BAL	13,0	21,00	5,56	7,00	0,8			6407975
WCHX...EN-BFM 	WCHX 040102EN-BFM	4,0	6,35	1,59	2,25	0,2	5056049		
	WCHX 040104EN-BFM	4,0	6,35	1,59	2,25	0,4	5056050		
	WCHX 05T102EN-BFM	5,0	7,93	1,98	2,80	0,2	5056051		
	WCHX 05T104EN-BFM	5,0	7,93	1,98	2,80	0,4	5056052		
	WCHX 060202EN-BFM	5,5	8,37	2,38	2,80	0,2	5056053		
	WCHX 060204EN-BFM	5,5	8,37	2,38	2,80	0,4	5056054		
	WCHX 070304EN-BFM	7,5	12,00	3,18	3,40	0,4	5056055		
	WCHX 070308EN-BFM	7,5	12,00	3,18	3,40	0,8	5056056		
	WCHX 090304EN-BFM	9,0	14,29	3,18	4,40	0,4	5056057		
	WCHX 090308EN-BFM	9,0	14,29	3,18	4,40	0,8	5056058		
	WCHX 10T304EN-BFM	10,0	15,87	3,97	5,90	0,4	5056059		
	WCHX 10T308EN-BFM	10,0	15,87	3,97	5,90	0,8	5056060		
	WCHX 130508EN-BFM	13,0	21,00	5,56	7,00	0,8	5056061		
WCHX...EN-BFM 	WCHX 040102EN-BFM	4,0	6,35	1,59	2,25	0,2		5062986	
	WCHX 040104EN-BFM	4,0	6,35	1,59	2,25	0,4		5063176	
	WCHX 05T102EN-BFM	5,0	7,93	1,98	2,80	0,2		5063178	
	WCHX 05T104EN-BFM	5,0	7,93	1,98	2,80	0,4		5063180	
	WCHX 060202EN-BFM	5,5	8,37	2,38	2,80	0,2		5063184	
	WCHX 060204EN-BFM	5,5	8,37	2,38	2,80	0,4		5063186	
	WCHX 070304EN-BFM	7,5	12,00	3,18	3,40	0,4		5063315	
	WCHX 070308EN-BFM	7,5	12,00	3,18	3,40	0,8		5063316	
	WCHX 090304EN-BFM	9,0	14,29	3,18	4,40	0,4		5063317	
	WCHX 090308EN-BFM	9,0	14,29	3,18	4,40	0,8		5063318	
	WCHX 10T304EN-BFM	10,0	15,87	3,97	5,90	0,4		5063322	
	WCHX 10T308EN-BFM	10,0	15,87	3,97	5,90	0,8		5063321	
	WCHX 130508EN-BFM	13,0	21,00	5,56	7,00	0,8		5063319	

Bestellbeispiel Order example: 10 Stück 10 pieces WCHX 040102FN--BAL LW610

● Verfügbar ab Lager Available from stock



Bestellbezeichnung Ordering code	d ¹⁾	d ₁	l ₁	l ₂	LC630T
PTL06-2.25D	6	8	13,5	38	6410466
PTR06-2.25D					6410467

¹⁾ = Durchmesser für Senkbohrung laut DIN 74 Diameter for plunge drilling according to DIN 74

Pentatec®-Adapter
Pentatec®-Adapter



Bestellbezeichnung Ordering code	d ₁	d ₂	d ₃	l ₁	Ident No.
PTA 25-08	8	25	29	50	6411357

Technische Hinweise
Technical hints

Sortenübersicht
Grade overview

Sorte Grade	ISO	Anwendungsbereich Application range	Werkstoffgruppe Material group						Bearbeitungsverfahren Application					
			P	M	K	N	S	H	T	M	D	S	G	P
		01 05 10 15 20 25 30 35 40 45 50	Stahl Steel	Rostfrei Stainless	Grauguss Grey cast iron	NE-Metalle (Al, etc.) Nonferrous metals	Hochwarmfest High temperature materials	Harte Werkstoffe Hard materials	Drehen Turning	Fräsen Milling	Bohren Drilling	Gewinde- bearbeitung Threading	Einstechen Grooving	Abstechen Parting
LCP25T	HC-P25		■						●		●			
	HC-M25			□					●		●			
LCM45T	HC-M40			■					●		●			
	HC-P40		■						●		●			
LW610	HW-K10				■				●		●			
Anwendungsschwerpunkt Application peak		01 05 10 15 20 25 30 35 40 45 50	■ Hauptanwendung Main application □ Weitere Anwendung Further applications						● Standardsorte Standard grade					
Gesamtbereich nach ISO 513 Full range to ISO 513														

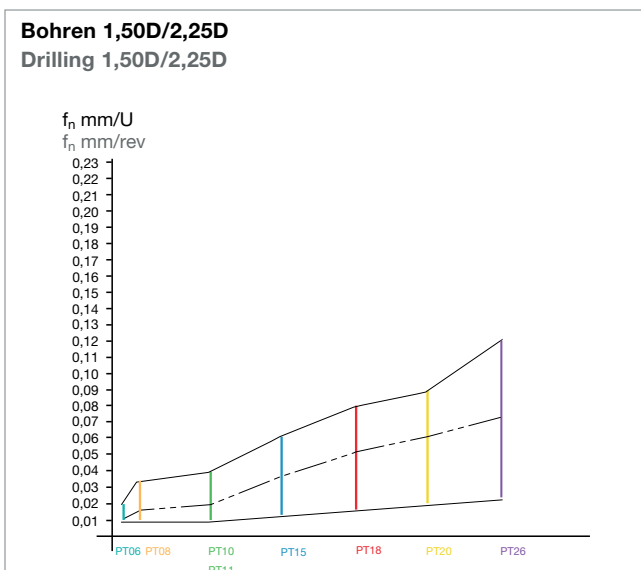
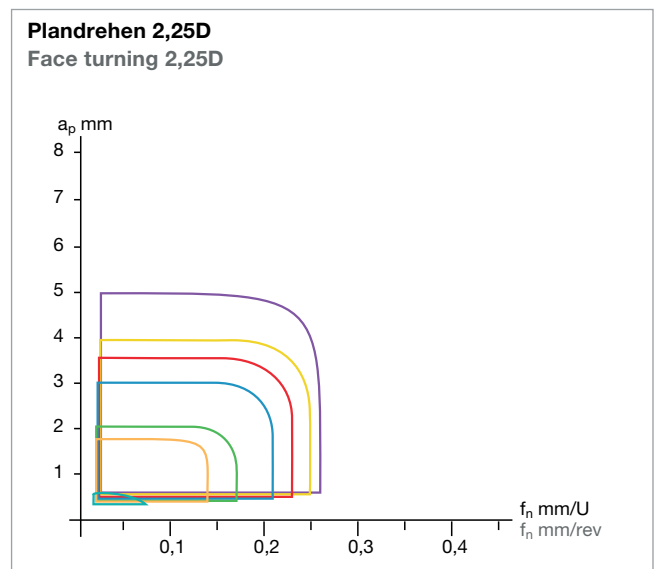
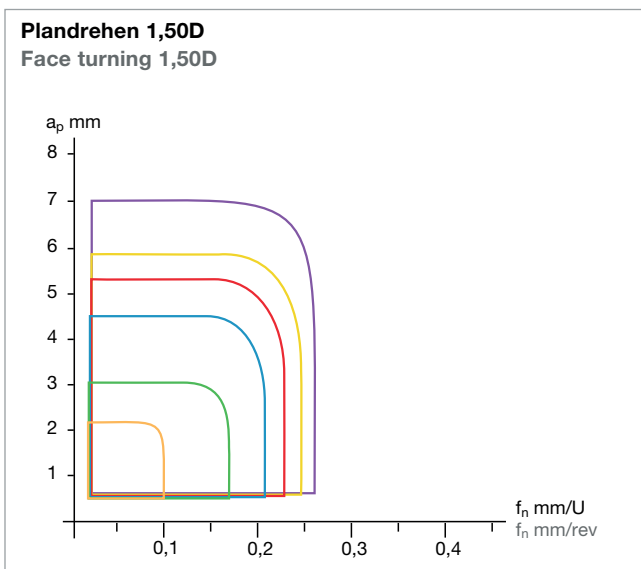
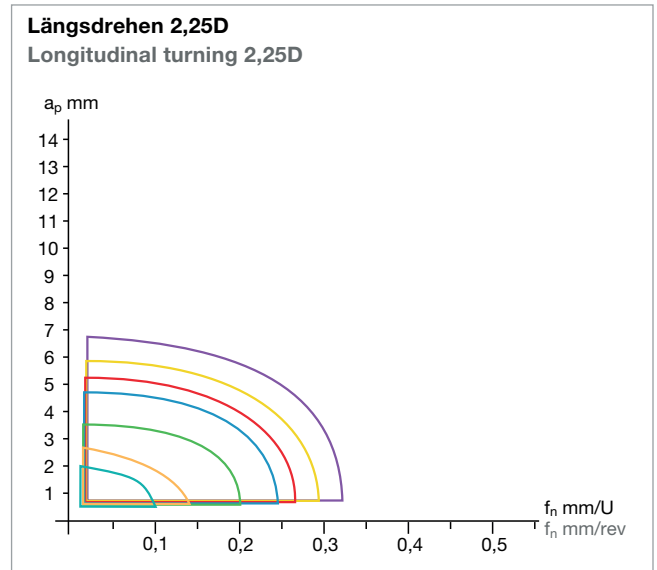
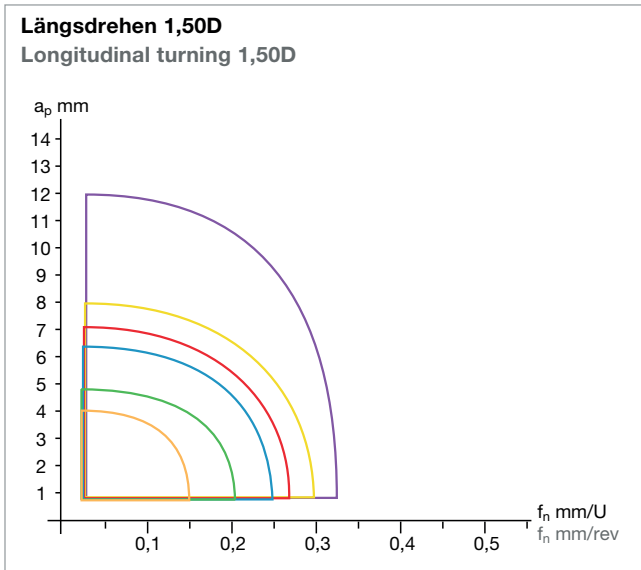

- = PT26
- = PT15
- = PT08
- = PT20
- = PT11
- = PT06¹⁾
- = PT18
- = PT10

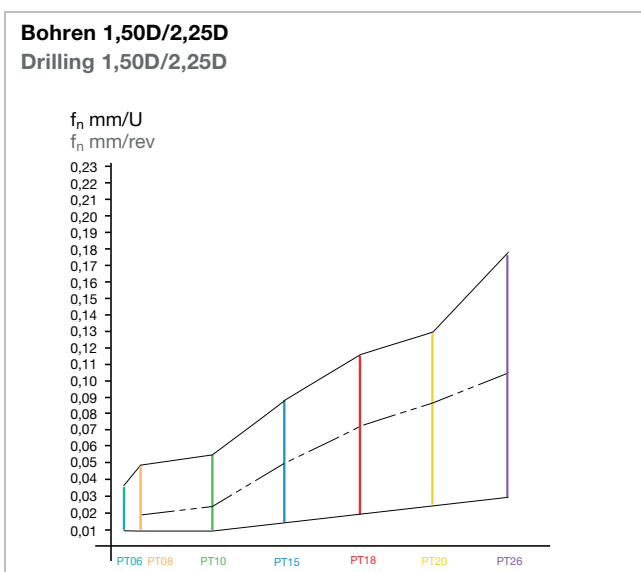
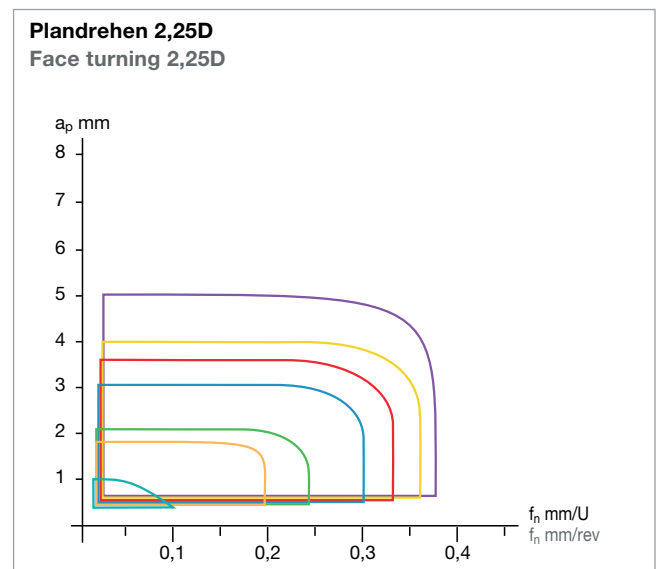
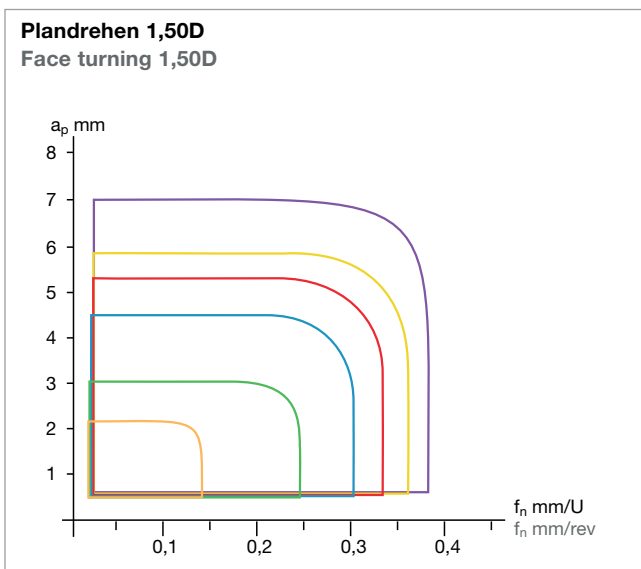
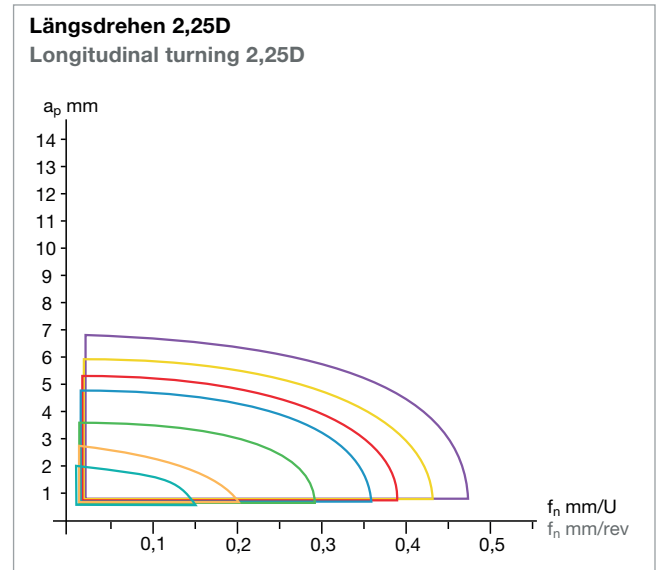
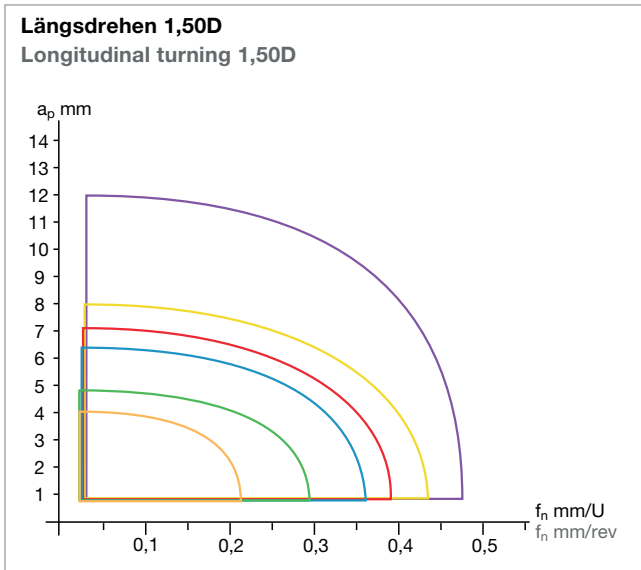

¹⁾ Für Stahl, Rostfrei und Grauguss
For steel, stainless steel and grey cast iron

Verwenden Sie die Pentatec®-Werkzeuge **immer mit Kühlung**
Use Pentatec® tools **always with coolant**



- = PT26
- = PT15
- = PT08
- = PT20
- = PT11
- = PT06
- = PT18
- = PT10

Verwenden Sie die Pentatec®-Werkzeuge **immer mit Kühlung**
Use Pentatec® tools **always with coolant**

Werkstoff Material	Brinell Härte Brinell hardness HB	Drehen und Bohren Turning and drilling v _c (m/min)			
		LCP25T	LCM45T	LW610	
					
P Unlegierter Baustahl ¹⁾ Unalloyed steel ¹⁾	ca. 0,15 %C gegläht annealed	125	170 – 300	120 – 250	
	ca. 0,45 %C gegläht annealed	190	150 – 255	100 – 200	
	ca. 0,45 %C vergütet hardened and temp.	250	100 – 200	70 – 180	
	ca. 0,75 %C gegläht annealed	270	110 – 185	70 – 180	
	ca. 0,75 %C vergütet hardened and temp.	300	90 – 160	50 – 150	
	Niedrig legierter Stahl ¹⁾ Low-alloy steel ¹⁾	geglüht annealed	180	120 – 240	80 – 200
		vergütet hardened and temp.	275	100 – 210	70 – 180
			300	100 – 185	100 – 185
	Hochlegierter Stahl und hochlegierter Werkzeugstahl ¹⁾ High-alloy steel and high alloy tool steel ¹⁾	geglüht annealed	200	130 – 215	70 – 180
		gehärtet und angelassen hardened and temp.	325	80 – 140	50 – 120
Nichtrostender Stahl ¹⁾ Stainless steel ¹⁾	ferritisch/martensitisch gegläht ferritic/martensitic annealed	200	110 – 200	70 – 150	
	martensitisch vergütet martensitic hardened and temp.	240	100 – 160	70 – 120	
M Nichtrostender Stahl ¹⁾ Stainless steel ¹⁾	austenitisch ²⁾ , abgeschreckt austenitic ²⁾ , quenched	180	90 – 160	50 – 150	
K Grauguss Grey cast iron	perlitisch/ferritisch perlitic/ferritic	180		150 – 250	
	perlitisch (martensitisch) perlitic (martensitic)	260		100 – 150	
	Gusseisen mit Kugelgraphit Nodular graphite cast iron	ferritisch ferritic	160		130 – 80
	Temperguss Malleable cast iron	perlitisch perlitic	250		100 – 150
		ferritisch ferritic	130		120 – 180
N Aluminium-Knetlegierungen Aluminium wrought alloys	nicht aushärtbar unhardenable	60		400 – 2400	
	aushärtbar, ausgehärtet hardenable, hardened	100		160 – 1600	
	Aluminium-Gusslegierungen Aluminium cast alloys	ca. 12 % Si. nicht aushärtbar ca. 12 % Si. unhardenable	75		320 – 1200
		ca. 12 % Si. aushärtbar, ausgehärtet ca. 12 % Si. hardenable, hardened	90		240 – 950
		> 12 % Si. nicht aushärtbar > 12 % Si. unhardenable	130		160 – 800
	Kupfer und Kupferlegierungen (Bronze/Messing) Copper and copper alloys (Bronze/Brass)	Automatenlegierung Pb > 1 % Free cutting alloys Pb > 1 %	110		200 – 520
		Messing, Rotguss Brass, Red bronze	90		200 – 800
		Bronze, bleifreies Kupfer und Elektrolytkupfer Bronze, non leaded copper and electrolytic copper	100		120 – 320
	Nichtmetallische Werkstoffe Nonmetallic materials	Duroplaste Duroplastics			
Faserverstärkte Kunststoffe Fibre reinforced plastics					
Hartgummi Hard rubber					
S Warmfeste Legierungen Heat resistant alloys	Fe-Basis gegläht annealed	200			
	Fe-basis ausgehärtet hardened	280			
	Ni- oder Co-Basis gegläht annealed	250			
	Ni- oder Co-Basis ausgehärtet hardened	350			
	Ni- or Co-basis gegossen cast	320			
	Titanlegierungen Titanium alloys	Reintitan Pure titanium	400 ³⁾		
	Alpha + Beta-Legierungen, ausgehärtet Alpha- and Beta-alloys hardened	1050 ³⁾			

¹⁾ und Stahlguss
and cast steel

²⁾ und austenitische/ferritische
and austenitic/ferritic

³⁾ R_m = Zugfestigkeit in N/mm²
R_m = Tensile strength in N/mm²





Nassbearbeitung
Wet machining

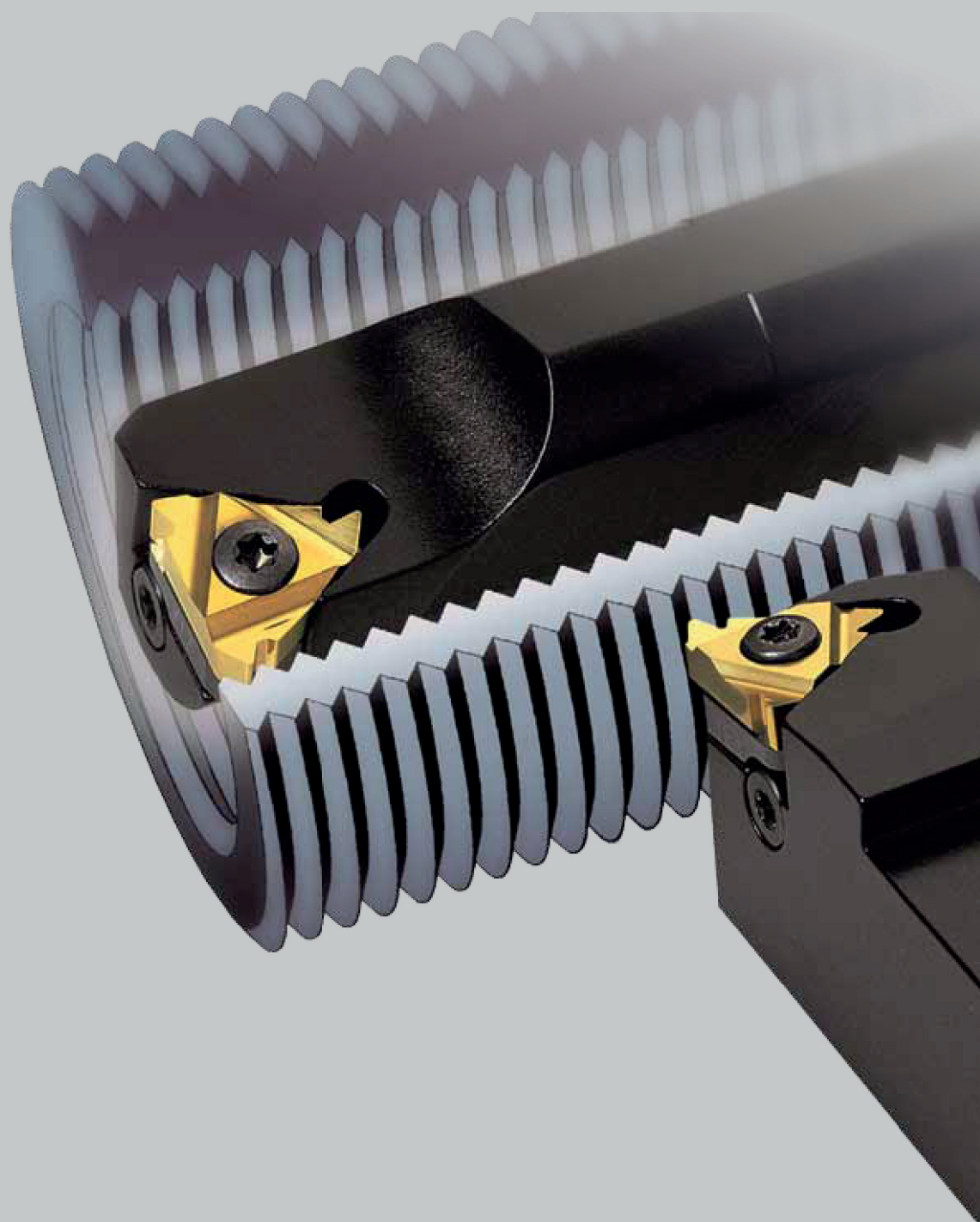

<p>Mutter/ St52 Nut</p> 	<p>Werkzeug: Tool: Pentatec® PTL15-1,50D-07</p> <p>Wendepatte/Sorte: Insert/Grade: WCHX 070304EN-BFM/LCP25T</p> <p>Anwendungen: Applications: Bohren Drilling Längsdrehen Longitudinal turning</p> <p>Kühlung: Coolant: Emulsion Emulsion</p> <p>Schnittparameter: Cutting data: v_c 150 m/min 180 m/min a_p 1 mm f 0,07 mm/U rev 0,2 mm/U rev</p> <p>Ergebnis: Result: Reduzierung der Stückzeit um 30 % Ersatz von drei Werkzeugen Reduction of machining time by 30 % Three tools replaced</p>
<p>Flansch / Aluminium Flange / Aluminium</p> 	<p>Werkzeug: Tool: Pentatec® PTR20-1,50D-10</p> <p>Wendepatte/Sorte: Insert/Grade: WCHX 10T308FN-BAL/LW610</p> <p>Anwendungen: Applications: Plandrehen Face turning Bohren Drilling</p> <p>Kühlung: Coolant: nass wet</p> <p>Schnittparameter: Cutting data: v_c 300 m/min 300 m/min a_p 2 mm f 0,15 mm/U rev 0,30 mm/U rev</p> <p>Ergebnis: Result: Reduzierung der Bearbeitungszeit um 50 % Reduction of machining time by 50 %</p>
<p>Buchse / St52 (SAE 1055) Bush</p> 	<p>Werkzeug: Tool: Pentatec® PTL20-1,50D-10</p> <p>Wendepatte/Sorte: Insert/Grade: WCHX 10T304EN-BFM/LCP25T</p> <p>Anwendungen: Applications: Bohren Drilling Ausdrehen Boring</p> <p>Kühlung: Coolant: Emulsion Emulsion</p> <p>Schnittparameter: Cutting data: v_c 200 m/min 200 m/min a_p 1,5 mm f 0,03-0,05 mm/U rev 0,15 mm/U rev</p> <p>Ergebnis: Result: 25 % kürzere Bearbeitungszeit. Ersatz eines Werkzeuges. Einsparung eines Werkzeugwechselplatzes. Reduction of machining time by 25 %. One tool replaced. One tool place saved.</p>
<p>Schmiedeteil / St37 (SAE 1035) Forged piece</p> 	<p>Werkzeug: Tool: Pentatec® PTR20-1,50D-10</p> <p>Wendepatte/Sorte: Insert/Grade: WCHX 10T304EN-BFM/LCP25T</p> <p>Anwendungen: Applications: Plandrehen, Bohren Face turning, drilling Ausdrehen Boring</p> <p>Kühlung: Cooling: Emulsion Emulsion</p> <p>Schnittparameter: Cutting data: v_c 180 m/min 180 m/min a_p 1 mm 2 mm f 0,06 mm/U rev 0,15 mm/U rev</p> <p>Ergebnis: Result: 25 % kürzere Bearbeitungszeit. Einsparung eines Bohrwerkzeuges. Reduction of machining time by 25 %. One drilling tool saved.</p>

Gewindedrehen Thread turning

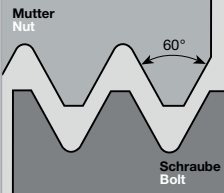

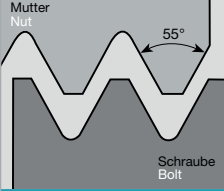

Wendeschneidplatten	137
Indexable inserts	
Teilprofil	
Partial profile	
A, AG, G, N: 55°, 60°	137
A, AG, G, N: 55°, 60°	
Vollprofil	
Full profile	
ISO-Metrisch	139
ISO Metric	
BSP	141
BSP	
Amerikanisch UN	143
American UN	
BSPT	147
BSPT	
NPT, NPTF	148
NPT, NPTF	
Trapez DIN 103	150
Trapezoidal DIN 103	
<hr/>	
Klemmhalter, Ersatzteile	152
Tool holders, spare parts	
Technische Hinweise	
Technical hints	
Schneidstoffsorten, Übersicht	155
Turning grades, overview	
Arbeitsmethoden beim Gewindedrehen	156
Thread turning methods	
Flankenfreiwinkel	156
Flank clearance angle	
Zustellungsmethoden	157
Infeed methods	
Wahl der richtigen Unterlagsplatten	157
Choosing the correct anvil	
Steigungswinkel	158
Helix angle	
Unterlagsplatten	158
Anvils	
Bearbeitungsbeispiele	159
Machining examples	
Maßnahmen bei Bearbeitungsproblemen, Gewindedrehen	160
Options against machining problems, thread turning	
Anzahl der Durchgänge	160
Number of passes	
Schnittdatenrichtwerte, Gewindedrehen	161
Cutting data standard values, thread turning	



		Teilprofil 60° Partial Profile 60°											Sorte Grade			Unterlage Anvil	Passendes Werkzeug Suitable tool holder	Seite Page
		Steigung Pitch		l	d	s	r	x	y	LCP20T	LCM25T	LWN20T						
Bestellbezeichnung Ordering Code		mm	Gang / Zoll tpi															
Rechts Right hand 	11ERA60	0,5-1,5	48-16	11	6,35	3,0	0,05	0,8	0,9	●	●	○	-	NL...-11	152			
	16ERA60	0,5-1,5	48-16	16	9,52	3,4	0,05	0,8	0,9	●	●	○	YE16	AL...-16	152			
	16ERAG60	0,5-3,0	48-8	16	9,52	3,4	0,06	1,2	1,7	●	●	○	YE16					
	16ERG60	1,75-3,0	14-8	16	9,52	3,4	0,25	1,2	1,7	●	●	○	YE16					
	22ERN60	3,5-5,0	7-5	22	12,70	4,6	0,51	1,7	2,5	●	●	○	YE22	AL...-22	152			
Links Left hand 	11ELA60	0,5-1,5	48-16	11	6,35	3,0	0,05	0,8	0,9	●	●	○	-	NL...-11	152			
	16ELA60	0,5-1,5	48-16	16	9,52	3,4	0,05	0,8	0,9	●	●	○	YI16	AL...-16	152			
	16ELAG60	0,5-3,0	48-8	16	9,52	3,4	0,06	1,2	1,7	●	●	○	YI16					
	16ELG60	1,75-3,0	14-8	16	9,52	3,4	0,25	1,2	1,7	●	●	○	YI16					
	22ELN60	3,5-5,0	7-5	22	12,70	4,6	0,51	1,7	2,5	●	●	○	YI22	AL...-22	152			

		Teilprofil 55° Partial Profile 55°											Sorte Grade			Unterlage Anvil	Passendes Werkzeug Suitable tool holder	Seite Page
		Steigung Pitch		l	d	s	r	x	y	LCP20T	LCM25T	LWN20T						
Bestellbezeichnung Ordering Code		mm	Gang / Zoll tpi															
Rechts Right hand 	11ERA55	0,5-1,5	48-16	16	9,52	3,0	0,05	0,8	0,9	●	●	○	-	NL...-11	152			
	16ERA55	0,5-1,5	48-16	16	9,52	3,4	0,05	0,8	0,9	●	●	○	YE16	AL...-16	152			
	16ERG55	1,75-3,0	14-8	16	9,52	3,4	0,20	1,2	1,7	●	●	○	YE16					
	16ERAG55	0,5-3,0	48-8	16	9,52	3,4	0,07	1,2	1,7	●	●	○	YE16					
	22ERN55	3,5-5,0	7-5	22	12,70	4,6	0,43	1,7	2,5	●	●	○	YE22	AL...-22	152			
Links Left hand 	11ELA55	0,5-1,5	48-16	16	9,52	3,0	0,05	0,8	0,9	●	●	○	-	NL...-11	152			
	16ELA55	0,5-1,5	48-16	16	9,52	3,4	0,05	0,8	0,9	●	●	○	YI16	AL...-16	152			
	16ELG55	1,75-3,0	14-8	16	9,52	3,4	0,20	1,2	1,7	●	●	○	YI16					
	16ELAG55	0,5-3,0	48-8	16	9,52	3,4	0,07	1,2	1,7	●	●	○	YI16					
	22ELN55	3,5-5,0	7-5	22	12,70	4,6	0,43	1,7	2,5	●	●	○	YI22	AL...-22	152			

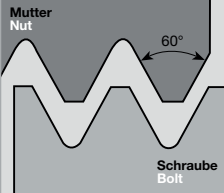
Bestellbeispiel Order example: 10 Stück pieces 11ERA60 LCP20T

- Verfügbar ab Lager Available from stock
- Auf Anfrage Upon request

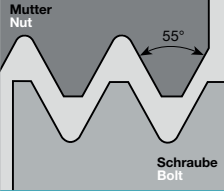
		Teilprofil 60° Partial Profile 60°											Sorte Grade			Unterlage Anvil	Passendes Werkzeug Suitable tool holder	Seite Page
		Bestellbezeichnung Ordering Code	Steigung Pitch		l	d	s	r	x	y	LCP20T	LCM25T	LWN20T					
mm	Gang / Zoll tpi		●	●							○							
Rechts Right hand 	11IRA60	0,5-1,5	48-16	11	6,35	3,0	0,05	0,8	0,9	●	●	○	-	NVR..-11	152			
	16IRA60	0,5-1,5	48-16	16	9,52	3,4	0,05	0,8	0,9	●	●	○	YI16	AVR..-16	152			
	16IRG60	1,75-3,0	14-8	16	9,52	3,4	0,15	1,2	1,7	●	●	○	YI16	NVR..-16	152			
	16IRAG60	0,5-3,0	48-8	16	9,52	3,4	0,05	1,2	1,7	●	●	○	YI16					
	22IRN60	3,5-5,0	7-5	22	12,70	4,6	0,28	1,7	2,5	●	●	○	YI22	AVR..-22	152			
														NVR..-22	152			
Links Left hand 	11ILA60	0,5-1,5	48-16	11	6,35	3,0	0,05	0,8	0,9	●	●	○	-	NVR..-11	152			
	16ILA60	0,5-1,5	48-16	16	9,52	3,4	0,05	0,8	0,9	●	●	○	YE16	AVR..-16	152			
	16ILG60	1,75-3,0	14-8	16	9,52	3,4	0,15	1,2	1,7	●	●	○	YE16	NVR..-16	152			
	16ILAG60	0,5-3,0	48-8	16	9,52	3,4	0,05	1,2	1,7	●	●	○	YE16					
	22ILN60	3,5-5,0	7-5	22	12,70	4,6	0,28	1,7	2,5	●	●	○	YE22	AVR..-22	152			
														NVR..-22	152			

		Teilprofil 55° Partial Profile 55°											Sorte Grade			Unterlage Anvil	Passendes Werkzeug Suitable tool holder	Seite Page
		Bestellbezeichnung Ordering Code	Steigung Pitch		l	d	s	r	x	y	LCP20T	LCM25T	LWN20T					
mm	Gang / Zoll tpi		●	●							○							
Rechts Right hand 	11IRA55	0,5-1,5	48-16	11	6,35	3,0	0,05	0,8	0,9	●	●	○	-	NVR..-11	152			
	16IRA55	0,5-1,5	48-16	16	9,52	3,4	0,05	0,8	0,9	●	●	○	YI16	AVR..-16	152			
	16IRG55	1,75-3,0	14-8	16	9,52	3,4	0,20	1,2	1,7	●	●	○	YI16	NVR..-16	152			
	16IRAG55	0,5-3,0	48-8	16	9,52	3,4	0,07	1,2	1,7	●	●	○	YI16					
	22IRN55	3,5-5,0	7-5	22	12,70	4,6	0,43	1,7	2,5	●	●	○	YI22	AVR..-22	152			
														NVR..-22				
Links Left hand 	11ILA55	0,5-1,5	48-16	11	6,35	3,0	0,05	0,8	0,9	●	●	○	-	NVR..-11	152			
	16ILA55	0,5-1,5	48-16	16	9,52	3,4	0,05	0,8	0,9	●	●	○	YE16	AVR..-16	152			
	16ILG55	1,75-3,0	14-8	16	9,52	3,4	0,20	1,2	1,7	●	●	○	YE16	NVR..-16	152			
	16ILAG55	0,5-3,0	48-8	16	9,52	3,4	0,07	1,2	1,7	●	●	○	YE16					
	22ILN55	3,5-5,0	7-5	22	12,70	4,6	0,43	1,7	2,5	●	●	○	YE22	AVR..-22	152			
														NVR..-22				

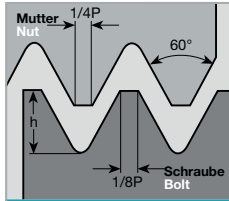

Bestellbeispiel Order example: 10 Stück pieces 11IRA60 LCP20T

- Verfügbar ab Lager Available from stock
- Auf Anfrage Upon request



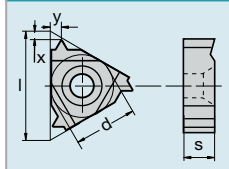

ISO-Metrisch Vollprofil
ISO-Metric Full Profile



	Bestellbezeichnung Ordering Code	Steigung Pitch		l	d	s	r	x	y	Sorte Grade			Unterlage Anvil	Passendes Werkzeug Suitable tool holder	Seite Page		
		mm	Gang / Zoll tpi							LCP20T	LCM25T	LWN20T					
Rechts Right hand 	11ER0,35ISO	0,35	-	11	6,35	3,0	-	0,8	0,4	●	●	○		NL...-11	152		
	11ER0,4ISO	0,40	-	11	6,35	3,0	-	0,7	0,4	●	●	○					
	11ER0,45ISO	0,45	-	11	6,35	3,0	-	0,7	0,4	●	●	○					
	11ER0,5ISO	0,5	-	11	6,35	3,0	-	0,6	0,4	●	●	○					
	11ER0,6ISO	0,6	-	11	6,35	3,0	-	0,6	0,6	●	●	○					
	11ER0,7ISO	0,7	-	11	6,35	3,0	-	0,6	0,6	●	●	○					
	11ER0,75ISO	0,75	-	11	6,35	3,0	-	0,6	0,6	●	●	○					
	11ER0,8ISO	0,8	-	11	6,35	3,0	-	0,6	0,6	●	●	○					
	11ER1,0ISO	1,0	-	11	6,35	3,0	-	0,7	0,7	●	●	○					
	11ER1,25ISO	1,25	-	11	6,35	3,0	-	0,8	0,9	●	●	○					
	11ER1,5ISO	1,5	-	11	6,35	3,0	-	0,8	1,0	●	●	○					
	16ER0,5ISO	0,5	-	16	9,52	3,4	-	0,6	0,4	●	●	○	YE16	AL...-16	152		
	16ER0,75ISO	0,75	-	16	9,52	3,4	-	0,6	0,6	●	●	○	YE16				
	16ER1,0ISO	1,0	-	16	9,52	3,4	-	0,7	0,7	●	●	○	YE16				
	16ER1,25ISO	1,25	-	16	9,52	3,4	-	0,8	0,9	●	●	○	YE16				
	16ER1,5ISO	1,5	-	16	9,52	3,4	-	0,8	1,0	●	●	○	YE16				
	16ER1,75ISO	1,75	-	16	9,52	3,4	-	0,9	1,2	●	●	○	YE16				
	16ER2,0ISO	2,0	-	16	9,52	3,4	-	1,0	1,3	●	●	○	YE16				
	16ER2,5ISO	2,5	-	16	9,52	3,4	-	1,1	1,5	●	●	○	YE16				
	16ER3,0ISO	3,0	-	16	9,52	3,4	-	1,2	1,6	●	●	○	YE16				
	16ER3,5ISO	3,5	-	16	9,52	3,4	-	1,2	1,6	●	●	○	YE16				
	22ER3,5ISO	3,5	-	22	12,70	4,6	-	1,6	2,3	●	●	○	YE22			AL...-22	152
	22ER4,0ISO	4,0	-	22	12,70	4,6	-	1,6	2,3	●	●	○	YE22				
	22ER4,5ISO	4,5	-	22	12,70	4,6	-	1,7	2,4	●	●	○	YE22				
	22ER5,0ISO	5,0	-	22	12,70	4,6	-	1,7	2,5	●	●	○	YE22				
	27ER6,0ISO	6,0	-	27	15,88	6,2	-	1,8	2,5	●	●	○	YE27	AL...-27	152		
	Links Left hand 	11EL0,35ISO	0,35	-	11	6,35	3,0	-	0,8	0,4	●	●	○		NL...-11	152	
11EL0,45ISO		0,45	-	11	6,35	3,0	-	0,7	0,4	●	●	○					
11EL0,5ISO		0,5	-	11	6,35	3,0	-	0,6	0,4	●	●	○					
11EL0,7ISO		0,7	-	11	6,35	3,0	-	0,6	0,6	●	●	○					
11EL0,75ISO		0,75	-	11	6,35	3,0	-	0,6	0,6	●	●	○					
11EL0,8ISO		0,8	-	11	6,35	3,0	-	0,6	0,6	●	●	○					
11EL1,0ISO		1,0	-	11	6,35	3,0	-	0,7	0,7	●	●	○					
11EL1,25ISO		1,25	-	11	6,35	3,0	-	0,8	0,9	●	●	○					
11EL1,5ISO		1,5	-	11	6,35	3,0	-	0,8	1,0	●	●	○					
16EL0,5ISO		0,5	-	16	9,52	3,4	-	0,6	0,4	●	●	○	YI16	AL...-16			152
16EL0,75ISO		0,75	-	16	9,52	3,4	-	0,6	0,6	●	●	○	YI16				
16EL1,0ISO		1,0	-	16	9,52	3,4	-	0,7	0,7	●	●	○	YI16				
16EL1,25ISO		1,25	-	16	9,52	3,4	-	0,8	0,9	●	●	○	YI16				
16EL1,5ISO		1,5	-	16	9,52	3,4	-	0,8	1,0	●	●	○	YI16				
16EL1,75ISO		1,75	-	16	9,52	3,4	-	0,9	1,2	●	●	○	YI16				
16EL2,0ISO		2,0	-	16	9,52	3,4	-	1,0	1,3	●	●	○	YI16				
16EL2,5ISO		2,5	-	16	9,52	3,4	-	1,1	1,5	●	●	○	YI16				
16EL3,0ISO		3,0	-	16	9,52	3,4	-	1,2	1,6	●	●	○	YI16				
22EL3,5ISO		3,5	-	22	12,70	4,6	-	1,6	2,3	●	●	○	YI22		AL...-22	152	
22EL4,0ISO		4,0	-	22	12,70	4,6	-	1,6	2,3	●	●	○	YI22				
22EL4,5ISO		4,5	-	22	12,70	4,6	-	1,7	2,4	●	●	○	YI22				
22EL5,0ISO		5,0	-	22	12,70	4,6	-	1,7	2,5	●	●	○	YI22	AL...-27	152		
27EL6,0ISO		6,0	-	27	15,88	6,2	-	1,7	2,5	●	●	○	YI27				

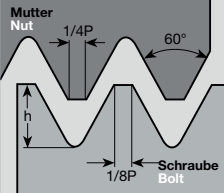

Bestellbeispiel Order example: 10 Stück pieces 11ER0,35ISO LCP20T

- Verfügbar ab Lager Available from stock
- Auf Anfrage Upon request

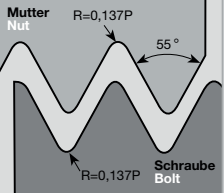

		Steigung Pitch									Sorte Grade			Unter- lage Anvil	Passendes Werkzeug Suitable tool holder	Seite Page
		mm	Gang / Zoll tpi	l	d	s	r	x	y							
										LCP20T	LCM25T	LWN20T				
Bestellbezeichnung Ordering Code																
Rechts Right hand 	11IR0,35ISO	0,35	-	11	6,35	3,0	-	0,8	0,3	●	●	○	-	NVR..-11	152	
	11IR0,45ISO	0,45	-	11	6,35	3,0	-	0,8	0,4	●	●	○				
	11IR0,6ISO	0,6	-	11	6,35	3,0	-	0,6	0,6	●	●	○				
	11IR0,7ISO	0,7	-	11	6,35	3,0	-	0,6	0,6	●	●	○				
	11IR0,75ISO	0,75	-	11	6,35	3,0	-	0,6	0,6	●	●	○				
	11IR0,8ISO	0,8	-	11	6,35	3,0	-	0,6	0,6	●	●	○				
	11IR1,0ISO	1,0	-	11	6,35	3,0	-	0,6	0,7	●	●	○	-			
	11IR1,25ISO	1,25	-	11	6,35	3,0	-	0,8	0,9	●	●	○				
	11IR1,5ISO	1,5	-	11	6,35	3,0	-	0,8	1,0	●	●	○	-			
	16IR1,0ISO	1,0	-	16	9,52	3,4	-	0,6	0,7	●	●	○	YI16			AVR..-16
	16IR1,25ISO	1,25	-	16	9,52	3,4	-	0,8	0,9	●	●	○	YI16	NVR..-16	152	
	16IR1,50ISO	1,50	-	16	9,52	3,4	-	0,8	1,0	●	●	○	YI16			
	16IR1,75ISO	1,75	-	16	9,52	3,4	-	0,9	1,2	●	●	○	YI16			
	16IR2,0ISO	2,0	-	16	9,52	3,4	-	1,0	1,3	●	●	○	YI16			
	16IR2,5ISO	2,5	-	16	9,52	3,4	-	1,1	1,5	●	●	○	YI16			
	16IR3,0ISO	3,0	-	16	9,52	3,4	-	1,1	1,5	●	●	○	YI16			
	16IR3,5ISO	3,5	-	16	9,52	3,4	-	1,2	1,5	●	●	○	YI16			
	22IR3,5ISO	3,5	-	22	12,70	4,6	-	1,6	2,3	●	●	○	YI16	AVR..-22	152	
	22IR4,0ISO	4,0	-	22	12,70	4,6	-	1,6	2,3	●	●	○	YI16	NVR..-22	152	
	22IR4,5ISO	4,5	-	22	12,70	4,6	-	1,6	2,4	●	●	○	YI16			
22IR5,0ISO	5,0	-	27	12,70	4,6	-	1,6	2,3	●	●	○	YI16				
27IR6,0ISO	6,0	-	27	15,88	6,2	-	1,8	2,5	●	●	○	YI27	AVR..-27	152		
													NVR..-27	152		
Links Left hand 	11IL0,35ISO	0,35	-	11	6,35	3,0	-	0,8	0,3	●	●	○	-	NVR..-11	152	
	11IL0,7ISO	0,7	-	11	6,35	3,0	-	0,6	0,6	●	●	○				
	11IL0,8ISO	0,8	-	11	6,35	3,0	-	0,6	0,6	●	●	○				
	11IL1,0ISO	1,0	-	11	6,35	3,0	-	0,6	0,7	●	●	○	-	AVR..-16	152	
	16IL1,0ISO	1,0	-	16	9,52	3,4	-	0,6	0,7	●	●	○	YE16			
	16IL1,25ISO	1,25	-	16	9,52	3,4	-	0,8	0,9	●	●	○	YE16	NVR..-16	152	
	16IL1,50ISO	1,50	-	16	9,52	3,4	-	0,8	1,0	●	●	○	YE16			
	16IL1,75ISO	1,75	-	16	9,52	3,4	-	0,9	1,2	●	●	○	YE16			
	16IL2,0ISO	2,0	-	16	9,52	3,4	-	1,0	0,6	●	●	○	YE16			
	16IL0,8ISO	0,8	-	16	9,52	3,4	-	0,6	1,3	●	●	○	YE16			
	16IL2,5ISO	2,5	-	16	9,52	3,4	-	1,1	1,5	●	●	○	YE16			
	16IL3,0ISO	3,0	-	16	9,52	3,4	-	1,2	1,5	●	●	○	YE16			
	16IL3,5ISO	3,5	-	16	9,52	3,4	-	1,1	1,5	●	●	○	YE16			
	22IL3,5ISO	3,5	-	22	12,70	4,6	-	1,6	2,3	●	●	○	YE22	AVR..-22	152	
	22IL4,0ISO	4,0	-	22	12,70	4,6	-	1,6	2,3	●	●	○	YE22	NVR..-22	152	
	22IL4,5ISO	4,5	-	22	12,70	4,6	-	1,6	2,4	●	●	○	YE22			
	22IL5,0ISO	5,0	-	22	12,70	4,6	-	1,6	2,3	●	●	○	YE22			
27IL6,0ISO	6,0	-	27	15,88	6,2	-	1,8	2,5	●	●	○	YE27	AVR..-27	152		
													NVR..-27	152		

Bestellbeispiel Order example: 10 Stück pieces 11IR0,35ISO LCM25T

- Verfügbar ab Lager Available from stock
- Auf Anfrage Upon request

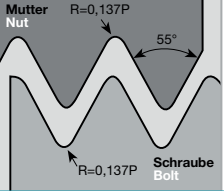

 BSP Vollprofil BSP Full Profile		Steigung Pitch		l	d	s	r	x	y	Sorte Grade			Unterlage Anvil	Passendes Werkzeug Suitable tool holder	Seite Page
		Bestellbezeichnung Ordering Code	mm							Gang / Zoll tpi	LCP20T	LCM25T			
Rechts Right hand 	11ER28W	-	28	11	6,35	3,0	-	0,6	0,7	●	●	○		NL...-11	152
	11ER19W	-	19	11	6,35	3,0	-	0,8	1,0	●	●	○			
	11ER14W	-	14	11	6,35	3,0	-	1,0	1,2	●	●	○			
	16ER28W	-	28	16	9,52	3,4	-	0,6	0,7	●	●	○	YE16	AVR...-16	152
	16ER19W	-	19	16	9,52	3,4	-	0,8	1,0	●	●	○	YE16	NVR...-16	152
	16ER14W	-	14	16	9,52	3,4	-	1,0	1,2	●	●	○	YE16		
	16ER11W	-	11	16	9,52	3,4	-	1,1	1,5	●	●	○	YE16		

Wendeschneidplatten - Innengewinde
Indexable inserts - internal threads

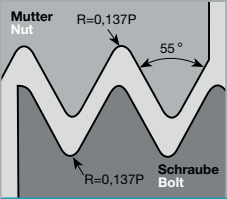
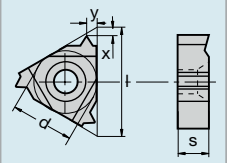

 BSP Vollprofil BSP Full Profile		Steigung Pitch		l	d	s	r	x	y	Sorte Grade			Unterlage Anvil	Passendes Werkzeug Suitable tool holder	Seite Page
		Bestellbezeichnung Ordering Code	mm							Gang / Zoll tpi	LCP20T	LCM25T			
Rechts Right hand 	11IR28W	-	28	11	6,35	3,0	-	0,6	0,7	●	●	○	-	NVR...-11	152
	11IR19W	-	19	11	6,35	3,0	-	0,8	1,0	●	●	○	-		
	11IR14W	-	14	11	6,35	3,0	-	0,9	1,1	●	●	○	-		
	16IR28W	-	28	16	9,52	3,4	-	0,6	0,7	●	●	○	YI16	AVR...-16	152
	16IR19W	-	19	16	9,52	3,4	-	0,8	1,0	●	●	○	YI16	NVR...-16	152
	16IR14W	-	14	16	9,52	3,4	-	1,0	1,2	●	●	○	YI16		
	16IR11W	-	11	16	9,52	3,4	-	1,1	1,5	●	●	○	YI16		

Bestellbeispiel Order example: 10 Stück pieces 16ER28W LCP20T

- Verfügbar ab Lager
Available from stock
- Auf Anfrage
Upon request

 BSP Vollprofil BSP Full Profile		Steigung Pitch		l	d	s	r	x	y	Sorte Grade			Unterlage Anvil	Passendes Werkzeug Suitable tool holder	Seite Page
		mm	Gang / Zoll tpi							LCP20T	LCM25T	LWN20T			
 Bestellbezeichnung Ordering Code		mm	Gang / Zoll tpi	l	d	s	r	x	y	LCP20T	LCM25T	LWN20T	Unterlage Anvil	Passendes Werkzeug Suitable tool holder	Seite Page
Links Left hand 	16EL28W	-	28	16	9,52	3,4	-	0,6	0,7	<input type="radio"/>	<input type="radio"/>	<input type="radio"/>	YI16	AL...-16	152
	16EL19W	-	19	16	9,52	3,4	-	0,8	1,0	<input type="radio"/>	<input type="radio"/>	<input type="radio"/>	YI16		
	16EL14W	-	14	16	9,52	3,4	-	1,0	1,2	<input type="radio"/>	<input type="radio"/>	<input type="radio"/>	YI16		
	16EL11W	-	11	16	9,52	3,4	-	1,1	1,5	<input type="radio"/>	<input type="radio"/>	<input type="radio"/>	YI16		

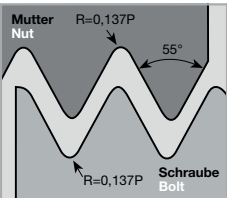
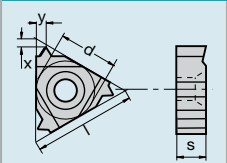
Wendeschneidplatten - Innengewinde
Indexable inserts - internal threads

 BSP Vollprofil BSP Full Profile		Steigung Pitch		l	d	s	r	x	y	Sorte Grade			Unterlage Anvil	Passendes Werkzeug Suitable tool holder	Seite Page
		mm	Gang / Zoll tpi							LCP20T	LCM25T	LWN20T			
 Bestellbezeichnung Ordering Code		mm	Gang / Zoll tpi	l	d	s	r	x	y	LCP20T	LCM25T	LWN20T	Unterlage Anvil	Passendes Werkzeug Suitable tool holder	Seite Page
Links Left hand 	11IL19W	-	19	11	6,35	3,0	-	0,8	1,0	<input type="radio"/>	<input type="radio"/>	<input type="radio"/>	-	NVR...-11	152
	11IL14W	-	14	11	6,35	3,0	-	0,9	1,1	<input type="radio"/>	<input type="radio"/>	<input type="radio"/>	-		
	16IL28W	-	28	16	9,52	3,4	-	0,6	0,7	<input type="radio"/>	<input type="radio"/>	<input type="radio"/>	YE16	AVR...-16	152
	16IL19W	-	19	16	9,52	3,4	-	0,8	1,0	<input type="radio"/>	<input type="radio"/>	<input type="radio"/>	YE16	NVR...-16	
	16IL14W	-	14	16	9,52	3,4	-	1,0	1,2	<input type="radio"/>	<input type="radio"/>	<input type="radio"/>	YE16		
	16IL11W	-	11	16	9,52	3,4	-	1,1	1,5	<input type="radio"/>	<input type="radio"/>	<input type="radio"/>	YE16		

Bestellbeispiel Order example: 10 Stück pieces 16EL28W LCP20T

- Verfügbar ab Lager Available from stock
- Auf Anfrage Upon request

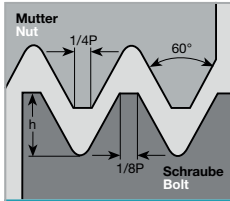

Amerikanisch UN Vollprofil
American UN Full Profile

	Bestellbezeichnung Ordering Code	Steigung Pitch		l	d	s	r	x	y	Sorte Grade			Unterlage Anvil	Passendes Werkzeug Suitable tool holder	Seite Page
		mm	Gang / Zoll tpi							LCP20T	LCM25T	LWN20T			
Rechts Right hand 	16ER72UN	-	72	16	9,52	3,4	-	0,8	0,4	○	○	○	YE16	AL...-16	152
	16ER64UN	-	64	16	9,52	3,4	-	0,8	0,4	○	○	○	YE16		
	16ER56UN	-	56	16	9,52	3,4	-	0,7	0,4	○	○	○	YE16		
	16ER48UN	-	48	16	9,52	3,4	-	0,6	0,6	○	○	○	YE16		
	16ER44UN	-	44	16	9,52	3,4	-	0,6	0,6	○	○	○	YE16		
	16ER40UN	-	40	16	9,52	3,4	-	0,6	0,6	○	○	○	YE16		
	16ER36UN	-	36	16	9,52	3,4	-	0,6	0,6	○	○	○	YE16		
	16ER32UN	-	32	16	9,52	3,4	-	0,6	0,6	○	○	○	YE16		
	16ER28UN	-	28	16	9,52	3,4	-	0,6	0,7	○	○	○	YE16		
	16ER27UN	-	27	16	9,52	3,4	-	0,7	0,8	○	○	○	YE16		
	16ER24UN	-	24	16	9,52	3,4	-	0,7	0,8	○	○	○	YE16		
	16ER20UN	-	20	16	9,52	3,4	-	0,8	0,9	○	○	○	YE16		
	16ER18UN	-	18	16	9,52	3,4	-	0,8	1	○	○	○	YE16		
	16ER16UN	-	16	16	9,52	3,4	-	0,9	1,1	○	○	○	YE16		
	16ER14UN	-	14	16	9,52	3,4	-	1	1,2	○	○	○	YE16		
	16ER13UN	-	13	16	9,52	3,4	-	1	1,3	○	○	○	YE16		
	16ER12UN	-	12	16	9,52	3,4	-	1,1	1,4	○	○	○	YE16		
	16ER11UN	-	11	16	9,52	3,4	-	1,1	1,5	○	○	○	YE16		
	16ER10UN	-	10	16	9,52	3,4	-	1,1	1,5	○	○	○	YE16		
	16ER9UN	-	9	16	9,52	3,4	-	1,2	1,7	○	○	○	YE16		
	16ER8UN	-	8	16	9,52	3,4	-	1,2	1,6	○	○	○	YE16		
	22ER7UN	-	7	22	12,70	4,6	-	1,6	2,3	○	○	○	YE22	AL...-22	152
	22ER6UN	-	6	22	12,70	4,6	-	1,6	2,3	○	○	○	YE22		
	22ER5UN	-	5	22	12,70	4,6	-	1,7	2,5	○	○	○	YE22		

Bestellbeispiel Order example: 10 Stück piece 16ER72UN LCP20T

- Verfügbar ab Lager Available from stock
- Auf Anfrage Upon request

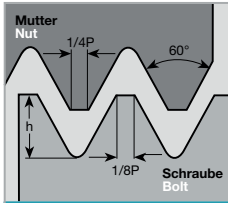



Amerikanisch UN Vollprofil
American UN Full Profile

	Bestellbezeichnung Ordering Code	Steigung Pitch		l	d	s	r	x	y	Sorte Grade			Unterlage Anvil	Passendes Werkzeug Suitable tool holder	Seite Page
		mm	Gang / Zoll tpi							LCP20T	LCM25T	LWN20T			
Rechts Right hand 	11IR72UN	-	72	11	6,35	3,0	-	0,8	0,3				-	NVR..-11	152
	11IR64UN	-	64	11	6,35	3,0	-	0,8	0,4	○			-		
	11IR56UN	-	56	11	6,35	3,0	-	0,7	0,4	○			-		
	11IR48UN	-	48	11	6,35	3,0	-	0,6	0,6	○			-		
	11IR40UN	-	40	11	6,35	3,0	-	0,6	0,6	○			-		
	11IR36UN	-	36	11	6,35	3,0	-	0,6	0,6	○			-		
	11IR32UN	-	32	11	6,35	3,0	-	0,6	0,6	○	○		-		
	11IR28UN	-	28	11	6,35	3,0	-	0,6	0,7	○	○		-		
	11IR27UN	-	27	11	6,35	3,0	-	0,7	0,8	○			-		
	11IR24UN	-	24	11	6,35	3,0	-	0,7	0,8	○	○		-		
	11IR20UN	-	20	11	6,35	3,0	-	0,8	0,9	○	○		-		
	11IR18UN	-	18	11	6,35	3,0	-	0,8	1,0	○	○		-		
	11IR16UN	-	16	11	6,35	3,0	-	0,9	1,1	○	○		-		
	11IR14UN	-	14	11	6,35	3,0	-	0,9	1,1	○	○		-		
	16IR56UN	-	56	16	9,52	3,4	-	0,7	0,4			○	YI16	AVR..-16	152
	16IR48UN	-	48	16	9,52	3,4	-	0,6	0,6	○	○		YI16	NVR..-16	
	16IR44UN	-	44	16	9,52	3,4	-	0,6	0,6	○	○		YI16		
	16IR40UN	-	40	16	9,52	3,4	-	0,6	0,6	○	○		YI16		
	16IR36UN	-	36	16	9,52	3,4	-	0,6	0,6	○	○		YI16		
	16IR32UN	-	32	16	9,52	3,4	-	0,6	0,6	○	○		YI16		
	16IR28UN	-	28	16	9,52	3,4	-	0,6	0,7	○	○		YI16		
	16IR27UN	-	27	16	9,52	3,4	-	0,7	0,8	○	○		YI16		
	16IR24UN	-	24	16	9,52	3,4	-	0,7	0,8	○	○		YI16		
	16IR20UN	-	20	16	9,52	3,4	-	0,8	0,9	○	○		YI16		
	16IR18UN	-	18	16	9,52	3,4	-	0,8	1,0	○	○		YI16		
	16IR16UN	-	16	16	9,52	3,4	-	0,9	1,1	○	○		YI16		
	16IR14UN	-	14	16	9,52	3,4	-	0,9	1,2	○	○		YI16		
	16IR13UN	-	13	16	9,52	3,4	-	1,0	1,3	○	○		YI16		
	16IR12UN	-	12	16	9,52	3,4	-	1,1	1,4	○	○		YI16		
	16IR11,5UN	-	11,5	16	9,52	3,4	-	1,1	1,5	○	○		YI16		
	16IR11UN	-	11	16	9,52	3,4	-	1,1	1,5	○	○		YI16		
	16IR10UN	-	10	16	9,52	3,4	-	1,1	1,5	○	○		YI16		
	16IR9UN	-	9	16	9,52	3,4	-	1,2	1,7	○	○		YI16		
	16IR8UN	-	8	16	9,52	3,4	-	1,1	1,5	○	○		YI16		
	22IR7UN	-	7	22	12,70	4,6	-	1,6	2,3	○	○		YI22	AVR..-22	152
	22IR6UN	-	6	22	12,70	4,6	-	1,6	2,3	○	○		YI22	NVR..-22	
	22IR5UN	-	5	22	12,70	4,6	-	1,6	2,3	○	○		YI22		

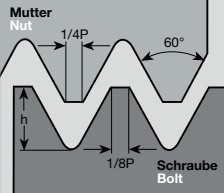

Bestellbeispiel Order example: 10 Stück pieces 11IR72UN LCP20T

- Verfügbar ab Lager Available from stock
- Auf Anfrage Upon request

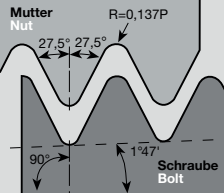
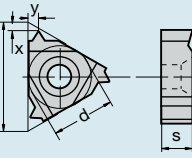

		Amerikanisch UN Vollprofil American UN Full Profile											Sorte Grade	Unterlage Anvil	Passendes Werkzeug Suitable tool holder	Seite Page	
		Bestellbezeichnung Ordering Code	Steigung Pitch		l	d	s	r	x	y	LCP20T	LCM25T					LWN20T
			mm	Gang / Zoll tpi													
Links Left hand 	16EL56UN	-	56	16	9,52	3,4	-	0,7	0,4				YI16	AL...-16	152		
	16EL48UN	-	48	16	9,52	3,4	-	0,6	0,6	○	○	○	YI16				
	16EL44UN	-	44	16	9,52	3,4	-	0,6	0,6	○	○	○	YI16				
	16EL40UN	-	40	16	9,52	3,4	-	0,6	0,6	○	○	○	YI16				
	16EL36UN	-	36	16	9,52	3,4	-	0,6	0,6	○	○	○	YI16				
	16EL32UN	-	32	16	9,52	3,4	-	0,6	0,6	○	○	○	YI16				
	16EL28UN	-	28	16	9,52	3,4	-	0,6	0,7	○	○	○	YI16				
	16EL27UN	-	27	16	9,52	3,4	-	0,7	0,8	○	○	○	YI16				
	16EL24UN	-	24	16	9,52	3,4	-	0,7	0,8	○	○	○	YI16				
	16EL20UN	-	20	16	9,52	3,4	-	0,8	0,9	○	○	○	YI16				
	16EL18UN	-	18	16	9,52	3,4	-	0,8	1,0	○	○	○	YI16				
	16EL16UN	-	16	16	9,52	3,4	-	0,9	1,1	○	○	○	YI16				
	16EL14UN	-	14	16	9,52	3,4	-	1,0	1,2	○	○	○	YI16				
	16EL13UN	-	13	16	9,52	3,4	-	1,0	1,3	○	○	○	YI16				
	16EL12UN	-	12	16	9,52	3,4	-	1,1	1,4	○	○	○	YI16				
	16EL11UN	-	11	16	9,52	3,4	-	1,1	1,5	○	○	○	YI16				
	16EL10UN	-	10	16	9,52	3,4	-	1,1	1,5	○	○	○	YI16				
	16EL9UN	-	9	16	9,52	3,4	-	1,2	1,7	○	○	○	YI16				
	16EL8UN	-	8	16	9,52	3,4	-	1,2	1,6	○	○	○	YI16				
	22EL7UN	-	7	22	12,70	4,6	-	1,6	2,3	○	○	○	YI22	AL...-22			
	22EL6UN	-	6	22	12,70	4,6	-	1,6	2,3	○	○	○	YI22				
	22EL5UN	-	5	22	12,70	4,6	-	1,7	2,5	○	○	○	YI22				

Bestellbeispiel Order example: 10 Stück pieces 16EL72UN LCP20T

- Verfügbar ab Lager Available from stock
- Auf Anfrage Upon request

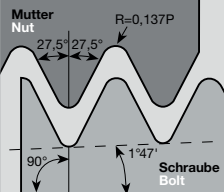
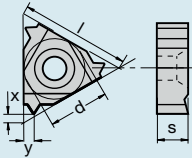

												Sorte Grade			Unter- lage Anvil	Passendes Werkzeug Suitable tool holder	Seite Page
		Steigung Pitch		l	d	s	r	x	y	LCP20T	LCM25T	LWN20T					
		Bestellbezeichnung Ordering Code	mm							Gang / Zoll tpi							
Rechts Right hand 	16ER28BSPT	-	28	16	9,52	3,4	-	0,6	0,6	○	○	○	YE16	AL...-16	152		
	16ER19BSPT	-	19	16	9,52	3,4	-	0,8	0,9	○	○	○	YE16				
	16ER14BSPT	-	14	16	9,52	3,4	-	1,0	1,2	○	○	○	YE16	AL...-16	152		
	16ER11BSPT	-	11	16	9,52	3,4	-	1,1	1,5	○	○	○	YE16				
Links Left hand 	16EL14BSPT	-	14	16	9,52	3,4	-	1,0	1,2	○			YI16	AL...-16	152		
	16EL11BSPT	-	11	16	9,52	3,4	-	1,1	1,5	○			YI16				



Wendeschneidplatten - Innengewinde
Indexable inserts - internal threads

												Sorte Grade			Unter- lage Anvil	Passendes Werkzeug Suitable tool holder	Seite Page
		Steigung Pitch		l	d	s	r	x	y	LCP20T	LCM25T	LWN20T					
		Bestellbezeichnung Ordering Code	mm							Gang / Zoll tpi							
Rechts Right hand 	11IR19BSPT	-	19	11	6,35	3,0	-	0,8	0,9	○	○	○	-	NVR...-11	152		
	11IR14BSPT	-	14	11	6,35	3,0	-	0,9	1,0	○	○	○	-				
	16IR28BSPT	-	28	16	9,52	3,4	-	0,6	0,6	○			YI16	AVR...-16	152		
	16IR19BSPT	-	19	16	9,52	3,4	-	0,8	0,9	○			YI16				
	16IR14BSPT	-	14	16	9,52	3,4	-	1,0	1,2	○	○	○	YI16	NVR...-16	152		
	16IR11BSPT	-	11	16	9,52	3,4	-	1,1	1,5	○	○	○	YI16				
Links Left hand 	11IL14BSPT	-	14	11	6,35	3,0	-	0,9	1,0	○			-	NVR...-11	152		
	16IL14BSPT	-	19	16	9,52	3,4	-	0,8	0,9	○			YE16			AVR...-16	152
	16IL11BSPT	-	28	16	9,52	3,4	-	0,6	0,6	○			YE16	NVR...-16	152		

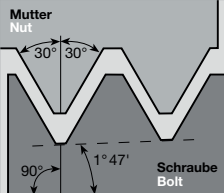
Bestellbeispiel Order example: 10 Stück pieces 16ER28BSPT LCP20T

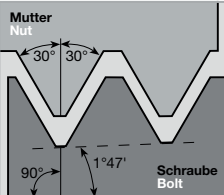

- Verfügbar ab Lager Available from stock
- Auf Anfrage Upon request



												Sorte Grade			Unterlage Anvil	Passendes Werkzeug Suitable tool holder	Seite Page
		Steigung Pitch		l	d	s	r	x	y	LCP20T	LCM25T	LWN20T					
Bestellbezeichnung Ordering Code		mm	Gang / Zoll tpi														
Rechts Right hand 	16ER27NPT	-	27	16	9,52	3,4	-	0,7	0,8	○	○	○	YE16	AL..-16	152		
	16ER18NPT	-	18	16	9,52	3,4	-	0,8	1,0	○	○	○	YE16				
	16ER14NPT	-	14	16	9,52	3,4	-	0,9	1,2	○	○	○	YE16				
	16ER11,5NPT	-	11,5	16	9,52	3,4	-	1,1	1,5	○	○	○	YE16				
	16ER8NPT	-	8	16	9,52	3,4	-	1,3	1,8	○	○	○	YE16				
Links Left hand 	16EL27NPT	-	27	16	9,52	3,4	-	0,7	0,8	○	○	○	YI16	AL..-16	152		
	16EL18NPT	-	18	16	9,52	3,4	-	0,8	1,0	○	○	○	YI16				
	16EL14NPT	-	14	16	9,52	3,4	-	0,9	1,2	○	○	○	YI16				
	16EL11,5NPT	-	11,5	16	9,52	3,4	-	1,1	1,5	○	○	○	YI16				
	16EL8NPT	-	8	16	9,52	3,4	-	1,3	1,8	○	○	○	YI16				

												Sorte Grade			Unterlage Anvil	Passendes Werkzeug Suitable tool holder	Seite Page
		Steigung Pitch		l	d	s	r	x	y	LCP20T	LCM25T	LWN20T					
Bestellbezeichnung Ordering Code		mm	Gang / Zoll tpi														
Rechts Right hand 	16ER27NPTF	-	8	16	9,52	3,4	-	1,3	1,8	○	○	○	YE16	AL..-16	152		
	16ER18NPTF	-	11,5	16	9,52	3,4	-	1,1	1,5	○	○	○	YE16				
	16ER14NPTF	-	14	16	9,52	3,4	-	0,9	1,2	○	○	○	YE16				
	16ER11,5NPTF	-	18	16	9,52	3,4	-	0,8	1,0	○	○	○	YE16				
	16ER8NPTF	-	27	16	9,52	3,4	-	0,7	0,8	○	○	○	YE16				
Links Left hand 	16EL18NPTF	-	11,5	16	9,52	3,4	-	1,1	1,5	○	○	○	YI16	AL..-16	152		

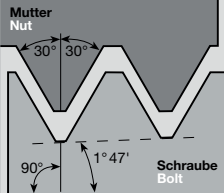
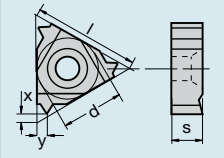
Bestellbeispiel Order example: 10 Stück pieces 16ER27NPT LCP20T

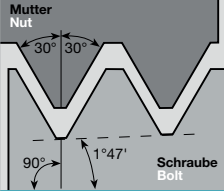

- Verfügbar ab Lager Available from stock
- Auf Anfrage Upon request

		NPT - Vollprofil NPT - Full Profile										Sorte Grade			Unter- lage Anvil	Passendes Werkzeug Suitable tool holder	Seite Page
		Bestellbezeichnung Ordering Code	Steigung Pitch		l	d	s	r	x	y	LCP20T	LCM25T	LWN20T				
			mm	Gang / Zoll tpi													
Rechts Right hand 	11IR27NPT	-	14	11	6,35	3,0	-	0,8	1,0	<input type="radio"/>	<input type="radio"/>	<input type="radio"/>	-	NVR..-11	152		
	11IR18NPT	-	18	11	6,35	3,0	-	0,8	1,0	<input type="radio"/>	<input type="radio"/>	<input type="radio"/>	-				
	11IR14NPT	-	27	11	6,35	3,0	-	0,7	0,8	<input type="radio"/>	<input type="radio"/>	<input type="radio"/>	-	NVR..-16	152		
	16IR27NPT	-	8	16	9,52	3,4	-	1,3	1,8	<input type="radio"/>	<input type="radio"/>	<input type="radio"/>	YI16				
	16IR18NPT	-	11,5	16	9,52	3,4	-	1,1	1,5	<input type="radio"/>	<input type="radio"/>	<input type="radio"/>	YI16				
	16IR14NPT	-	14	16	9,52	3,4	-	0,9	1,2	<input type="radio"/>	<input type="radio"/>	<input type="radio"/>	YI16				
	16IR11,5NPT	-	18	16	9,52	3,4	-	0,8	1,0	<input type="radio"/>	<input type="radio"/>	<input type="radio"/>	YI16				
	16IR8NPT	-	27	16	9,52	3,4	-	0,7	0,8	<input type="radio"/>	<input type="radio"/>	<input type="radio"/>	YI16				
Links Left hand 	11IL27NPT	-	27	11	6,35	3,0	-	0,7	0,8	<input type="radio"/>	<input type="radio"/>	<input type="radio"/>	-	NVR..-11	152		
	11IL18NPT	-	18	11	6,35	3,0	-	0,8	1,0	<input type="radio"/>	<input type="radio"/>	<input type="radio"/>	-				
	11IL14NPT	-	14	11	6,35	3,0	-	0,8	1,0	<input type="radio"/>	<input type="radio"/>	<input type="radio"/>	-				
	16IL14NPT	-	14	16	9,52	3,4	-	0,9	1,2	<input type="radio"/>	<input type="radio"/>	<input type="radio"/>	YE16	AVR..-16	152		
	16IL11,5NPT	-	11,5	16	9,52	3,4	-	1,1	1,5	<input type="radio"/>	<input type="radio"/>	<input type="radio"/>	YE16	NVR..-16	152		
	16IL8NPT	-	8	16	9,52	3,4	-	1,3	1,8	<input type="radio"/>	<input type="radio"/>	<input type="radio"/>	YE16				

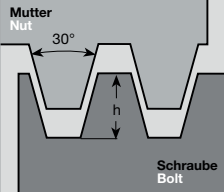
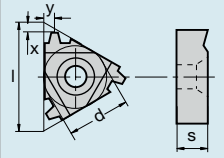

		NPTF - Vollprofil NPTF - Full Profile										Sorte Grade			Unter- lage Anvil	Passendes Werkzeug Suitable tool holder	Seite Page
		Bestellbezeichnung Ordering Code	Steigung Pitch		l	d	s	r	x	y	LCP20T	LCM25T	LWN20T				
			mm	Gang / Zoll tpi													
Rechts Right hand 	11IR18NPTF	-	18	11	6,35	3,0	-	0,8	1,0	<input type="radio"/>	<input type="radio"/>	<input type="radio"/>	-	NVR..-11	152		
	11IR14NPTF	-	14	11	6,35	3,0	-	0,8	1,0	<input type="radio"/>	<input type="radio"/>	<input type="radio"/>	-				
	16IR18NPTF	-	27	16	9,52	3,4	-	0,7	0,8	<input type="radio"/>	<input type="radio"/>	<input type="radio"/>	YI16	AVR..-16	152		
	16IR14NPTF	-	18	16	9,52	3,4	-	0,8	1,0	<input type="radio"/>	<input type="radio"/>	<input type="radio"/>	YI16	NVR..-16	152		
	16IR11,5NPTF	-	14	16	9,52	3,4	-	0,9	1,2	<input type="radio"/>	<input type="radio"/>	<input type="radio"/>	YI16				
	16IR8NPTF	-	11,5	16	9,52	3,4	-	1,1	1,5	<input type="radio"/>	<input type="radio"/>	<input type="radio"/>	YI16				

Bestellbeispiel Order example: 10 Stück pieces 11IR27NPT LCP20T

- Verfügbar ab Lager Available from stock
- Auf Anfrage Upon request

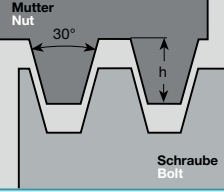
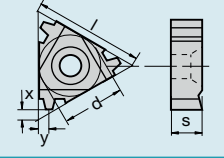

		Trapez DIN 103 - Vollprofil Trapezoidal DIN 103 - Full Profile										Sorte Grade			Unterlage Anvil	Passendes Werkzeug Suitable tool holder	Seite Page
		Steigung Pitch		l	d	s	r	x	y	LCP20T	LCM25T	LWN20T					
	Bestellbezeichnung Ordering Code	mm	Gang / Zoll tpi														
	Rechts Right hand 	11ER1,5TR	1,5	-	11	6,35	3,0	-	0,8	0,9	●	●	○		NL..-11	152	
16ER1,5TR		1,5	-	16	9,52	3,4	-	1,0	1,1	●	●	○	YE16	AL..-16	152		
16ER2,0TR		2,0	-	16	9,52	3,4	-	1,1	1,3	●	●	○	YE16				
16ER3,0TR		3,0	-	16	9,52	3,4	-	1,3	1,5	●	●	○	YE16				
22ER4,0TR		4,0	-	22	12,70	4,6	-	1,7	1,9	●	●	○	YE22	AL..-22	152		
22ER5,0TR		5,0	-	22	12,70	4,6	-	2,1	2,5	●	●	○	YE22				
27ER6,0TR		6,0	-	27	15,88	6,2	-	2,3	2,7	●	●	○	YE27	AL..-27			
Links Left hand 	16EL1,5TR	1,5	-	16	9,52	3,4	-	1,0	1,1	●	●	○	YI16	AL..-16	152		
	16EL2,0TR	2,0	-	16	9,52	3,4	-	1,1	1,3	●	●	○	YI16				
	16EL3,0TR	3,0	-	16	9,52	3,4	-	1,3	1,5	●	●	○	YI16				
	22EL4,0TR	4,0	-	22	12,70	4,6	-	1,7	1,9	●	●	○	YI22	AL..-22	152		
	22EL5,0TR	5,0	-	22	12,70	4,6	-	2,1	2,5	●	●	○	YI22				
	22EL6,0TR	6,0	-	22	12,70	4,6	-	2,3	2,7	●	●	○	YI22				
	27EL6,0TR	6,0	-	27	15,88	6,2	-	2,3	2,7	●	●	○	YI27	AL..-27	152		



Wendeschneidplatten - Innengewinde
Indexable inserts - internal threads

		Trapez DIN 103 - Vollprofil Trapezoidal DIN 103 - Full Profile										Sorte Grade			Unterlage Anvil	Passendes Werkzeug Suitable tool holder	Seite Page
		Steigung Pitch		l	d	s	r	x	y	LCP20T	LCM25T	LWN20T					
	Bestellbezeichnung Ordering Code	mm	Gang / Zoll tpi														
	Rechts Right hand 	11IR1,5TR	1,5	-	11	6,35	3,0	-	0,8	0,9	●	●	○	-	NVR..-11	152	
16IR1,5TR		1,5	-	16	9,52	3,4	-	1,0	1,1	●	●	○	YI16	AVR..-16	152		
16IR2,0TR		2,0	-	16	9,52	3,4	-	1,1	1,3	●	●	○	YI16	NVR..-16	152		
16IR3,0TR		3,0	-	16	9,52	3,4	-	1,3	1,5	●	●	○	YI16				
22IR4,0TR		4,0	-	22	12,70	4,6	-	1,7	1,9	●	●	○	YI22	AVR..-22	152		
22IR5,0TR		5,0	-	22	12,70	4,6	-	2,1	2,5	●	●	○	YI22	NVR..-22	152		
Links Left hand 	11IL1,5TR	1,5	-	11	6,35	3,0	-	0,8	0,9	●	●	○	-	NVR..-11	152		
	16IL1,5TR	1,5	-	16	9,52	3,4	-	1,0	1,1	●	●	○	YE16	AVR..-16	152		
	16IL2,0TR	2,0	-	16	9,52	3,4	-	1,1	1,3	●	●	○	YE16	NVR..-16	152		
	16IL3,0TR	3,0	-	16	9,52	3,4	-	1,3	1,5	●	●	○	YE16				
	22IL4,0TR	4,0	-	22	12,70	4,6	-	1,7	1,9	●	●	○	YE22	AVR..-22	152		
	22IL5,0TR	5,0	-	22	12,70	4,6	-	2,1	2,5	●	●	○	YE22	NVR..-22	152		

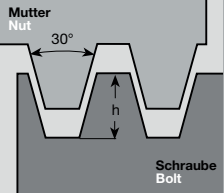
Bestellbeispiel Order example: 10 Stück pieces 11ER1,5TR LCP20T

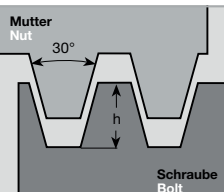

- Verfügbar ab Lager Available from stock
- Auf Anfrage Upon request

		Trapez DIN 103 - Vollprofil Trapezoidal DIN 103 - Full Profile Form V, Form V										Sorte Grade			Unterlage Anvil	Passendes Werkzeug Suitable tool holder	Seite Page
		Steigung Pitch		l	d	s	r	x	y	LCP20T	LCM25T	LWN20T					
Bestellbezeichnung Ordering Code		mm	Gang / Zoll tpi														
Rechts Right hand 	27VER6,0TR	6,0	-	27	15,88	6,0	-	1,0	3,3		●			NL...-27....V	153		
	27VER7,0TR	7,0	-	27	15,88	6,0	-	1,0	3,3		●						
	27VER8,0TR	8,0	-	27	15,88	6,0	-	1,0	3,3		●						
	27VER12,0TR	12,0	-	27	15,88	10,0	-	1,0	5,2		●						
Links Left hand 	27VEL6,0TR	6,0	-	27	15,88	6,0	-	1,0	3,3		●			NL...-27....V	153		
	27VEL7,0TR	7,0	-	27	15,88	6,0	-	1,0	3,3		●						
	27VEL8,0TR	8,0	-	27	15,88	6,0	-	1,1	3,3		●						
	27VEL10,0TR	10,0	-	27	15,88	8,0	-	1,7	4,3		●						

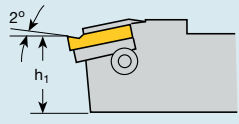

		Trapez DIN 103 - Vollprofil Trapezoidal DIN 103 - Full Profile Form U, Form U										Sorte Grade			Unterlage Anvil	Passendes Werkzeug Suitable tool holder	Seite Page
		Steigung Pitch		l	d	s	r	x	y	LCP20T	LCM25T	LWN20T					
Bestellbezeichnung Ordering Code		mm	Gang / Zoll tpi														
U-TYP U-Typ 	Rechts / right																
	22UE6,0TR	6,0	-	22	12,70	6,0	-	1,0	11,0	●	●		YE22U	AL...-22....U	153		
	22UE7,0TR	7,0	-	22	12,70	6,0	-	1,0	11,0	●	●		YE22U				
	22UE8,0TR	8,0	-	22	12,70	6,0	-	1,0	11,0	●	●		YE22U				
	27UE8,0TR	8,0	-	27	15,88	8,0	-	1,0	13,7	●	●		YE27U	AL...-27.....U	153		
	27UE9,0TR	9,0	-	27	15,88	8,0	-	1,0	13,7	●	●		YE27U				
rechts und links verwendbar usable for right and left side	Links / left																
	22UE6,0TR	6,0	-	22	12,70	6,0	-	1,0	11,0	●	●		YI22U	AL...-22....U	153		
	22UE7,0TR	7,0	-	22	12,70	6,0	-	1,0	11,0	●	●		YI22U				
	22UE8,0TR	8,0	-	22	12,70	6,0	-	1,0	11,0	●	●		YI22U				
	27UE8,0TR	8,0	-	27	15,88	8,0	-	1,0	13,7	●	●		YI27U	AL...-27.....U	153		
	27UE9,0TR	9,0	-	27	15,88	8,0	-	1,0	13,7	●	●		YI27U				

Bestellbeispiel Order example: 10 Stück pieces 27VER6,0TR LCP20T

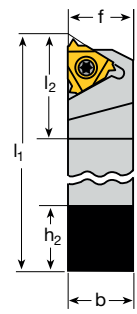
- Verfügbar ab Lager Available from stock
- Auf Anfrage Upon request

		Bestellbezeichnung Ordering Code	$b = h_2 = h_1$	f	l_1	l_2	Plattengröße Insert size
 	NL12-11	12	12	80	17,5	11	
	AL16-16	16	16	100	22	16	
	AL20-16	20	20	128,6	30	16	
	AL25-16	25	25	153,6	30	16	
	AL32-16	32	32	173,6	30	16	
	AL25-22	25	25	155,7	36	22	
	AL32-22	32	32	175,7	36	22	
	AL32-27	32	32	175,9	40	27	
	AL40-27	40	40	205,9	40	27	

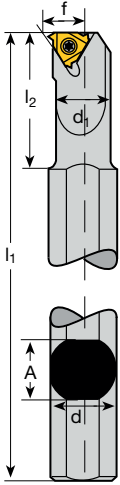
Klemmhalter, Innenbearbeitung
Tool holder, internal machining

		Bestellbezeichnung Ordering Code	A	l_1	l_2	d	d_1	f	D_{min}	Plattengröße Insert size
 <p>Halter mit Kühlmittelbohrung Tool holder with coolant</p>	NVRC10-11	18,0	180	25	20	10,0	7,3	13	11	
	NVRC13-11	18,0	180	32	20	13,0	8,9	16	11	
	NVRC13-16	18,0	180	32	20	12,7	10,3	17	16	
	NVRC16-16	18,0	180	40	20	16,0	11,5	20	16	
	NVRC16D-16	15,2	150	32	16	16,0	11,3	20	16	
	AVRC20-16	18,0	180	40	20	20,0	13,4	24	16	
	AVRC25-16	29,0	250	60	32	25,0	16,3	29	16	
	AVRC25D-16	22,6	200	45	25	24,6	16,1	29	16	
	AVRC32-16	29,0	250	60	32	32,0	19,6	36	16	
	AVRC40-16	36,0	300	60	40	40,0	23,8	44	16	
	NVRC20-22	18,0	180	50	20	20,0	15,6	27	22	
	AVRC25-22	29,0	250	60	32	25,0	17,4	32	22	
	AVRC32-22	29,0	250	60	32	32,0	21,5	39	22	
	AVRC40-22	36,0	300	60	40	40,0	25,8	47	22	
	AVRC50-27	45	350	75	50	50,0	31,4	58	27	
AVRC60-27	54	400	75	60	60,0	36,4	69	27		

Die Halter der Tabellen sind Rechtsausführung.

Für Linksausführung bitte -LH an die Bezeichnung anfügen.

Alle Halter haben einen 1,5° Steigungswinkel. Andere Steigungswinkel für AL.. und AVRC..-Halter durch Wechsel der Unterlegplatte (siehe Seite 154). NVRC-Halter haben keine Unterlagsplatte.



Anmerkung: Außen- und Innenhalter auch mit Spannfinger "Typ C" auf Anfrage erhältlich (z.B.: NVRC16-16C)

The above holders are right hand execution.

To obtain left hand execution, please add LH to the ordering code.

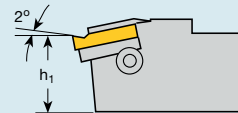

All holders have a 1,5° helix angle. Using AL.. and AVRC..-holders helix angle can be varied by changing the anvil (please refer to page 154). NVRC holders are without anvil.

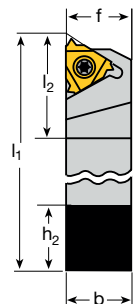
Notice: external and internal holder also with clamping finger "type C", available on demand (e.g.: NVRC16-16C)

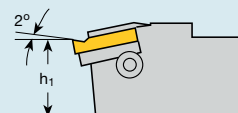

								
		Bestellbezeichnung Ordering Code	$b = h_2 = h_1$	f	l_1	l_2	Plattengröße Insert size	
		NL32-27V-6	32	32	170	40	27	
		NL32-27V-8	32	34,1	170	40	27	
		NL32-27V-10	32	35,8	170	40	27	
		NL40-27V-6	40	40,0	200	40	27	
		NL40-27V-8	40	42,1	200	40	27	
		NL40-27V-10	40	43,8	200	40	27	

Wendeschneidplatte siehe Seite 151 Form V
 Insert see page 151 Form V

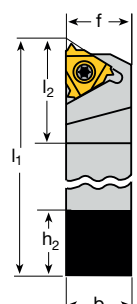
Klemmhalter, Außenbearbeitung
 Tool holder, external machining

							
		Bestellbezeichnung Ordering Code	$b = h_2 = h_1$	f	l_1	l_2	Plattengröße Insert size
		AL25-22U	25	25	178,4	38	22
		AL32-22U	32	32	178,4	38	22
		AL40-22U	40	40	208,4	38	22
		AL25-27U	25	25	179,1	40	27
		AL32-27U	32	32	179,1	40	27
		AL40-27U	40	40	209,1	40	27
		AL50-27U	50	50	259,1	40	27

Wendeschneidplatte siehe Seite 151 Form U
 Insert see page 151 Form U

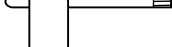
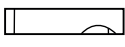
Klemmhalter Tool holder	Plattengröße Insert size	Klemmschraube Clamp screw	Schraube + Scheibe Screw + Washer	Schlüssel Key	Unterlagsplatte Anvil	
						
		Bestellbezeichnung Ordering Code			RH/in LH	LH/ in RH
NVRC	11	SN11T	-	V02-T-0800	-	-
NVRC	16	SN16T	-	V02-T-1000	-	-
NVRC	22	SN22T	-	V02-T-2000	-	-
"Standard"	16	SA16T	SY16T	V02-T-1000	YE16	YI16
"Standard"	22	SA22T	SY22T	V02-T-2000	YE22	YI22
(AL..., AV...)	27	SA27T	SY27T	V02-T-2500	YE27	YI27
Standard mit Klemmfinger	16	SA16T/C3	SY16T	V02-T-1000	YE16	YI16
Standard mit Klemmfinger	22	SA22T/C4	SY22T	V02-T-2000	YE22	YI22
Standard with clamping finger	27	SA27T/C5	SY27T	V02-T-2500	YE27	YI27
U - Type	22	SA22T	SY22T	V02-T-2000	YE22U	YI22U
	27	SA27T	SY27T	V02-T-2500	YE27U	YI27U
V - Type	27V	SN27T	-	V02-T-3000	-	-

Unterlagsplatten-Sortiment
Anvil sets

Wir empfehlen Ihnen diese Sortimente, damit Sie jederzeit für alle Bearbeitungsfälle gerüstet sind.
We recommend you to buy these kits in order to have on hand the right anvil for any job at any time.

Unterlagsplatte Anvil	Bestellnummer Ordering code	Das Sortiment beinhaltet je 1 Stück The set includes 1 of each
16	ABY16	YE16-2P, 1P, 1N, 2N, 3N, YI16-2P, 1P, 1N, 2N, 3N
22	ABY22	YE22-2P, 1P, 1N, 2N, 3N, YI22-2P, 1P, 1N, 2N, 3N
27	ABY27	YE27-2P, 1P, 1N, 2N, 3N, YI27-2P, 1P, 1N, 2N, 3N
22U	ABY22U	YE22U-2P, 1P, 1N, 2N, 3N, YI22-2P, 1P, 1N, 2N, 3N
27U	ABY27U	YE27U-2P, 1P, 1N, 2N, 3N, YI22-2P, 1P, 1N, 2N, 3N

Bestellbeispiele Ordering example: 1 Stück AL25-16 (... rechte Ausführung) 1 piece AL25-16 (...right hand execution)
1 Stück AL25-16LH (... linke Ausführung) 1 piece AL25-16LH (... left hand execution)

Gewinde-Schneidstoffsorten, Übersicht
Thread turning grades overview

Sorte Grade	ISO	Anwendungsbereich Range of applications	Werkstoffgruppe Group of materials						Bearbeitungsverfahren Processing method					
			P Stahl Steel	M Rostfrei Stainless	K Grauguss Iron	N NE-Metalle (Al, etc.) Non ferrous metals	S Hochwarmfest High temper- ature materials	H Harte Werkstoffe Hard mate- rials	T Drehen Turning	M Fräsen Milling	D Bohren Drilling	S Gewinde- bearbeitung Threading	G Einstechen Grooving	P Abstechen Parting
LCP20T	HC-P20		■	□							●			
LCM25T	HC-M20		□	■							●			
	HC-K20				■						●			
LWN20T	HC-N20					■	□				●			
Anwendungsschwerpunkt Application peak Gesamtbereich nach ISO 513 Full range to ISO 513			■ Hauptanwendung Main application □ Weitere Anwendung Further applications						● Standardsorte Standard grade					

Hauptsorten beschichtet

● LCP20T (HC-P20)

Hauptsorte für die Stahlbearbeitung. Hohe Bruchfestigkeit auch bei ungünstigen Bedingungen.
Feinstkornsubstrat mit dünner TiAlN-Beschichtung.

● LCM25T (HC-M20, HC-K20)

Hauptsorte für die Rostfreibearbeitung.
Äußerst gut geeignet für die Bearbeitung von säurebeständigen Materialien.

● LWN20T (HC-N20)

Unbeschichtete K20 Feinkornsorte für die Bearbeitung von NE-Metallen, Aluminium, Titan und hitzebeständige Legierungen.

Main grade coated

● LCP20T (HC-P20)

Main grade for steel machining. High breaking strength also on bad conditions.
Micro grain substrate with thin TiAlN coating.

● LCM25T (HC-M20, HC-K20)

Main grade for stainless machining.
Extremely good applicable for the machining of acid proofed materials.

● LWN20T (HC-N20)

Uncoated K20 fine grain grade for the machining of non ferrous metals, aluminium, titanium and heat resistant alloys.

Arbeitsmethoden beim Gewindedrehen
Thread turning methods

Außen Rechtsgewinde
External thread right hand

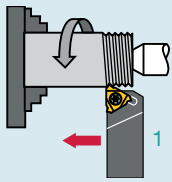

Platte und Halter rechts,
 b: Standard
 Insert and holder right hand,
 b: regular

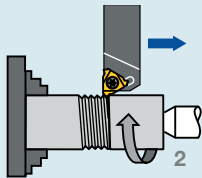

Platte und Halter links,
 b: Umgekehrt
 Insert and holder left hand,
 b: reverse

Außen Linksgewinde
External thread left hand

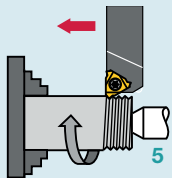

Platte und Halter links,
 b: Standard
 Insert and holder left hand,
 b: regular

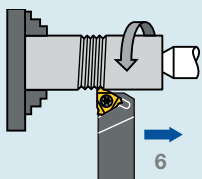

Platte und Halter rechts,
 b: Umgekehrt
 Insert and holder right hand,
 b: reverse

Innen Rechtsgewinde
Internal thread right hand

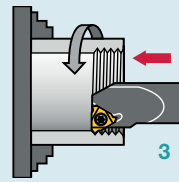

Platte und Halter rechts,
 b: Standard
 Insert and holder right hand,
 b: regular

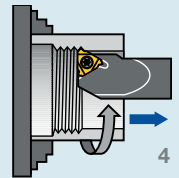

Platte und Halter links,
 b: Umgekehrt
 Insert and holder left hand,
 b: reverse

Innen Linksgewinde
Internal thread left hand

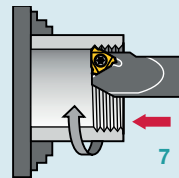

Platte und Halter links,
 b: Standard
 Insert and holder left hand,
 b: regular

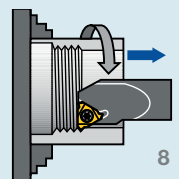

Platte und Halter rechts,
 b: Umgekehrt
 Insert and holder right hand,
 b: reverse

Flankenfreiwinkel α Flank clearance angle α :

Im Klemmhalter festgeschraubte Platten sind zur Erzeugung des Freiwinkels nach vorne geneigt, (10° Neigung bei Außen-Klemmhaltern, 15° Neigung bei Innen-Klemmhaltern). Da der Freiwinkel α je Flankenwinkel Φ variiert, geben wir Ihnen nebenstehend eine Formel zur Berechnung von α und auf Seite 156 einige technische Beispiele, woraus hervor geht, dass die Einstellung des korrekten Steigungswinkels (mittels Unterlegplatten) sehr wichtig ist, vor allem bei Gewinden mit kleinen Flankenwinkeln, damit die Platte auf keine der beiden Seiten drückt.

The tool holders are designed to tilt the insert when seated in the holder, (10° for external, 15° for internal tooling).

As the flank clearance angle α varies depending on the enclosed flank angle Φ , we give here a formula to calculate α and on page 156 some examples which show the importance of a correct adjustment of the helix angle by the help of anvils, especially in profiles with small enclosed flank angles to avoid rubbing of the insert cutting edge on the workpiece.

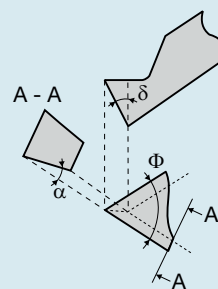
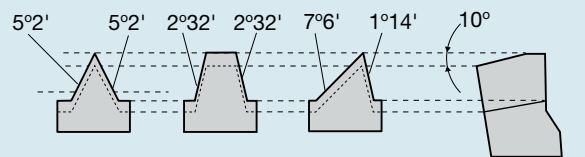

$$\alpha = \arctan(\sin \alpha / 2 \times \tan \delta)$$

wobei: α = Flankenfreiwinkel
 where: Flank clearance angle
 δ = Neigungswinkel
 Tilt angle
 Φ = Flankenwinkel
 Enclosed flank angle

Zustellungsmethoden
Infeed methods

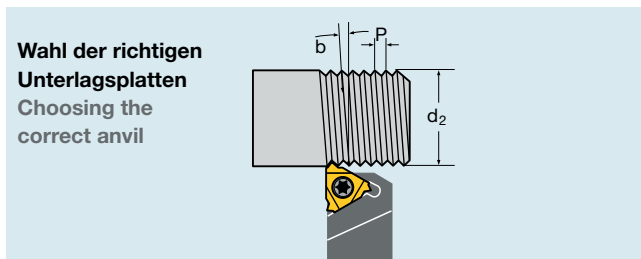
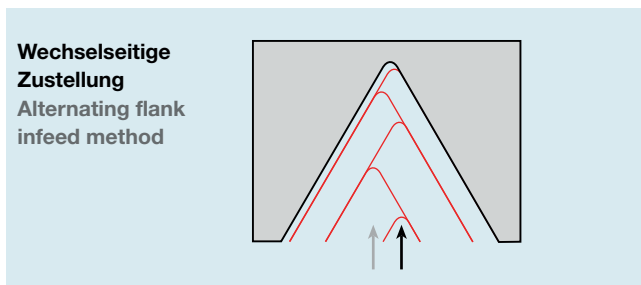
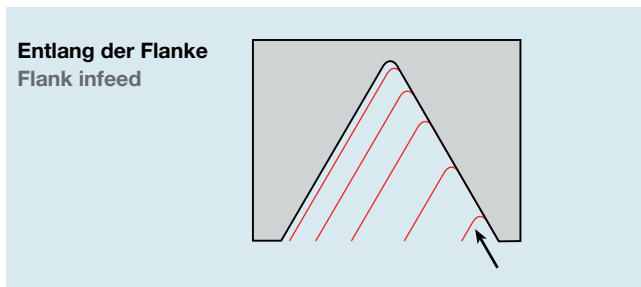
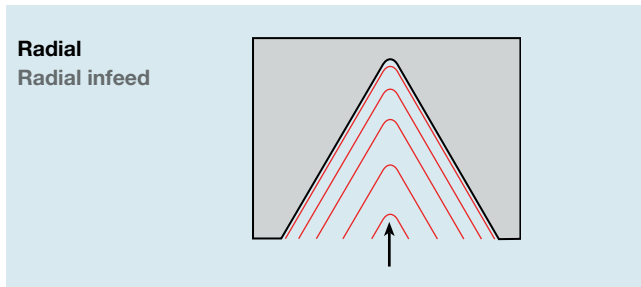

Der Steigungswinkel¹⁾
 Formel zur Berechnung:

$$\beta = \arctan \frac{P}{\pi \times d_2} \quad (\text{vereinfacht: } \beta = \frac{P}{d_2} \times 20)$$

 wobei: β = Steigungswinkel [°]
 P = Gewindesteigung [mm]
 d₂ = Flankendurchmesser [mm]

The Helix Angle¹⁾
 Formula for it's calculation:

$$\beta = \arctan \frac{P}{\pi \times d_2} \quad (\text{simplified: } \beta = \frac{P}{d_2} \times 20)$$

 where: β = Helix angle [°]
 P = pitch [mm] (use lead for multi-start threads)
 d₂ = pitch diameter [mm]

Radial

Die radiale Zustellung ist die einfachste und gängigste Methode. Zustellung senkrecht zur Drehachse. Spanabhebende Bearbeitung auf beiden Flanken des Profils. Die radiale Zustellung wird empfohlen:
 – bei Steigung kleiner als 1,0 mm
 – bei kurzspanenden Werkstoffen
 – bei Werkstoffen, die zur Kaltverfestigung neigen

Radial infeed

Radial infeed is the simplest and most popular method. The feed is perpendicular to the turning axis, and both flanks on the insert perform the cutting operation. Radial infeed is recommended:
 – when the pitch is smaller than 1.0 mm
 – for materials with short chips
 – for materials having cold hardening tendency

Entlang der Flanke

ist zu empfehlen:
 – bei Steigung größer als 1,0 mm. Bei radialer Zustellung wäre die Schneidkante zu lang, was zum Rattern führen würde.
 – Bei TRAPEZOIDAL und ACME-Gewinde, weil das Spanen an drei Schneidkanten für den Spanfluß von Nachteil ist.

Flank infeed

is recommended:
 – when the thread pitch is more than 1.0 mm. Using the radial method, the effective cutting edge length is too large, resulting in chatter
 – for TRAPEZOIDAL and ACME thread. The radial method result in three cutting edges, making chip flow very difficult

Wechselseitige Zustellung

Besonders empfohlen bei sehr großen Steigungen, bzw. bei langspanenden Werkstoffen. Von Vorteil ist Aufteilung der Bearbeitungen entlang beider Flanken und der gleichmäßige Verschleiß auf beiden Schneidkanten. Wegen der aufwendigen Programmierung ist diese Zustellmethode nicht auf allen Maschinen möglich.

Alternating flank infeed method

Use of the alternate flank infeed method is recommended especially in large pitches, and for materials with long chips. This method divides the work equally on both flanks, resulting in equal wear along the cutting edges. Alternate flank infeed requires more complicated programming and is not available on all lathes.

¹⁾ Der Steigungswinkel kann auch mit Hilfe des Diagramms auf Seite 158 ermittelt werden.
¹⁾ The helix angle can also be found from the graph on page 158.

Die Auswahl der richtigen Unterlagsplatte erfolgt entsprechend Tabelle auf Seite 158.
 To determine the correct anvil use the table on page 158.

Steigungswinkel
Helix angle

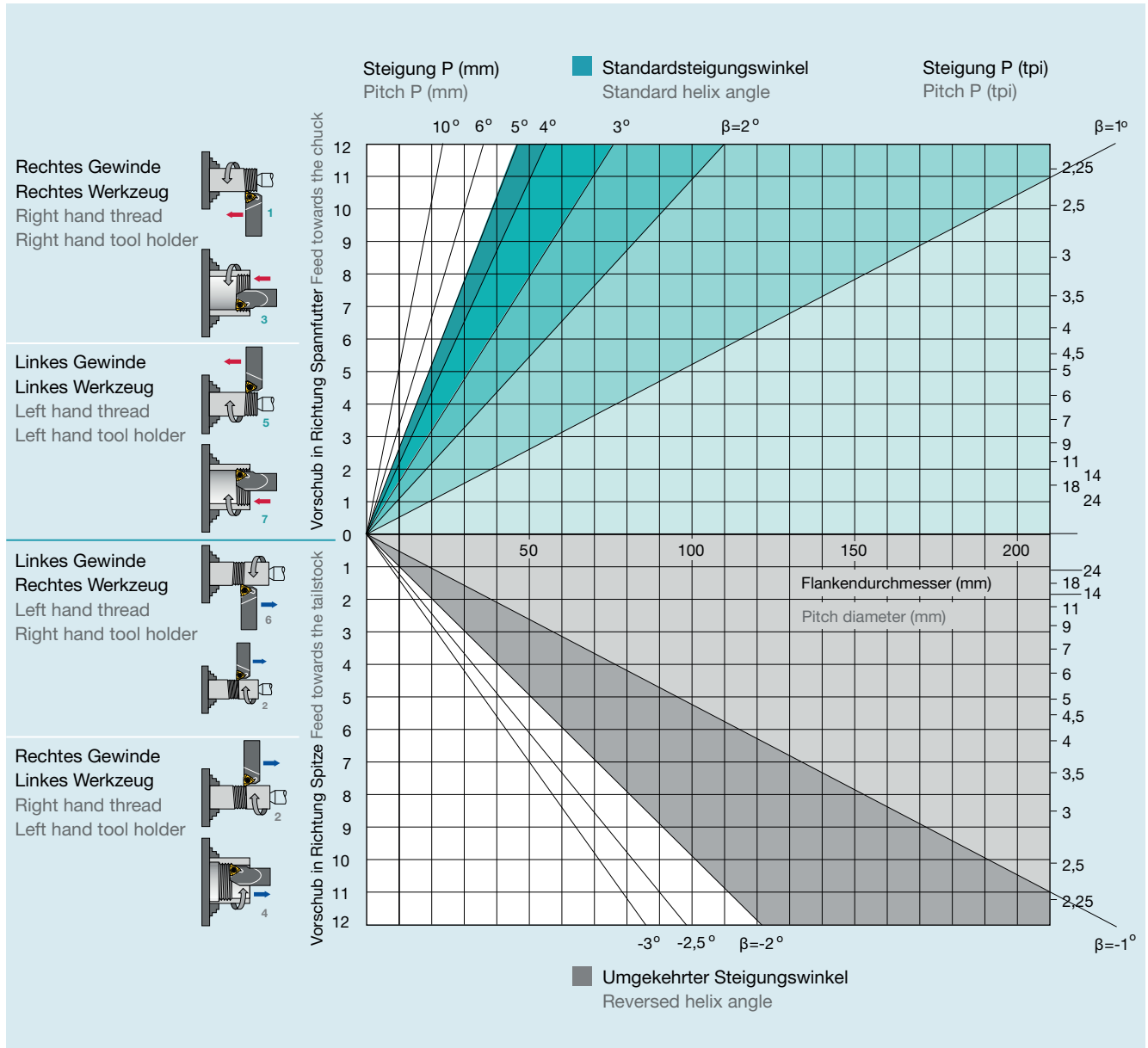

Unterlagsplatten
Anvils

Steigungswinkel Helix angle		4,5	3,5	2,5	1,5	0,5	0	-0,5	-1,5
Platte I = Insert I =	Halter Holder	Bestellbezeichnung Ordering Code							
16	ER/IL	YE16-3P	YE16-2P	YE16-1P	YE16	YE16-1N	YE16-1,5N	YE16-2N	YE16-3N
16	EL/IR	YI16-3P	YI16-2P	YI16-1P	YI16	YI16-1N	YI16-1,5N	YI16-2N	YI16-3N
22	ER/IL	YE22-3P	YE22-2P	YE22-1P	YE22	YE22-1N	YE22-1,5N	YE22-2N	YE22-3N
22	EL/IR	YI22-3P	YI22-2P	YI22-1P	YI22	YI22-1N	YI22-1,5N	YI22-2N	YI22-3N

Bearbeitungsbeispiele
Machining examples

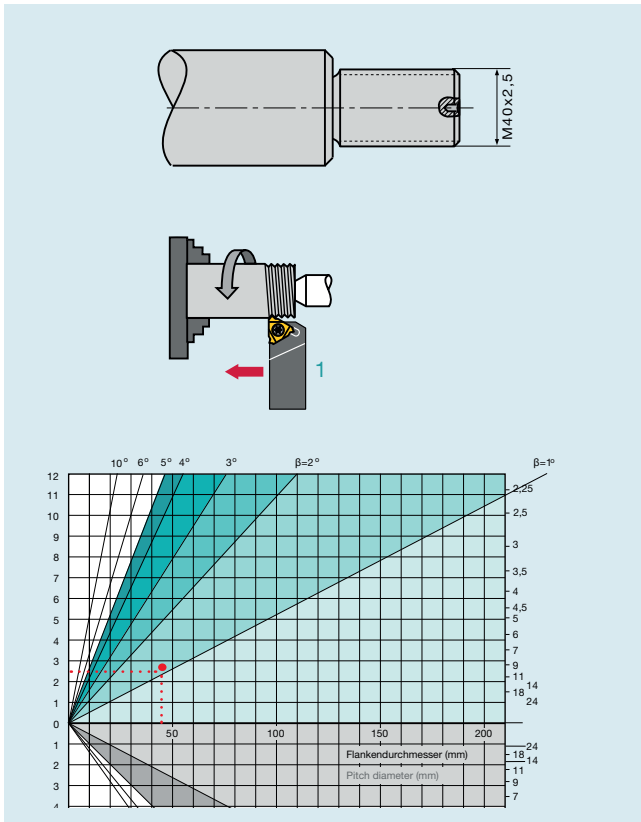

Gewinde: ISO-metrisches Gewinde, M40 x 2,5 außen rechts
 Werkstoff: 42CrMo4

Gewählte Arbeitsmethode: Nr. 1, Vorschub zum Spannfutter
 Klemmhalter: AL25-16

Wendeplatte: 16ER2,5ISO

Boehlerit Sorte: LCP20T

Ermittlung des Steigungswinkels und Wahl der Unterlagsplatte:
 Aus der Graphik Seite 158 wird ein Steigungswinkel β zwischen 1° und 2° abgelesen. Aus der Tabelle auf Seite 158 wird diesem Steigungswinkel die Unterlagsplatte YE16 zugeordnet.

Schnittgeschwindigkeit und Anzahl der Durchgänge werden aus den Angaben der Tabellen auf den Seiten 160-161 entnommen:
 v_C : 120 m/min, Durchgänge: 10

Thread: ISO-metric M40 x 2,5 external right hand

Material: 42CrMo4

Chosen working method: No1, feed towards the chuck

Tool holder: AL25-16

Insert: 16ER2,5ISO

Boehlerit grade: LCP20T

Determination of the helix angle and choice of the correct anvil:

From the diagram on page 158 a helix angle β between 1° and 2° is found. To this helix angle corresponds anvil YE16 in the table on page 158. Cutting speed and number of passes are taken from the tables on pages 160-161:

v_C : 120 m/min, Number of passes: 10

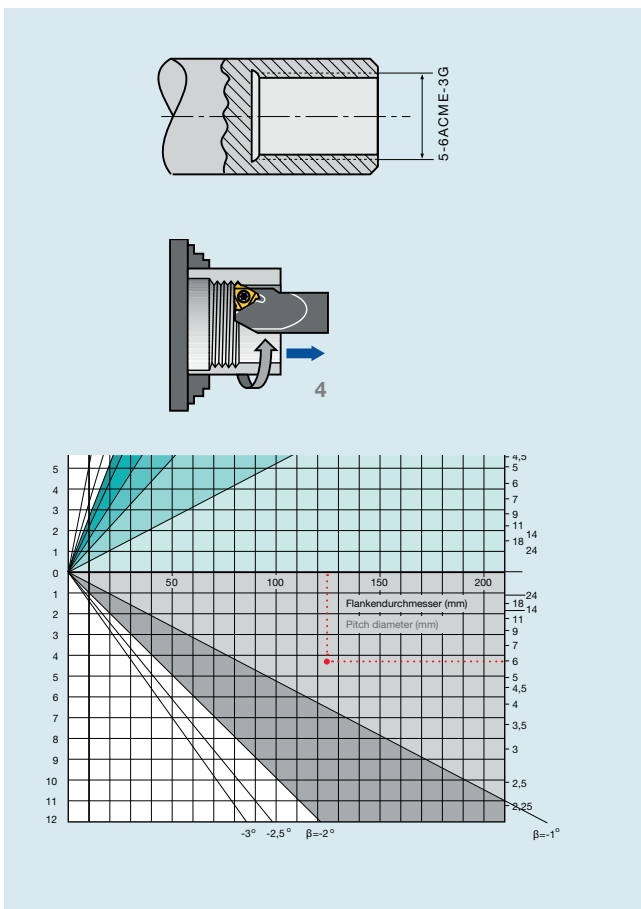

Gewinde: ACME innen rechts
 Steigung: 6 tpi (Gänge pro Zoll)

Bohrungsdurchm.: 5"

Werkstoff: NIRO austenitisch

Gewählte Arbeitsmethode: Nr.4, Vorschub weg vom Spannfutter (zur besseren Spanabfuhr)

Klemmhalter: AVR40-22LH

Wendeplatte: 22IL6ACME

Boehlerit Sorte: LCM25T

Ermittlung des Steigungswinkels und Wahl der Unterlagsplatte:
 Aus der Graphik Seite 158 wird ein Steigungswinkel β zwischen 0° und 1° abgelesen. Aus der Tabelle auf Seite 158 wird diesem Steigungswinkel die Unterlagsplatte YE22-2N zugeordnet.

Schnittgeschwindigkeit und Anzahl der Durchgänge werden aus den Angaben der Tabellen auf den Seiten 160-161 entnommen:
 v_C : 150 m/min, Durchgänge: 18

Thread: ACME internal right hand

Pitch: 6 tpi

Diameter of hole: 5"

Material: Stainless austenitic

Chosen working method: No.4, feed off the chuck (for better evacuation of the chips)

Tool holder: AVR40-22LH

Insert: 22IL6ACME

Boehlerit grade: LCM25T

Determination of the helix angle and choice of the correct anvil:

From the diagram on page 158 a helix angle β between 0° and 1° is found. To this helix angle corresponds anvil YE22-2N in the table on page 158. Cutting speed and number of passes are taken from the tables on pages 160-161:

v_C : 150 m/min, Number of passes: 18

Maßnahmen bei Bearbeitungsproblemen, Gewindedrehen
Options against machining problems, thread turning

	Problem							
	Extremer Freiflächenverschleiß Increased insert flank wear	Ungleichmäßiger Schneidkantenverschleiß Uneven cutting edge wear	Extreme plastische Verformung Extreme plastic deformation	Plattenbruch Cutting edge breakage	Aufbauschneidenbildung Built-up edge	Zu flaches Gewindeprofil Thread profile is too shallow	Schlechte Oberflächengüte Poor surface quality	
Abhilfe								
Option								
HM-Verschleißfestigkeit Carbide wear resistance	↑		↑		↑			
HM-Zähigkeit Carbide toughness				↑				
Schnittgeschwindigkeit Cutting speed	↓		↓		↑		↓	
Vorschub Feed			↓	↓				
Zahl der Durchgänge Number of passes			↑	↑				
Flankenzustellung Flank infeed method		↔					↔	
Unterlagsplatte Anvil		↔					↔	
Schneidkantenhöhe Height of cutting edge						↔		
Spannung Fixation					↔			
Rohlingsmaß Size of the blank						↔		
Kühlung Cooling	↑		↑	↔				
Schneidplattenwechsel Change of the cutting edge						↔		
<p>↑ erhöhen, vergrößern increase</p> <p>↓ vermindern, verkleinern reduce</p> <p>↔ optimieren, kontrollieren optimize</p>								

Anzahl der Durchgänge
Number of passes

Steigung Pitch	mm	0,50	0,75	1,00	1,25	1,50	1,75	2,00	2,50	3,00	3,50	4,00	4,50	5,00	5,50	6,00	8,00
	Gänge/Zoll tpi	48	32	24	20	16	14	12	10	8	7	6	5,5	5	4,5	4	3
Anzahl Durchgänge Number of passes		4-6	4-7	4-8	5-9	6-10	7-12	7-12	8-14	9-16	10-18	11-18	11-19	12-20	12-20	12-20	15-24

Schnittdatenrichtwerte Gewindedrehen
Cutting data standard value, thread turning

Werkstoffgruppe Material group	Gliederung der Werkstoff-Hauptgruppen und Kennbuchstaben Mainworkpiece material groups and their characteristics letters		Brinell Härte Brinell hardness HB			
				LCP20T	LCM25T	LWN20T
	Werkstoff Material			v _C (m/min)	v _C (m/min)	v _C (m/min)
P	Unlegierter Stahl ¹⁾ Unalloyed steel ¹⁾	ca. 0,15%C gegläht annealed	125	115 - 190		
		ca. 0,45 %C gegläht annealed	150	100 - 175		
		ca. 0,75 %C vergütet heat treated	170	90 - 165		
	Niedrig legierter Stahl ¹⁾ Low-alloy steel ¹⁾	geglüht annealed	180	100 - 180		
		vergütet heat treated	275	75 - 140		
		vergütet heat treated	350	70 - 135		
	Hochlegierter Stahl und hochlegierter Werkzeugstahl ¹⁾ High-alloy steel and high alloy tool steel ¹⁾	geglüht annealed	200	80 - 120		
		gehärtet und angelassen	325	50 - 100		
		annealed	200	80 - 120		
	Stahlguss ¹⁾ Steel cast ¹⁾	gehärtet und angelassen	325	50 - 100		
ferritisch/martensitisch gegläht ferritic/martensitic annealed		200	70 - 130			
martensitisch vergütet martensitic hardened and temp.		225	60 - 120			
martensitisch vergütet martensitic hardened and temp.		225	60 - 120			
M	Nichtrostender Stahl ¹⁾ ferritisch Stainless steel ¹⁾ ferritic	ungehärtet	200	70 - 130	70 - 150	
		gehärtet	330	60 - 115	60 - 125	
		unhardenable	200	70 - 130	70 - 150	
	Nichtrostender Stahl ¹⁾ austenitisch Stainless steel ¹⁾ austenitic	gehärtet	300	60 - 115	60 - 125	
		austenitisch	180	90 - 140	90 - 160	
		Duplex	200	40 - 110	40 - 120	
	Edelstahlguss ¹⁾ ferritisch Special steel cast ¹⁾ ferritic	austenitisch	180	90 - 140	90 - 160	
		Duplex	200	40 - 110	40 - 120	
		ungehärtet	200	90 - 120	90 - 150	
	Edelstahlguss ¹⁾ austenitisch Special steel cast ¹⁾ austenitic	gehärtet	330	65 - 110	65 - 120	
		unhardenable	200	90 - 120	90 - 150	
		gehärtet	330	65 - 110	65 - 120	
K	Grauguss Grey cast iron	perlitisch/ferritisch perlitic/ferritic	180	70 - 130		
		perlitisch (martensitisch) perlitic (martensitic)	260	60 - 115		
	Gusseisen mit Kugelgraphit Nodular graphite cast iron	ferritisch ferritic	160	125 - 160		
		perlitisch perlitic	260	90 - 120		
	Temperguss Malleable cast iron	ferritisch ferritic	130	60 - 70		
		perlitisch perlitic	230	60 - 145		
N	Aluminium-Legierungen schmiedeeisern Aluminium alloys forge ironed	gewalzt nicht aushärtbar rolled, not hardenable	60	100 - 365		100 - 250
		gegossen, nicht aushärtbar casted, not hardenable	75	200 - 400		80 - 120
	Aluminium-Legierungen Aluminium alloys	Guss Si 13-22% cast Si 13-22%	130	60 - 180		50 - 120
		Kupfer und Kupferlegierungen (Bronze/Messing) Copper and copper alloys (Bronze/Brass)	Messing	90	80 - 225	
	Bronze und bleifreies Kupfer Brass	Bronze und bleifreies Kupfer	100	80 - 255		70 - 170
		Bronze, non leaded copper				
S	Warmfeste Legierungen Heat resistant alloys	Fe-Basis vergütet heat treated	200	45 - 60		30 - 50
		Fe-basis gealtert aged	280	30 - 50		25 - 40
		Ni- oder Co-Basis vergütet heat treated	250	20 - 30		20 - 30
		Ni- or Co-based gealtert aged	350	15 - 25		15 - 25
	Titanlegierungen Titanium alloys	Reintitan Pure titanium	400Rm	140 - 170		60 - 100
		Alpha + Beta-Legierungen, ausgehärtet Alpha- and Beta-alloys hardened	1050Rm 1050Rm	50 - 70 50 - 70		40 - 60 40 - 60
H	Gehärteter Stahl Hardened steel	gehärtet und angelassen	45-50HRC	45 - 60		
		gehärtet und angelassen	51-55HRC	40 - 50		
		gehärtet und angelassen	45-50HRC	45 - 60		
		gehärtet und angelassen	51-55HRC	40 - 50		

¹⁾ und Stahlguss
and cast steel

Das Farbleitsystem Colour identification system	163
Werkstückstoff-Vergleichstabelle Comparison table of materials	164
Vergleich ISO – zu ANSI-Kennzeichnung Comparison ISO and ANSI designation	172
Härte-Vergleichstabelle Hardness-comparison table	175

Steigern Sie Ihre Effizienz mit Colorguide, dem perfekten Farbleitsystem zur Auswahl der richtigen Wendeschneidplatte. Dieser Wegweiser durch die Vielfalt, den Sie auf dem Etikett jeder Wendeschneidplattenschachtel finden, gibt Ihnen rasch und verlässlich Auskunft über die Eignung einer bestimmten Wendeschneidplatte für den jeweiligen Bearbeitungsfall. Colorguide spart Zeit und hilft Fehlanwendungen zu vermeiden.

Increase your efficiency with colorguide, the perfect colour identification system for finding the right indexable insert. This guide through the variety which you will find on the label of each indexable inserts box informs you quickly and reliably about the suitability of this indexable insert for the intended machining operation. colorguide saves time and helps to avoid wrong applications.

In einem Raster, der senkrecht in sechs mit Farben gekennzeichnete Materialhauptgruppen (nach VDI 3323) und waagrecht in drei Bearbeitungsstufen (von grob ROUGH über mittel MEDIUM nach fein FINE) geteilt ist, geben die aufgedruckten Symbole Auskunft über den oder die Anwendungsbereiche einer bestimmten Wendeschneidplatte.

Am neben gezeigten Beispiel:

CNMG 120412-MP in der Sorte LCP25T ist hauptsächlich für die mittlere Bearbeitung von Stahl und daneben auch für die mittlere Bearbeitung von nichtrostendem Stahl im kontinuierlichen Schnitt geeignet.

Symbols printed in a grid which is vertically organized into six main material groups represented by colours (acc. to VDI 3323) and horizontally by three levels of machining (ROUGH - MEDIUM - FINE) define the field(s) of application of the indexable insert.

For example, the label besides tells you:

CNMG 120412-MP in grade LCP25T is primarily suitable for medium turning of steel but also for turning of stainless steel, both in continuous cut.

In die Materialhauptgruppen fallen die nachstehend angeführten Werkstoffgruppen:

- Stahl: Automaten-, Einsatz-, Vergütungs- und Baustähle, weißer Temperguss
- Nichtrostender Stahl: Ferritische Cr-Stähle, martensitische CrNi-Stähle, austenitische CrNi-Stähle
- Eisenguss: Grauguss, Temperguss, Sphäroguss, Sinterisen
- Nichteisen-Metalle: Al-Knet- und Al-Gusslegierungen, auch Weichkunststoffe, faserverstärkte Kunststoffe
- Hochwarmfeste Legierungen: Hitzebeständige Stähle, Ni-/Co-Basis-Legierungen, Ti-Legierungen
- Gehärtete Werkstoffe: Gehärtete Stähle (45 HRC), Einsatzstähle, Schalenhartguss

The main material groups include the following materials:

- Steel: Free cutting steels, case hardening steels, heat treatment steels, constructional steels, white malleable cast iron
- Stainless steels: Ferritic Cr-steels, martensitic CrNi-steels, austenitic CrNi-steels
- Cast iron: Grey cast iron, malleable cast iron, spheroidal cast iron, sintered iron
- Non-ferrous metal: Al wrought and Al cast alloys, also soft plastics and fiber-reinforced plastics
- High-temperature alloys: Heat resistant steels, alloys on Ni/Co basis, Ti alloys
- Hardened materials: Hardened steels (45 HRC), case hardened steels, clear chill castings.



Werkstoffgruppen Material groups			
	Rough	Medium	Fine
Stahl Steel	Blue	Light Blue	Very Light Blue
Nichtrostender Stahl Stainless steel	Yellow	Light Yellow	Very Light Yellow
Eisenguss Iron casting	Red	Light Red	Very Light Red
Nichteisen-Metalle Non-ferrous metals	Green	Light Green	Very Light Green
Hochwarmfeste Legierungen High temperature alloys	Orange	Light Orange	Very Light Orange
Gehärtete Werkstoffe Hardened materials	Grey	Light Grey	Very Light Grey

Bearbeitungsarten Machining mode			
	Rough	Medium	Fine
Vorschub f_n (mm) Feed f_n (mm)	0,6 – 1,2	0,25 – 0,6	0,05 – 0,25
Schnitttiefe a_p (mm) Depth of cut a_p (mm)	5 – 15	1,5 – 5	0,1 – 1,5

Anwendungsbereiche Application area		
	kontinuierlicher Schnitt Continuous cut	unterbrochener Schnitt Interrupted cut
Hauptanwendung Main application	●	▶
Nebenanwendung Other application	○	▷

Werkstückstoff - Vergleichstabelle
Comparison table of materials to be machined

Werkstoff-Gruppe Material group	Deutschland Germany		Großbritannien Great Britain		Frankreich France	Italien Italy
	W-Nr.	DIN	BS	EN	AFNOR	UNI
P	Baustahl und Konstruktionsstahl Constructional steels					
	1.0401	C15	080M15	-	CC12	C15C16
	1.0402	C22	050A20	2C	CC20	C20C21
	1.0501	C35	060A35	-	CC35	C35
	1.0503	C45	080M46	-	CC45	C45
	1.0535	C55	070M55	-	-	C55
	1.0601	C60	080A62	43D	CC55	C60
	1.0715	9SMn28	230M07	-	S250	CF9SMn28
	1.0718	9SMnPb28	-	-	S250Pb	CF9SMnPb28
	1.0722	10SPb20	-	-	10PbF2	CF10SPb20
	1.0726	35S20	212M36	8M	35MF4	-
	1.0736	9SMn36	240M07	1B	S300	CF9SMn36
	1.0737	9SMnPb36	-	-	S300Pb	CF9SMnPb36
	1.0904	55Si7	250A53	45	55S7	55Si8
	1.0961	60SiCr7	-	-	60SC7	60SiCr8
	1.1141	Ck15	080M15	32C	XC12	C16
	1.1157	40Mn4	150M36	15	35M5	-
	1.1158	Ck25	-	-	-	-
	1.1167	36Mn5	-	-	40M5	-
	1.1170	28Mn6	150M28	14A	20M5	C28Mn
	1.1183	Cf35	060A35	-	XC38TS	C36
	1.1191	Ck45	080M46	-	XC42	C45
	1.1203	Ck55	070M55	-	XC55	C50
	1.1213	Cf53	060A52	-	XC48TS	C53
	1.1221	Ck60	080A62	43D	XC60	C60
	1.1274	Ck101	060A96	-	-	-
	1.3401	X120Mn12	Z120M12	-	Z120M12	XG120Mn12
	1.3505	100Cr6	534A99	31	100C6	100Cr6
	1.5415	15Mo3	1501-240	-	15D3	16Mo3KW
	1.5423	16Mo5	1503-245-420	-	-	16Mo5
	1.5622	14Ni6	-	-	16N6	14Ni6
	1.5662	X8Ni9	1501-509;510	-	-	X10Ni9
	1.5680	12Ni19	-	-	Z18N5	-
	1.5710	36NiCr6	640A35	111A	35NC6	-
	1.5732	14NiCr10	-	-	14NC11	16NiCr11
	1.5752	14NiCr14	655M13; 655A12	36A	12NC15	-
	1.6511	36CrNiMo4	816M40	110	40NCD3	38NiCrMo4(KB)
	1.6523	21NiCrMo2	805M20	362	20NCD2	20NiCrMo2
	1.6546	40NiCrMo22	311-Type 7	-	-	40NiCrMo2(KB)
	1.6582	34CrNiMo6	817M40	24	35NCD6	35NiCrMo6(KB)
	1.6587	17CrNiMo6	820A16	-	18NCD6	-
	1.6657	14NiCrMo134	832M13	36C	-	15NiCrMo13
	1.7015	15Cr3	523M15	-	12C3	-
	1.7033	34Cr4	530A32	18B	32C4	34Cr4(KB)
	1.7035	41Cr4	530M40	18	42C4	41Cr4
1.7045	42Cr4	-	-	-	-	
1.7131	16MnCr5	(527M20)	-	16MC5	16MnCr5	
1.7176	55Cr3	527A60	48	55C3	-	
1.7218	25CrMo4	1717CDS110	-	25CD4	25CrMo4(KB)	
1.7220	34CrMo4	708A37	19B	35CD4	35CrMo4	
1.7223	41CrMo4	708M40	19A	42CD4TS	41CrMo4	
1.7225	42CrMo4	708M40	19A	42CD4	42CrMo4	

	Belgien Belgium	Schweden Sweden	Spanien Spain	USA U.S.A.
	NBN	SS	UNE	AISI/SAE
	-	1350	F.111	1015
	C25-1	1450	F.112	1020
	C35-1	1550	F.113	1035
	C45-1	1650	F.114	1045
	C55-1	1655	-	1055
	C60-1	-	-	1060
	-	1912	11SMn28	1213
	-	1914	11SMnPb28	12L13
	-	-	10SPb20	-
	-	1957	F210G	1140
	-	-	12SMn35	1215
	-	1926	12SMn35	12L14
	55Si7	2085	56Si7	9255
	60SiCr8	-	60SiCr8	9262
	C16-2	1370	C15K	1015
	-	-	-	1039
	C25-2	-	-	1025
	-	2120	36Mn5	1335
	28Mn6	-	-	1330
	C36	1572	-	1035
	C45-2	1672	C45K	1045
	C55-2	-	C55K	1055
	C53	1674	-	1050
	C60-2	1678	-	1060
	-	1870	-	1095
	-	-	XG120Mn12	-
	-	2258	F.131	52100
	16Mo3	2912	16Mo3	ASTM A204Gr.A
	16Mo5	-	16Mo5	4520
	18Ni6	-	15Ni6	ASTM A350LF5
	10Ni36	-	XBNI09	ASTM A353
	12Ni20	-	-	2515
	-	-	-	3135
	-	-	15NiCr11	3415
	13NiCr12	-	-	3415;3310
	-	-	35NiCrMo4	9840
	-	2506	20NiCrMo2	8620
	40NiCrMo2	-	40NiCrMo2	8740
	35CrNiMo6	2541	-	4340
	17CrNiMo7	-	14NiCrMo13	-
	14NiCrMo132	-	14NiCrMo131	-
	15Cr2	-	-	5015
	34Cr4	-	35Cr4	5132
	42Cr4	-	42Cr4	5140
	-	2245	42Cr4	5140
	16MnCr5	2511	16MnCr5	5115
	55Cr3	-	-	5155
	25CrMo4	2225	55Cr3	4130
			AM26CrMo4	
	34CrMo4	2234	34CrMo4	4137;4135
	41CrMo4	2244	42CrMo4	4140;4142
	42CrMo4	2244	42CrMo4	4140

Vergleich ISO - zu ANSI - Kennzeichnung

Designation of indexable inserts:

Comparison ISO and ANSI

ISO	ANSI	ISO	ANSI
CCGT 060202	CCGT 2 (1.5) (.5)	DCGW 070202	DCGW 2 (1.5) (.5)
CCGT 060204	CCGT 2 (1.5) 1	DCGW 070204	DCGW 2 (1.5) 1
CCGT 09T302	CCGT 3 (2.5) (.5)	DCGW 11T304	DCGW 3 (2.5) 1
CCGT 09T304	CCGT 3 (2.5) 1	DCGW 11T308	DCGW 3 (2.5) 2
CCGT 120404	CCGT 431	DCMT 070202	DCMT 2 (1.5) (.5)
CCGT 120408	CCGT 432	DCMT 070204	DCMT 2 (1.5) 1
CCGW 060202	CCGW 2 (1.5) (.5)	DCMT 070208	DCMT 2 (1.5) 2
CCGW 060204	CCGW 2 (1.5) 1	DCMT 11T302	DCMT 3 (2.5) (.5)
CCGW 09T302	CCGW 3 (2.5) (.5)	DCMT 11T304	DCMT 3 (2.5) 1
CCGW 09T304	CCGW 3 (2.5) 1	DCMT 11T308	DCMT 3 (2.5) 2
CCGW 120404	CCGW 431	DCMT 150408	DCMT 432
CCGW 120408	CCGW 432	DCMT 150412	DCMT 433
CCMT 060202	CCMT 2 (1.5) (.5)	DCMW 11T304	DCMW 3 (2.5) 1
CCMT 060204	CCMT 2 (1.5) 1	DCMW 11T308	DCMW 3 (2.5) 2
CCMT 060208	CCMT 2 (1.5) 2	DNGA 150404	DNGA 431
CCMT 09T302	CCMT 3 (2.5) (.5)	DNGA 150408	DNGA 432
CCMT 09T304	CCMT 3 (2.5) 1	DNGA 150604	DNGA 441
CCMT 09T308	CCMT 3 (2.5) 2	DNGA 150608	DNGA 442
CCMT 120404	CCMT 431	DNMA 150608	DNM 442
CCMT 120408	CCMT 432	DNMG 110402	DNMG 330
CCMT 250924	CCMT 866	DNMG 110404	DNMG 331
CCMW 09T304	CCMW 3 (1.5) 1	DNMG 110408	DNMG 332
CCMW 120404	CCMW 431	DNMG 110412	DNMG 333
CCMW 120408	CCMW 432	DNMG 140405TL20	-
CNGA 120404	CNGA 431	DNMG 140405TL25	-
CNGA 120408	CNGA 432	DNMG 140405TR20	-
CNGA 120412	CNGA 433	DNMG 140405TR25	-
CNMA 120404	CNMA 431	DNMG 140410TL25	-
CNMA 120408	CNMA 432	DNMG 140410TL32	-
CNMA 120412	CNMA 433	DNMG 140410TR25	-
CNMG 090304	CNMG 321	DNMG 140410TR32	-
CNMG 090308	CNMG 322	DNMG 150404	DNMG 431
CNMG 120402	CNMG 430	DNMG 150408	DNMG 432
CNMG 120404	CNMG 431	DNMG 150412	DNMG 433
CNMG 120408	CNMG 432	DNMG 150416	DNMG 434
CNMG 120412	CNMG 433	DNMG 150604	DNMG 441
CNMG 120416	CNMG 434	DNMG 150608	DNMG 442
CNMG 160608	CNMG 542	DNMG 150612	DNMG 443
CNMG 160612	CNMG 543	DNMG 150616	DNMG 444
CNMG 160616	CNMG 544	DNMM 150408	DNMM 432
CNMG 190608	CNMG 642	DNMM 150412	DNMM 433
CNMG 190612	CNMG 643	DNMM 150608	DNMM 442
CNMG 190616	CNMG 644	DNMM 150612	DNMM 443
CNMM 120408	CNMM 432	RCGT 0602M0	-
CNMM 120412	CNMM 433	RCGT 0803M0	-
CNMM 120416	CNMM 434	RCGT 1003M0	-
CNMM 160612	CNMM 543	RCMT 0602M0	-
CNMM 160616	CNMM 544	RCMX 1003M0	-
CNMM 190612	CNMM 643	RCMX 1204M0	-
CNMM 190616	CNMM 644	RCMX 1606M0	-
CNMM 190624	CNMM 645	RCMX 2006M0	-
CNMX 120408	CNMX 432	RCMX 2507M0	-
CNMX 190612	CNMX 643	RCMX 3209M0	-
CNMX 190616	CNMX 644	SCGT 120408	SCGT 432
DCGT 070202	DCGT 2 (1.5) (.5)	SCGW 09T304	SCGW 3 (2.5) 1
DCGT 070204	DCGT 2 (1.5) 1	SCGW 09T308	SCGW 3 (2.5) 2
DCGT 11T302	DCGT 3 (2.5) (.5)	SCGW 120404	SCGW 431
DCGT 11T304	DCGT 3 (2.5) 1	SCGW 120408	SCGW 432
DCGT 11T308	DCGT 3 (2.5) 2		

Vergleich ISO - zu ANSI - Kennzeichnung
Designation of indexable inserts:
Comparison ISO and ANSI

ISO	ANSI	ISO	ANSI
SCMT 09T304	SCMT 3 (2.5) 1	TNMA 160404	TNMA 331
SCMT 09T308	SCMT 3 (2.5) 2	TNMA 160408	TNMA 332
SCMT 120404	SCMT 431	TNMA 160412	TNMA 333
SCMT 120408	SCMT 432	TNMA 220412	TNMA 433
SCMT 120412	SCMT 433	TNMG 160404	TNMG 331
SCMW 09T304	SCMW 3 (2.5) 1	TNMG 160408	TNMG 332
SCMW 120404	SCMW 431	TNMG 160412	TNMG 333
SNGA 120404	SNGA 431	TNMG 220408	TNMG 432
SNGA 120408	SNGA 432	TNMG 220412	TNMG 433
SNMA 120408	SNMA 432	TNMG 220416	TNMG 434
SNMA 120412	SNMA 433	TNMM 160408	TNMM 332
SNMA 190612	SNMA 643	TNMM 160412	TNMM 333
SNMA 190616	SNMA 644	TNMM 220408	TNMM 432
SNMG 090304	SNMG 321	TNMM 220412	TNMM 433
SNMG 120404	SNMG 431	TNMX 220412	TNMX 433
SNMG 120408	SNMG 432	TNUN 160408	TNUN 332
SNMG 120412	SNMG 433	TNUN 160412	TNUN 333
SNMG 120416	SNMG 434	TPGR 110304	TPGR 221
SNMG 150608	SNMG 542	TPGR 160308	TPGR 322
SNMG 150612	SNMG 543	TPMR 090204	TPMR 1.8 (1.5) 1
SNMG 150616	SNMG 544	TPMR 110304	TPMR 221
SNMG 190612	SNMG 643	TPMR 110308	TPMR 222
SNMG 190616	SNMG 644	TPMR 160304	TPMR 321
SNMM 120408	SNMM 432	TPMR 160308	TPMR 322
SNMM 120412	SNMM 433	TPMX 220412	-
SNMM 150612	SNMM 543	TPUN 110304	TPUN 221
SNMM 190612	SNMM 643	TPUN 110308	TPUN 222
SNMM 190616	SNMM 644	TPUN 160304	TPUN 321
SNMM 190624	SNMM 646	TPUN 160308	TPUN 322
SNMM 250716	SNMM 854	TPUN 160312	TPUN 323
SNMM 250724	SNMM 856	TPUN 220408	TPUN 432
SNMX 120408	SNMX 432	TPUN 220412	TPUN 433
SNMX 120412	SNMX 433	VBMT 160404	VBMT 331
SNUN 120412	SNUN 433	VBMT 160408	VBMT 332
SPMR 090304	SPMR 321	VBMT 160412	VBMT 333
SPMR 090308	SPMR 322	VCGT 110302	VCGT 220
SPMR 120304	SPMR 421	VCGT 110304	VCGT 221
SPMR 120308	SPMR 422	VCGT 160402	VCGT 330
SPMR 120312	SPMR 423	VCGT 160404	VCGT 331
SPUN 090308	SPUN 322	VCGT 160408	VCGT 332
SPUN 120304	SPUN 421	VCGT 160412	VCGT 333
SPUN 120308	SPUN 422	VCGT 220530	-
SPUN 120312	SPUN 423	VCMT 110302	VCMT 220
SPUN 150412	SPUN 533	VCMT 110304	VCMT 221
SPUN 190400	-	VCMT 160404	VCMT 331
SPUN 250620	SPUN 845	VCMT 160408	VCMT 332
TCGT 110204	TCGT 2 (1.5) 1	VCMT 160412	VCMT 333
TCGT 16T304	TCGT 3 (1.5) 1	VNMG 160404	VNMG 331
TCGW 110204	TCGW 2 (1.5) 1	VNMG 160408	VNMG 332
TCMT 110202	TCMT 2 (1.5) (.5)	VNMG 160408	VNMG 332
TCMT 110204	TCMT 2 (1.5) 1	VNMG 160412	VNMG 333
TCMT 110208	TCMT 2 (1.5) 2	VPGT 110304	VPGT 221
TCMT 16T304	TCMT 3 (2.5) 1	VPGT 160412	VPGT 333
TCMT 16T308	TCMT 3 (2.5) 2	VPGT 220516	-
TCMW 110202	TCMW 2 (1.5) (.5)	WCGT 06T302	WCGT 3 (2.5) (.5)
TCMW 110204	TCMW 2 (1.5) 1	WCGT 06T304	WCGT 3 (2.5) 1
TCMW 16T304	TCMW 3 (2.5) 1	WCGT 06T308	WCGT 3 (2.5) 2
TCMW 16T308	TCMW 3 (2.5) 2	WCGT 080404	WCGT 431
		WCGT 080408	WCGT 432

Härte-Vergleichstabelle
Hardness-comparison table

Zugfestigkeit Rm Tensile strength Rm N/mm ²	Vickers- härte Vickers hardness HV	Brinell- härte Brinell hardness HB	Rockwell- härte Rockwell hardness HRC
255	80	76	
270	85	80,7	
285	90	85,5	
305	95	90,2	
320	100	95	
335	105	99,8	
350	110	105	
370	115	109	
385	120	114	
400	125	119	
415	130	124	
430	135	128	
450	140	133	
465	145	138	
480	150	143	
495	155	147	
510	160	152	
530	165	156	
545	170	162	
560	175	166	
575	180	171	
595	185	176	
610	190	181	
625	195	185	
640	200	190	
660	205	195	
675	210	199	
690	215	204	
705	220	209	
720	225	214	
740	230	219	
755	235	223	
770	240	228	20,3
785	245	233	21,3
800	250	238	22,2
820	255	242	23,1
835	260	247	24
850	265	252	24,8
865	270	257	25,6
880	275	261	26,4
900	280	266	27,1
915	285	271	27,8
930	290	276	28,5
950	295	280	29,2
965	300	285	29,8
995	310	295	31
1030	320	304	32,2
1060	330	314	33,3
1095	340	323	34,4

Zugfestigkeit Rm Tensile strength Rm N/mm ²	Vickers- härte Vickers hardness HV	Brinell- härte Brinell hardness HB	Rockwell- härte Rockwell hardness HRC
1125	350	333	35,5
1155	360	342	36,6
1190	370	352	37,7
1220	380	361	38,8
1155	390	371	39,8
1290	400	380	40,8
1320	410	390	41,8
1350	420	399	42,7
1385	430	409	43,6
1420	440	418	44,5
1455	450	428	45,3
1485	460	437	46,1
1520	470	447	46,9
1555	480	(456)	47,7
1595	490	(466)	48,4
1630	500	(475)	49,1
1665	510	(485)	49,8
1700	520	(494)	50,5
1740	530	(504)	51,1
1775	540	(513)	51,7
1810	550	(523)	52,3
1845	560	(532)	53,0
1880	570	(542)	53,6
1920	580	(551)	54,1
1955	590	(561)	54,7
1995	600	(570)	55,2
2030	610	(580)	55,7
2070	620	(589)	56,3
2105	630	(599)	56,8
2145	640	(608)	57,3
2180	650	(618)	57,8
	660		58,3
	670		58,8
	680		59,2
	690		59,7
	700		60,1
	720		61
	740		61,8
	760		62,5
	780		63,3
	800		64
	820		64,7
	840		65,3
	860		65,9
	880		66,4
	900		67
	920		67,5
	940		68

Zugfestigkeit Tensile strength	N/mm ²	Rm
Vickershärte Vickers hardness	Diamantpyramide 136 , Prüfkraft F ≥ 98 N Diamond pyramid 136 , Test force F ≥ 98 N	HV
Brinellhärte Brinell hardness	0,102 x F/D2 = 30 N/mm ²	HB
Kalkuliert mit: Calculated from: HB = 0,95 x HV	F = Prüfkraft in N, D = Kegeldurchmesser in mm F = Test force in N, D= Cone diameter in mm	
Härte Rockwell C Hardness Rockwell C	Diamantkegel 120°, Gesamtprüfkraft 1471 ± 9 N Diamond cone 120°, Total test force 1471 ± 9 N	HRC

BOEHLERIT

Member of the LEITZ Group

Argentinien/Argentina

SIN PAR S.A.
Conesa 10
B1878KSB Quilmes -
Buenos Aires
Telefon +54 11 4257 4396
Telefax +54 11 4224 5687
ventas@sinpar.com.ar
www.sinpar.net
www.boehlerit.com

Brasilien/Brazil

Boehlerit Brasil Ferramentas Ltda.
Rua Capricórnio 72
Alpha Conde Comercial I
06473-005 - Barueri -
São Paulo
Telefon +55 11 554 60 755
Telefax +55 11 554 60 476
info@boehlerit.com.br
www.boehlerit.com

China/China

Boehlerit China Co. Ltd.
Swiss Center Shanghai
Room A107, Building 3
No. 526, 3rd East Fute Road
Shanghai Pilot Free Trade Zone
200131 P.R. China
Telefon +86 137 358 950 58
info@boehlerit.com.cn

Deutschland/Germany

Boehlerit GmbH & Co. KG
Werk VI-Strasse 100
8605 Kapfenberg
Österreich/Austria
Telefon +43 3862 300-0
Telefax +43 3862 300-793
info@boehlerit.com
www.boehlerit.com

Paul Horn GmbH
Unter dem Holz 33-35,
72072 Tübingen
Deutschland/Germany
Tel.: +49 7071-7004-0
Fax: +49 7071-72893
info@phorn.de
www.phorn.de

Großbritannien

United Kingdom
LMT UK Ltd
4202 Waterside Centre,
Solihull Parkway
B37 7YN Birmingham
Telefon +44 16 76 523440
Telefax +44 16 76 525379
lmt.uk@lmt-tools.com
www.lmt-uk.co.uk
www.boehlerit.com

Finnland/Finland

Oy Maantera AB
Keinumäenkuja 2, P.O. Box 70
01510 Vantaa
Telefon +358 29 006 130
Telefax +358 29 006 1130
maantera@maantera.fi
www.maantera.fi
www.boehlerit.com

Frankreich/France

Horn SAS
665 Av Blaise Pascal
77127 Lieusaint
Telefon +33 164 88 5958
Telefax +33 164 88 6049
infos@horn.fr
www.hornfrance.fr

Horn SAS
564 rue Claude Ballaloud
ZAE Bord d'Arve
74950 Scionzier
Telefon +33 4050 183148
Telefax +33 4050 182171
contact@horn.fr

Indien/India

LMT Fette (India) Pvt Ltd
29 (Old No. 14) II Main Road
Gandhinagar, Adyar
Chennai 600 020, India
Telefon +91 44 244 05 136
Telefax +91 44 244 05 205
lmt.in@lmt-tools.com
www.lmt-tools.com
www.boehlerit.com

Italien/Italy

Boehlerit Italy S.r.l.
Via Papa Giovanni XXIII, Nr. 45
20090 Rodano (MI)
Telefon +39 02 269 49 71
Telefax +39 02 218 72 456
info@boehlerit.it
www.boehlerit.com

Iran/Iran

Asia Tools Cutting Tools
Head Office Add: Unit 1,
3rd Floor, A Tower,
Tooba Complex,
Koohak Blvd, Chitgar Park,
Karaj Highway,
Tehran, IRAN
E: info@atd-co.com
W: www.atd-co.com
Telefon +98-21-460 848 20 / 2
Telefax +98-21-460 848 24

Kroatien/Bosnien & Herzegowina

Croatia/Bosnia & Herzegovina
Mikra d.o.o.
Bana J. Jelacica 25a
HR- 47250 Duga Resa
Telefon +385 47 84 47 41
Telefax +385 47 84 14 29
info@mikra-tools.com
www.mikra-tools.com

Mexiko/Mexico

Boehlerit S.A. de C.V.
Av. Acueducto No. 15
Parque Industrial Bernardo Quintana
El Marqués, Querétaro
México. C.P. 76246
Telefon +52 442 221 5706
Telefax +52 442 221 5555
info@boehlerit.com.mx
www.boehlerit.com

Niederlande/Netherlands

Hagro Precisie b.v.
Industriepark 18
NL-5374 CM Schaijk
Telefon +31 486 462 424
Telefax +31 486 461 650
hagro@hagro.nl
www.hagro.nl
www.boehlerit.com

BOEHLERIT GmbH & Co. KG

Werk VI-Strasse 100
8605 Kapfenberg
Österreich/Austria
Telefon +43 3862 300 - 0
Telefax +43 3862 300 - 793
info@boehlerit.com
www.boehlerit.com

Polen/Poland

Boehlerit Polska sp.z.o.o.
Zlotniki, ul. Kobaltowa 6
62-002 Suchy Las
Telefon +48 61 659 38 00
Telefax +48 61 623 20 14
info@boehlerit.pl
www.boehlerit.com

Russland/Russia

000 "Metin Group"
Skladochhnaya, 6
127018, Moscow
Telefon +7 495 921 1342
Telefax +7 495 921 1342
www.metingroup.ru
www.boehlerit.com

Schweden/Sweden

HORN Sverige & Danmark
Powered by JR TOOL ApS
Box 1902
SE-701 19 Örebro
Telefon + 46 19 / 277 76 06
Telefax +46 19 / 277 76 08
info@phorn.se
www.phorn.se
www.boehlerit.com

Schweiz/Switzerland

Vargus Werkzeugtechnik Snel AG
Knonauerstraße 56
6330 Cham 1
Telefon +41 41 784 21 21
Telefax +41 41 784 21 39
info@vargus.ch
www.vargus.ch
www.boehlerit.com

Singapur/Singapore

Boehlerit Asia Pte Ltd
1 Clementi Loop 04-01
Clementi West District Park
Singapore 12 98 08
Telefon +65 64 62 1608
Telefax +65 64 62 4215
info@boehleritasia.com
www.boehlerit.com

Slowakei/Slovakia

Werk VI-Strasse 100
8605 Kapfenberg
Österreich/Austria
Telefon +421 910 998 641
Telefax +421 42 444 3272
boehlerit@boehlerit.sk
www.boehlerit.sk
www.boehlerit.com

Slowenien/Slovenia

KAČ trade d.o.o.
Ložnica pri Žalcu 46
3310 Žalec
Telefon: +386 3 710 40 80
Telefax: +386 3 710 40 81
info@kactrade.si
www.kactrade.com
www.boehlerit.com

Spanien/Spain

Boehlerit Spain S.L.
C/. Narcis Monturiol 11-15
08339 Vilassar de Dalt Barcelona
Telefon +34 93 750 7907
Telefax +34 93 750 7925
info@boehlerit.es
www.boehlerit.com

Südkorea/South Korea

LMT Korea Co., Ltd
Room # 1520,
Anyang Trade Center
Bisan-Dong, Dongan-Gu
Anyang-Si, Gyeonggi-Do,
431-817, South Korea
Telefon +82 31 384 8600
Telefax +82 31 384 2121
lmt.kr@lmt-tools.com
www.lmt-tools.com
www.boehlerit.com

Tschechien

Czech Republic
Kancelár Boehlerit
Santraziny 753
760 01 Zlín
Telefon +420 577 214 989
Telefax +420 577 219 061
boehlerit@boehlerit.cz
www.boehlerit.cz
www.boehlerit.com

Türkei/Turkey

Böhler Sert Maden
ve Takım San. ve Tic. A.Ş.
Gebze Organize Sanayi Bölgesi
1600. Sk.No: 1602
41480 Gebze – Kocaeli
Telefon +90 262 677 1737
Telefax +90 262 677 1746
bohler@bohler.com.tr
www.boehler.com.tr
www.boehlerit.com

Ungarn/Hungary

Boehlerit Hungária Kft.
PO Box: 2036 Érdliget Pf. 32
2030-Érd, Kis-Duna u.6.
Telefon +36 23 521 910
Telefax +36 23 521 919
info@boehlerit.hu
www.boehlerit.com

USA

Kanada/Canada
Boehlerit USA
1140 No.Main St.
Lombard IL 60148
Telefon +1 847 734 9390
Telefax +1 847 734 9391
www.boehlerit.com